



FAN CLUTCH CATALOG

REBUILD KITS

REMANS

2-SPEED

VISCOUS

FANS



Fleetrite Fan Clutches

NAVISTAR™

Catalog Contents

Rebuild Kits - Air Engaged	3
Rebuild Kits - Spring Engaged	4
Rebuild Kits - 2-Speed	6
Kysor-Style - Remanufactured Front Air & Rear Air	8
Rebuild Kits - Front Air & Rear Air	9
Fan Blades - Identification Guide	11
Bendix Fan Clutches / HT650 Replacements	12
Fleetrite Modular Viscous Fan Clutches	13
Fan Clutch Controls	14
Recommended Shop Inventory	15
FLT244700 - "Clutch Pack" Applications	16

REMANUFACTURED FAN CLUTCHES

• Caterpillar®	17
• Cummins®	41
• Detroit Diesel®	67
• International®	78
• Mack®	80
• MCI Remote Mount®	82
• Mercedes-Benz®	83
• Paccar®	85
• Volvo®	86

CROSS REFERENCE

Horton®-Style Compatible	87
Viscous Fan Clutches	115
Bendix® Conversions & Rebuild Kits	121
Kysor®-Style Front Air/Rear Air	122
Fan Blades	125

DISCLAIMER

All of the pictures, specifications, descriptions, text and other data in this catalog have been carefully checked and researched with original manufacturers catalogs at the time of publication. We assume no responsibility should any information be deemed as incorrect, and reserve the right to make changes at any time without notice.

Manufacturer's names, symbols, numbers and descriptions are used for reference purposes only. It is not implied that any part listed is the product of these manufacturers.

NOTE: Any reference made herein to Ford®, GMC®, MCI®, Mack®, Mercedes Benz®, Freightliner®, Navistar®, International®, Volvo®, Paccar®, Peterbilt®, Western Star®, Kenworth®, Sterling®, Caterpillar®, Cummins®, Detroit®, Horton®, Kysor®, Bendix®, FD-3™, FD-L™, BorgWarner®, is purely for identification purposes only.

All of the above companies are registered trademarks or trade names of their respective companies. We do not intend to represent any parts shown as products manufactured by the above companies.

Rebuild Kits for Pre-2001 Air Engaged Fan Clutches



Fleetrite Part # **FLT9500HP**
9.5" HT/S Series

Features Include:

- U.S. Components and U.S. Manufactured
- Two Bearing Hub Design vs. One Bearing Hub Design
- Higher Quality Bearings
- Angular Contact Bearing
- Floating Return Spring vs. Captive Return Spring
- Higher Quality Lining
- Superior Fused Plate (Virgin Teflon vs. Lead)
- Superior O-Rings (Viton vs. NBR)
- All Wearable Components Are Always Replaced



Fleetrite Part # **FLT7500HP**
7.5" S Series

FLT4205 S & HT/S Series



Lining Kits



OEM Part #	Our Part #
994205	FLT4205
994207	FLT94207
994212	FLT7503
994245	FLT9505
994246	FLT9503
994305	FLT9500HP

OEM Part #	Our Part #
994306	FLT9505SP
994307	FLT7500HP
994308	FLT9500HP
994314	FLT7500HP
994315	FLT9500HP
994316	FLT9505HP

OEM Part #	Our Part #
994319	FLT9503
994321	FLT7503
994322	FLT9500HP
994323	FLT9500HP
994324	FLT7500HP
994325	FLT7500HP

OEM Part #	Our Part #
994370	FLT4205
994388	FLT9500HP
994389	FLT9500HP

Save Time & Money!

With the Ultimate Fan Clutch Rebuild Kit

The key reason for premature spring-engaged fan clutch failures is **LACK OF TORQUE**. There are fan blades in operation today that require more torque than current fan clutches can produce.

Our Spring-Engaged Rebuild Kit is unmatched by any competitors (new or remanufactured) & packs over

5,000 inch-pounds of Torque!



Highest Torque Rating

Sustaining fan blade engagement requires a large amount of torque. With over 5,000 inch-pounds of torque, our fan clutch will handle nearly all fan blades!

Less Time To Install

Our exclusive design combines nine separate components into **ONE FINAL ASSEMBLY** – this dramatically reduces installation time and installation errors.

Lower Cost

Upgrading your fan clutch is as simple as installing our rebuild kit.

- Lower cost vs. new
- Lower cost vs. reman
- Less failures
- Less time to install

Fail-Safe Design

Our innovative design will **AUTOMATICALLY ENGAGE** fan clutches when the friction material nears the end of its life.

COMPARE TO THE ALTERNATIVE

Our kit reduces nine components into one component assembly saving significant installation time and reducing the risk of installation errors



These four kits can rebuild nearly every spring-engaged fan clutch built after 2001. Upgrade now and you'll never want to use another fan clutch.

Fleetrite Part #
FLT14256

- 2.56" Fan Pilot
- 2 Pulley Bearings
- Easy to Install
- Kevlar® Impregnated Friction Material



Fleetrite Part #
FLT142561

Same as FLT14256, but with a single, 1.2" tall pulley bearing.



Fleetrite Part #
FLT14200

Same as FLT14256, but with a 2" Fan Pilot



Fleetrite Part #
FLT14500

Same as FLT14256, but with a 5" Fan Pilot



OEM Part#	Our Part #	Also Use
994346	FLT14S	
994347	FLT14256	
994349	FLT14L	
994353	FLT142561	FLT300SK
994356	FLT14200	
994373	FLT14256	FLT150SK
994375	FLT14256	FLT250SK
994377	FLT14256	FLT300SK
994379	FLT14256	FLT350SK
994381	FLT14256	FLT425SK

OEM Part#	Our Part #	Also Use
994383	FLT14200	
994385	FLT14200	FLT150SK
994387	FLT14200	FLT300SK
994900	FLT14256	
994902	FLT142561	
994966	FLT14SBL	
994985	FLT14256	
994995	FLT14256	FLT150SK
995031	FLT142561	
995033	FLT14SBL	

OEM Part#	Our Part #	Also Use
995034	FLT14256	
995035	FLT14256	
995037	FLT14256	FLT150SK
995042	FLT14256	FLT250SK
995046	FLT14L	
995052	FLT14256	FLT200SK
995053	FLT14256	FLT300SK
995054	FLT14256	
995055	FLT142561	FLT200SK
995056	FLT142561	FLT300SK

OEM Part#	Our Part #	Also Use
995057	FLT142561	FLT200SK
995058	FLT142561	FLT300SK
995062	FLT142561	FLT350SK
995063	FLT14256	FLT350SK
995530	FLT14256	
995534	FLT14256	FLT275SK
995567	FLT14256	
995568	FLT14256	
995575	FLT14256	
995586	FLT14256	FLT250SK

Kits to rebuild Horton® fan clutches



FLT14SBL
Seal, Bearing & Lining Kit



FLT14S
Seal Kit

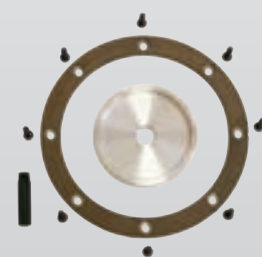

FLT14L
Lining Kit

*Our 2-Speed fan clutch is unmatched by any competitors
(new or remanufactured) & packs over
5,000 inch-pounds of Torque!*



Fleetrite Part #

FLT24256

Two 6209 bearings



Fleetrite Part #

FLT242561

Single 1.2" tall bearing

**OUR KIT CONTAINS
BOTH 2.56" & 5" FAN PILOTS**

Our 2-Speed's innovative design allows you to transform the standard 2.56" pilot into a 5" pilot (if needed) by simply installing a pilot adapter ring and six new fan studs (included). No need to replace your fan or buy a different 2-Speed kit.



2.56" Fan Pilot
(standard)



Easily converted to
5" Fan Pilot

Our ALL INCLUSIVE rebuild kit, eliminates the need to buy a separate bearing kit in addition to your fan clutch rebuild kit.

OEM Kit#	OEM Bearing Kit #	Fleetrite#	OEM Kit#	OEM Bearing Kit #	Fleetrite#	OEM Kit#	OEM Bearing Kit #	Fleetrite#
995509	-	FLT24256	995559	-	FLT242561	995620	+ 995566	FLT24256
995510	-	FLT24256	995582	-	FLT24256	995620	+ 995584	FLT24256
995511	-	FLT242561	995591	+ 995550	FLT24256	995620	+ 995574	FLT24256
995527	-	FLT242561	995591	+ 995566	FLT24256	995620	+ 995548	FLT242561
995543	+ 995550	FLT24256	995591	+ 995584	FLT24256	995621	+ 995550	FLT24256
995543	+ 995566	FLT24256	995591	+ 995574	FLT24256	995621	+ 995566	FLT24256
995543	+ 995584	FLT24256	995591	+ 995548	FLT242561	995621	+ 995584	FLT24256
995543	+ 995574	FLT24256	995592	+ 995550	FLT24256	995621	+ 995574	FLT24256
995543	+ 995548	FLT242561	995592	+ 995566	FLT24256	995621	+ 995548	FLT242561
995547	+ 995550	FLT24256	995592	+ 995584	FLT24256	995622	-	FLT242561
995547	+ 995566	FLT24256	995592	+ 995574	FLT24256	995623	-	FLT24256
995547	+ 995584	FLT24256	995592	+ 995548	FLT242561	995624	-	FLT24256
995547	+ 995574	FLT24256	995617	-	FLT24256			
995547	+ 995548	FLT242561	995620	+ 995550	FLT24256			

If your OEM kit number is followed by one of the following numbers, also use the appropriate stud kit (ex: 995547-200 requires Stud Kit FLT150SK):

OEM	Use Stud Kit #	OEM	Use Stud Kit #	OEM	Use Stud Kit #	OEM	Use Stud Kit #
-200	FLT150SK	-275	FLT250SK	-350	FLT300SK	-475	FLT400SK
-250	FLT200SK	-300	FLT275SK	-400	FLT350SK		

Why use a 2-Speed fan clutch instead of an on/off fan clutch?

In vocational applications, where the fan clutch engagement time exceeds 10% of the engine run time, **SWITCH TO a 2-Speed fan clutch to save horsepower and fuel.**

In a 2-Speed fan clutch, when the fan clutch is disengaged, the fan still rotates at between 15% and 25% of the engine RPM, this fan rotation provides crucial airflow to the engine and **draws virtually no horsepower.**

COOL WITHOUT LOSING HORSEPOWER

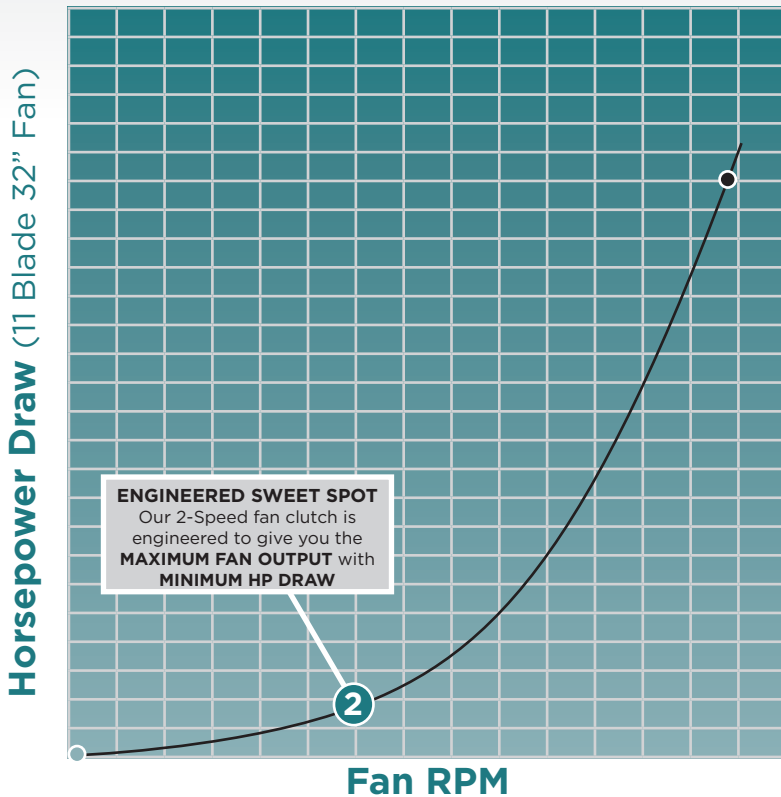

- Fan speed when on/off fan clutch is OFF = 80RPM • HP Draw = 0.02
- ② Fan speed when 2-Speed fan clutch is OFF = 300RPM • HP Draw = 0.14
- Fan speed when fan clutch is fully engaged = 1800RPM • HP Draw = 65

*Data based on engine speed of 1800 RPM.



BENEFITS OF CONVERTING TO A 2-SPEED FAN CLUTCH

Horsepower Savings

A fully engaged fan clutch absorbs a massive amount of horsepower. Fewer fan clutch engagements will recapture that lost power.

Improved Fuel Economy

It takes horsepower to drive a fan blade. As you recapture your lost horsepower, you improve fuel economy.

HORSEPOWER SAVED = FUEL MILEAGE EARNED

Longer Fan Clutch Life

A fan clutch has in its life a given amount of engagements. When engaged 10% of the time or less it should last 4-6 years. Increasing engagement cycles reduces life. Providing constant cooling means reducing engagement cycles and this will improve the life of the fan clutch, fan belts and belt tensioner.

Lower Under-Hood Temperatures

Excessive heat causes stress on your engine and its components. The viscous engagement of our 2-speed provides continual air flow and constant cooling.

Driver Comfort

A fully engaged fan clutch makes a lot of noise. Fewer engagements will improve driver comfort, a key factor in driver retention.

Easy Installation

With fewer individual components, installation is a breeze.

Reduce the Frequency of Fan Clutch Engagements

Provide constant air flow without robbing horsepower by utilizing approximately a 15-25% Viscous Engagement. The 2-Speed fan clutch delivers crucial CFM to the engine compartment, keeping a more consistent engine temperature with fewer full fan clutch engagements.

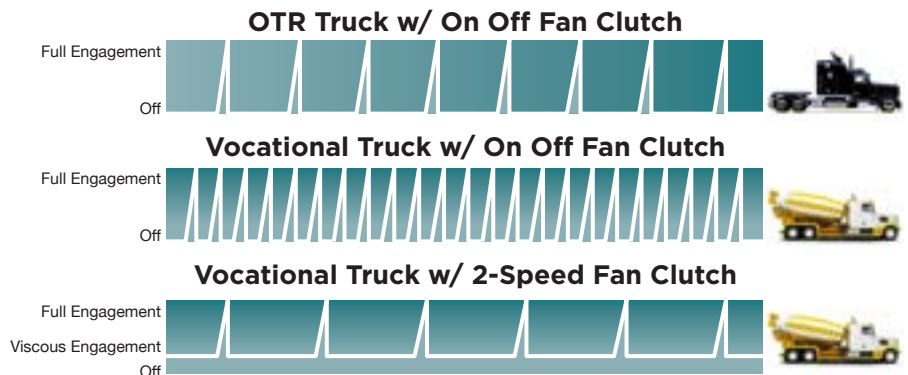

The High-Torque FLT8801N

Long-lasting friction plus our two o-ring shaft combine for ultimate performance

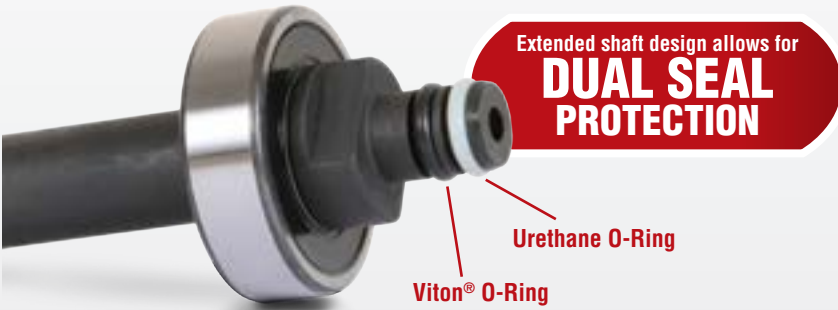

Two O-Rings are Better than One!

Our extended shaft allows for the addition of a urethane o-ring for resilience to motion, and a Viton® o-ring to create a superior air barrier.

- Torque Rated for 30" Fans and Larger
- Redesigned Shaft for Dual Seal Protection
- Dual fan pilot to cover more applications
- Superior O-Ring Materials
- Higher Quality Lining
- Truer Air Shaft

Always improving

Our ON/OFF fan clutch is the highest torque rated Kysor-style replacement on the market. The FLT8801N can replace K22, K26, K30 AND K32 rear air fan clutches!

ALUMINUM K-SERIES PROBLEM SOLVED!

BONDED LINING KIT

Fleetrite Part #
FLT8800BL

Using a new, **bonded friction** design, the FLT8800BL lining kit solves the premature wear issue in aluminum body Kysor-Style fan clutches.

Use to rebuild fan clutch numbers:
1090-09900-01 • 1090-09950-01



By bonding the friction material to ring, we have eliminated the aluminum housing as a wear point, which prevents damage to the fan clutch.

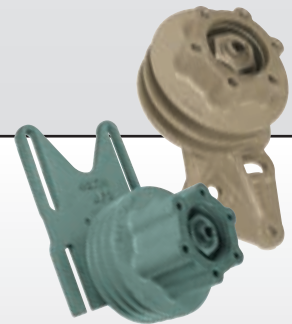

**We Stock
REAR-AIR
HUBS**

Call for Availability

See page 122 for hub identification guide

FLT8001X Fleetrite Part Number Front Air Rebuild with kit # FLT8000SKL

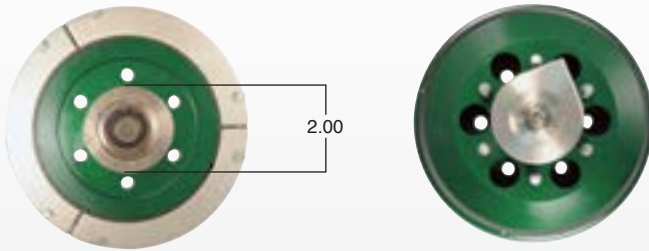

FLT8005X Fleetrite Part Number Front Air Rebuild with kit # FLT8000SKL

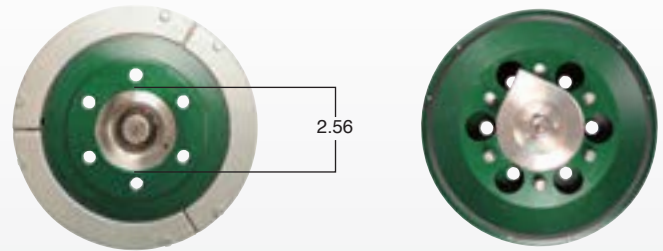

FLT8801N Fleetrite Part Number Rear Air Rebuild with kit # See chart

Most common 2003-Present

Has both 2.56" & 5" fan pilot

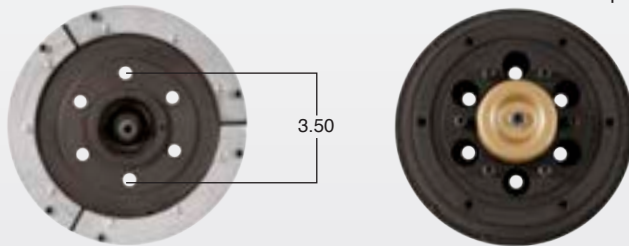

FLT8802X Fleetrite Part Number Rear Air Rebuild with kit # FLT8500SKL

No Studs with threaded 5/16 holes

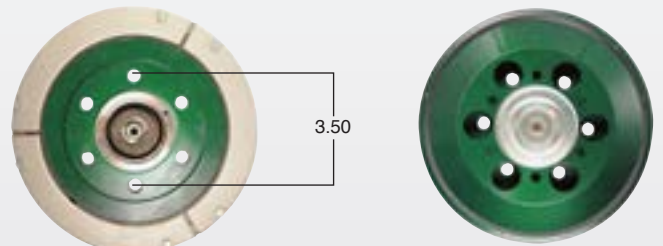

FLT8803X Fleetrite Part Number Rear Air Rebuild with kit # FLT8800SKL

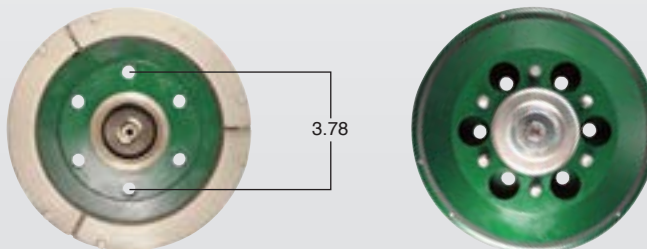

OEM #	Fleetrite #	Use Kit #	OEM Style	Notes
1090-07050-01	FLT8001N	N/A	FA	Replace Only
1090-07050-03	FLT8005X	N/A	FA	Replace Only
1090-08000-01	FLT8001X	FLT8000SKL	K-22 FA	
1090-08000-05	FLT8005X	FLT8000SKL	K-22 FA	Mack® Application Only
1090-08500-01	FLT8801N	FLT8500SKL	K-22 RA	Most Common
1090-08500-02	FLT8802X	FLT8500SKL	K-22 RA	Used on some Fords®
1090-08500-03	FLT8803X	FLT8500SKL	K-22 RA	Used on some Fords®
1090-09000-01	FLT8001X	FLT8026SKL	K-26 FA	
1090-09000-05	FLT8005X	FLT8026SKL	K-26 FA	
1090-09500-01	FLT8801N	FLT8800SKL	K-26 RA	K-26
1090-09500-03	FLT8803X	FLT8800SKL	K-26 RA	
1090-09600-01	FLT8801N	FLT8800SKL	K-30 RA	Use FLT8801N unless on Mack®
1090-09650-01	FLT8801N	FLT8800SKL	K-32 RA	
1090-09900-01	FLT8801N	FLT8800SKBL	K-30 RA	5" Fan Pilot - Aluminum Body
1090-09950-01	FLT8801N	FLT8800SKBL	K-32 RA	5" Fan Pilot - Aluminum Body
9908500	FLT8801N	FLT8800SKL	K-22 RA	
9908501	FLT8801N	FLT8800SKL	K-26 RA	

Seal & Lining Kits



Our Part #	OEM #
FLT8000SKL - Front Air For K-22 Front Air Fan Clutches	1033-05435-02
FLT8500SKL - Rear Air For K-22 Rear Air Fan Clutches	1033-05435-03
FLT8800SKL - Rear Air For K-26, K-30 & K-32 Fan Clutches	1033-09339-01
FLT8800SKBL - Rear Air For Aluminum Body K-30 & K-32	

Seal Kits



Our Part #	OEM #
FLT8000SK - Front Air For K-22 Front Air Fan Clutches	
FLT8800SK - Rear Air For K22, K-26, K-30 & K-32 Rear Air Fan Clutches	1033-08233-01

Lining Kits

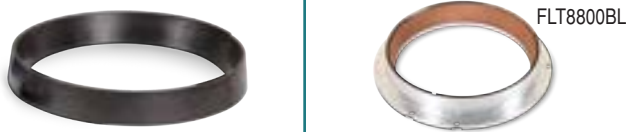

Our Part #	OEM #
FLT8500L For K-22 Fan Clutches	1033-08233-01
FLT8800L For K-26 & K-30 Rear Air Fan Clutches	1033-09340-01
FLT8800BL For Aluminum Body K-30 & K-32	

Hub Bearing Kits

When replacing your fan clutch, you should also
* replace the pulley bearings. *

Our Bearing Kit Part #	OEM #
FLT8581-01	1033-07781-01
FLT8582-01	1033-07782-01
FLT8582-02	1033-07782-02
FLT8582-03	1033-07782-03
FLT8582-04	1033-07782-04

These five bearing kits will repair all rear-air hubs.
Replacing the hub bearings will ensure longer fan clutch life.



FLT8581-01
Most popular bearing
kit for rear-air hubs



FLT8582-01



FLT8582-02



FLT8582-03



FLT8582-04

HOW TO IDENTIFY YOUR FAN BLADE

If you cannot find a part number on your fan blade, simply gather the following information:

1. ROTATION

Place your fan engine side down on the floor/counter. Look at the blade that is in the 12 o'clock position. One side of the blade will be resting on the floor and one side will be raised.

- If the Right side is raised, your fan is Clockwise.
- If the Left side is raised, your fan is CounterClockwise.

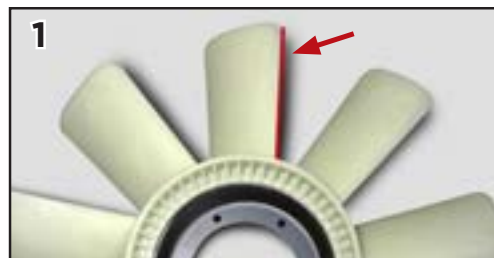

2. NUMBER OF BLADES

Simply count the number of blades. Available options range from 6 to 11 blades.

3. PROJECTED WIDTH (PITCH)

Place your fan engine side down on the floor/counter. Measure the distance from the floor/counter to the highest point of an undamaged blade.

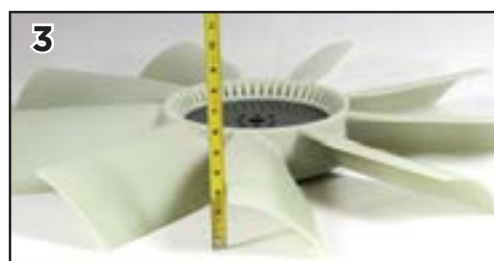

4. FAN PILOT

Measure the opening of the center fan plate using a caliper. If the fan pilot is lemon shaped (see photo 4a) your pilot will always measure 2.56". You will need to specify the lemon-shaped pilot when ordering. Choose one of the following:

- | | | |
|-------|----|-------|
| 1" | 2" | 2.05" |
| 2.56" | 5" | |

These are the most common pilot sizes - other sizes available.

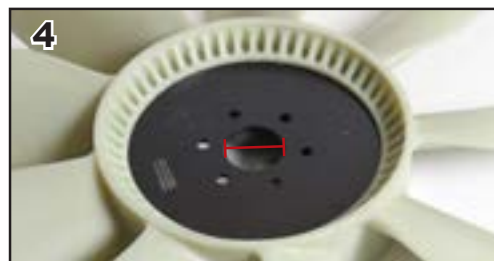

5. FAN DIAMETER

Measure the overall diameter of your fan at its widest point.

6. BACK TO BACK (DISH)

Place your fan engine side down on the counter/floor. Put a tape measure through the pilot hole and measure the distance from the floor/counter up to the bottom of the fan plate in the center.



Once you have gathered this information, contact your Fleetrite dealer to determine a part number.

For fan blade cross-reference information, see page 125



HT550® / HT650® CONVERSIONS

FLT8009X, FLT 8010X & FLT8015X are direct replacements/upgrades for Mack® applications of the HT650®/HT550® fan clutches.*



THEIRS



OURS

OEM #	Fleetrite #
981418	FLT8011X
981419	FLT8011X
981420	FLT8011X
981442	FLT8009X
981446	FLT8009X
991400	FLT8011X
991402	FLT8011X
991405	FLT8011X
991419	FLT8011X
991420	FLT8011X
991428	FLT8009X
991435	FLT8009X
991439	FLT8009X
991445	FLT8010X
991446	FLT8011X
991450	FLT8010X
991451	FLT8009X
991454	FLT8015X

*When converting from HT650®/550®, reverse solenoid valve to air-to-disengage instead of air-to-engage.

Premium Remanufactured BENDIX®-STYLE FAN CLUTCHES

- All Wearable Components Are ALWAYS Replaced
- Upgraded Seal Materials and Bearings





Nearly Every Medium/Heavy Duty Viscous Fan Drive **IN STOCK NOW!**

51 INTERCHANGEABLE BRACKETS



EQUALS THOUSANDS OF PARTS!

By using several universal viscous heads, along with interchangeable brackets and adapters, we've narrowed the field of viscous fan drives from over 1,000 part numbers, down to just a few components. This unprecedented system makes it possible to have access to a replacement for nearly every viscous fan drive.

Unparalleled Viscous Inventory

By using the Fleetrite Modular Viscous Fan Drive system, distributors have the ability to **build thousands of different**

Viscous Clutches ON DEMAND!

This simple system requires a limited amount of inventory that is all held in this mobile display cart.



THERMAL SWITCHES



PART#	DESCRIPTION	OEM#
FLT3611	185°Normally Open / Normally Closed Thermal Switch (3/8" Thread - 3 terminals)	993611
FLT3616	185°Normally Open Thermal Switch (1/2" Thread)	993616
FLT3619	185°Normally Closed Thermal Switch (1/2" Thread)	993619
FLT3617	190°Normally Open Thermal Switch (1/2" Thread)	993617
FLT3603	190°Normally Closed Thermal Switch (1/2" Thread)	993603
FLT3653	195°Normally Open Thermal Switch (1/2" Thread) used on most Cummins®	993653
FLT3605	195°Normally Closed Thermal Switch (1/2" Thread) used on most Cummins®	993605
FLT3654	200°Normally Open Thermal Switch (1/2" Thread) used on most Detroit Diesel®	993654
FLT3606	200°Normally Closed Thermal Switch (1/2" Thread) used on most Detroit Diesel®	993606
FLT3655	205°Normally Open Thermal Switch (1/2" Thread) used on most Caterpillar®	993655
FLT3607	205°Normally Closed Thermal Switch (1/2" Thread) used on most Caterpillar®	993607
FLT3624	210°Normally Open Thermal Switch (1/2" Thread)	993624
FLT3684	210°Normally Closed Thermal Switch (1/2" Thread)	993684
FLT3625	215°Normally Open Thermal Switch (1/2" Thread)	993625
FLT3685	215°Normally Closed Thermal Switch (1/2" Thread)	N/A
FLT3626	220°Normally Open Thermal Switch (1/2" Thread)	993626
FLT3665	220°Normally Closed Thermal Switch (1/2" Thread)	993665

SOLENOID VALVES

PART#	DESCRIPTION	OEM#
FLT3282	3-way Solenoid Valve NO-NC 125NPTF, 12VDC	993282
FLT3283	3-way Solenoid Valve NO-NC 125NPTF, 24VDC	993283

FLT3282 and FLT3283 3-way Solenoid Valves can be plumbed either Normally Open or Normally Closed.

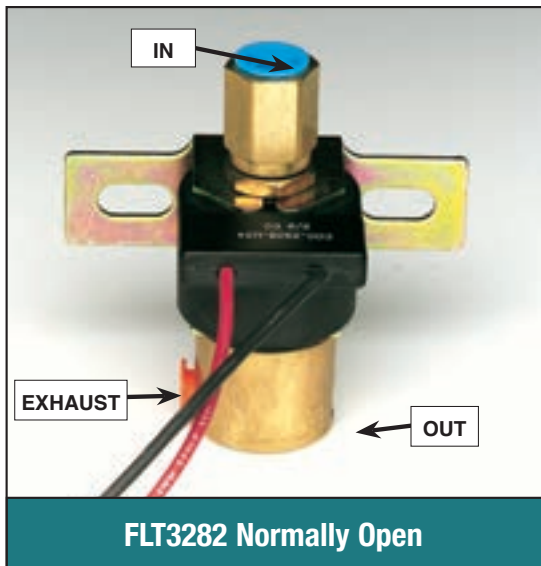

Used with air engaged fan clutches with Normally Closed Thermal Switch, or use with all spring engaged fan clutches.

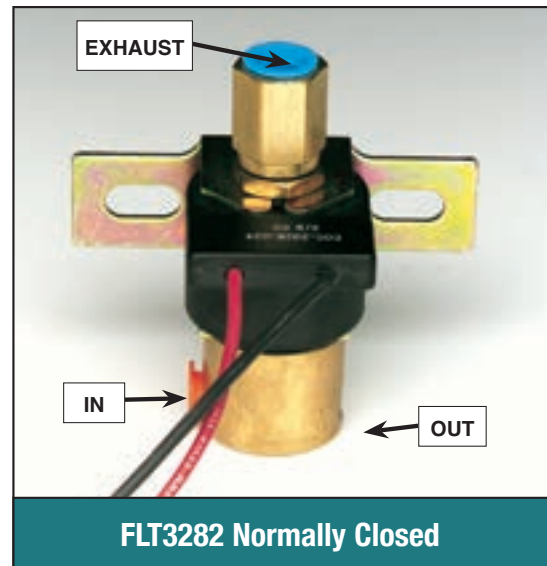

Used with air engaged fan clutches with Normally Open Thermal Switch.

With these products on hand, you can rebuild or replace over 95% of all heavy duty fan clutches in operation today!



Part # **FLT24256**



Part # **FLT14256**



Part # **FLT7500HP** - 7.5" S Series



Part # **FLT9500HP** - 9.5" HT/S Series



Part # **FLT8801N**



Part # **FLT858101**



COMPATIBLE WITH INTERNATIONAL™ “CLUTCH PACK” APPLICATIONS

Part # FLT244700



Unlike standard, all-in-one fan clutches, some specific International applications have a unique modular system. **This system requires the fan clutch to be disassembled and re-installed component by component.**

THE PROBLEM:

The pulleys on these particular fan clutches have a **flat front** that does not allow for a typical rebuild kit.

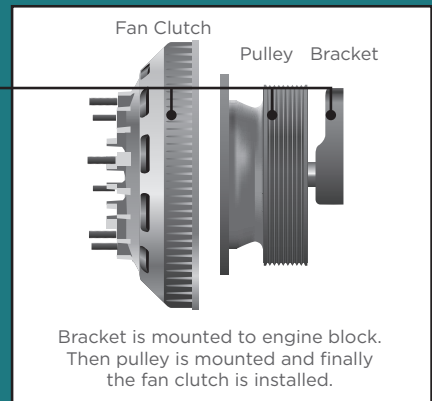
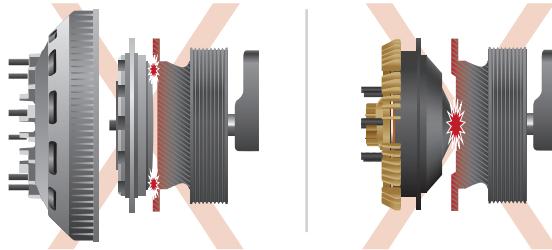

The OEM requires that you purchase a separate complete rebuild kit (clutch pack) that they have made specifically for this application.

THE SOLUTION:

Instead of creating a separate rebuild kit, we have created a unique **riser plate** that allows for the installation of our standard ON/OFF or 2-Speed kit.

- Inexpensive compared to complete rebuild kit
- Does not change the overall dimensions
- Includes adapter ring to cover multiple applications

* Installation of the FLT244700 also requires a unique extended air cartridge (included).

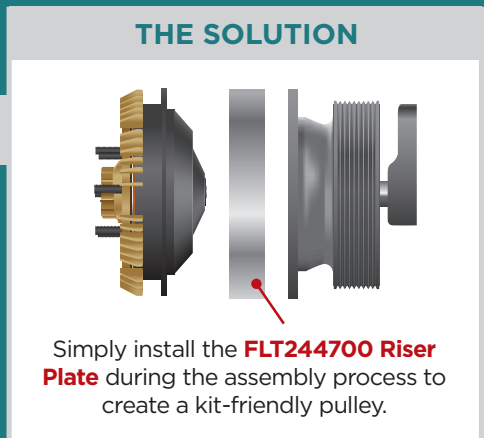

FLT90005 Fleetrite Part Number

Rebuild with kit # FLT7500HP

7.5" Friction Plate

2" Fan Pilot

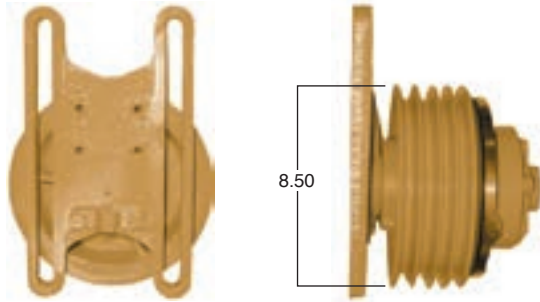

FLT90007 Fleetrite Part Number

Rebuild with kit # FLT7500HP

7.5" Friction Plate

2" Fan Pilot

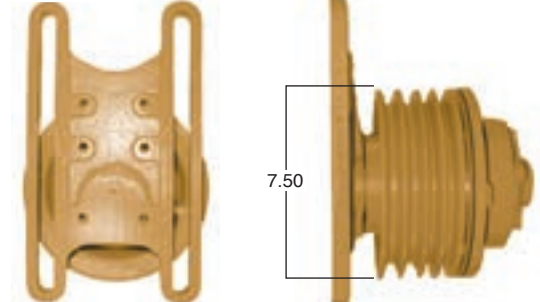

FLT90014 Fleetrite Part Number

Rebuild with kit # FLT7500HP

7.5" Friction Plate

5" Fan Pilot

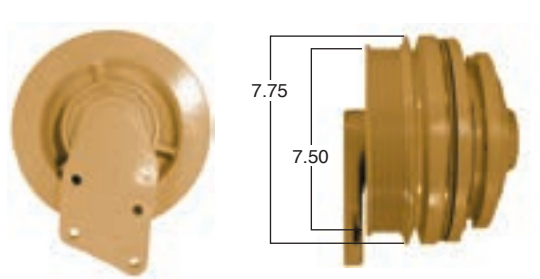

FLT90015 Fleetrite Part Number

Rebuild with kit # FLT7500HP

7.5" Friction Plate

2" Fan Pilot

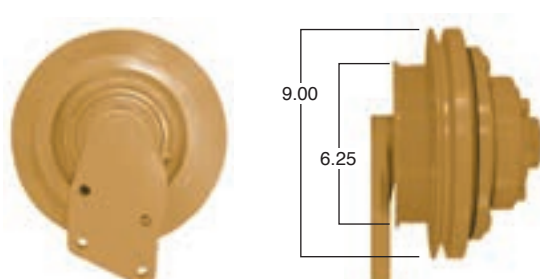

FLT90022 Fleetrite Part Number

Rebuild with kit # FLT7500HP

7.5" Friction Plate

2" Fan Pilot

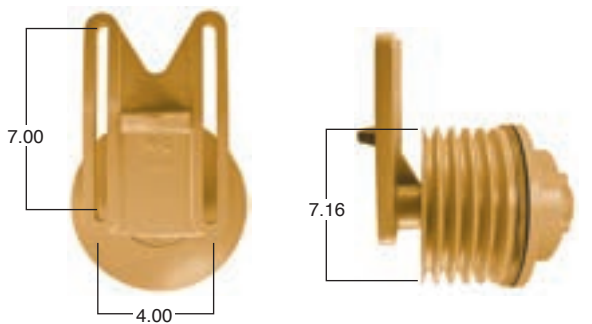

FLT90028 Fleetrite Part Number

Rebuild with kit # FLT7500HP

7.5" Friction Plate

2" Fan Pilot

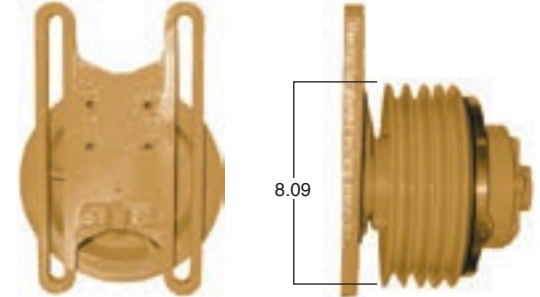

FLT90030 Fleetrite Part Number

Rebuild with kit # FLT7500HP

7.5" Friction Plate

2" Fan Pilot

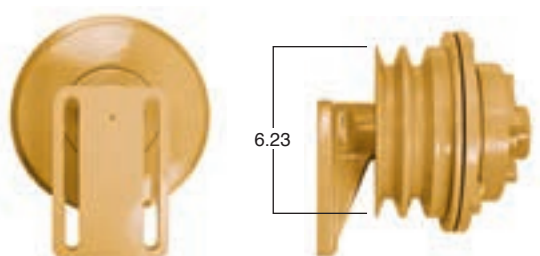

FLT91002 Fleetrite Part Number

Rebuild with kit # FLT9500HP

9.5" Friction Plate

2" Fan Pilot

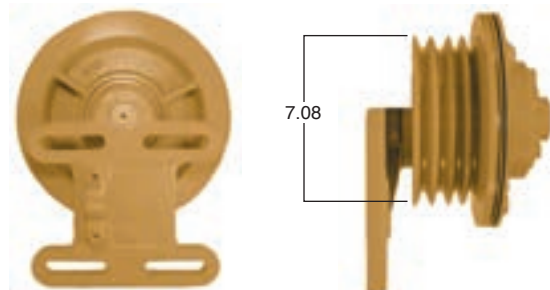

FLT91003

Fleetrite Part Number

Rebuild with kit # FLT9505SP

9.5" Friction Plate

2" Fan Pilot

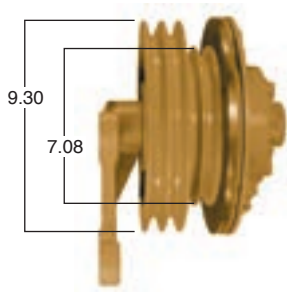

FLT91005

Fleetrite Part Number

Rebuild with kit # FLT9500HP

9.5" Friction Plate

2" Fan Pilot

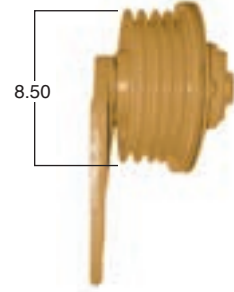
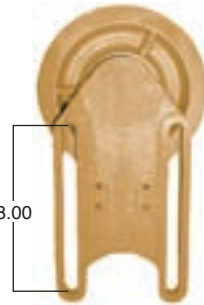

FLT91007

Fleetrite Part Number

Rebuild with kit # FLT9500HP

9.5" Friction Plate

2" Fan Pilot

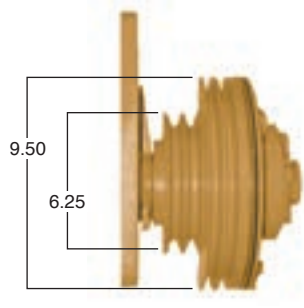

FLT91008

Fleetrite Part Number

Rebuild with kit # FLT9500HP

9.5" Friction Plate

2" Fan Pilot

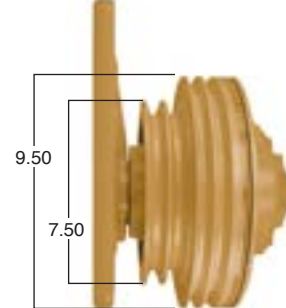

FLT91012

Fleetrite Part Number

Rebuild with kit # FLT9505SP

9.5" Friction Plate

5" Fan Pilot
(2" Fan Pilot - Contact Distributor)

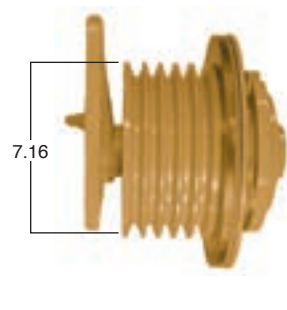
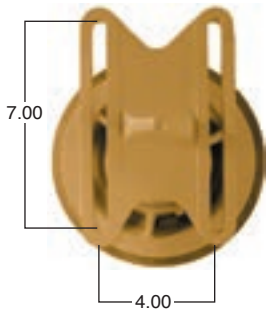

FLT91013

Fleetrite Part Number

Rebuild with kit # FLT9500HP

9.5" Friction Plate

5" Fan Pilot

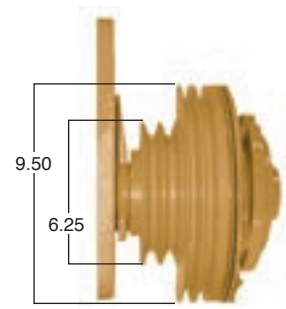

FLT91014

Fleetrite Part Number

Rebuild with kit # FLT9500HP

9.5" Friction Plate

2" Fan Pilot

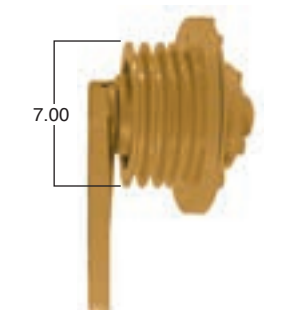
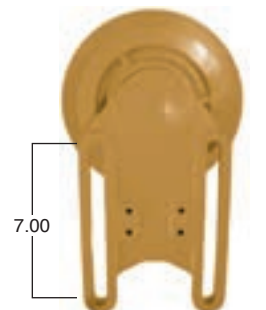

FLT91015

Fleetrite Part Number

Rebuild with kit # FLT9500HP

9.5" Friction Plate

5" Fan Pilot

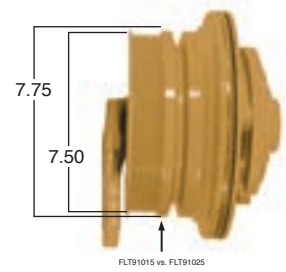

FLT91017 Fleetrite Part Number

Rebuild with kit # 9505SP

9.5" Friction Plate

2" Fan Pilot

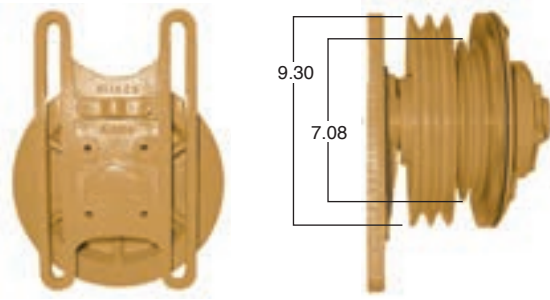

FLT91020 Fleetrite Part Number

Rebuild with kit # FLT9500HP

9.5" Friction Plate

2" Fan Pilot

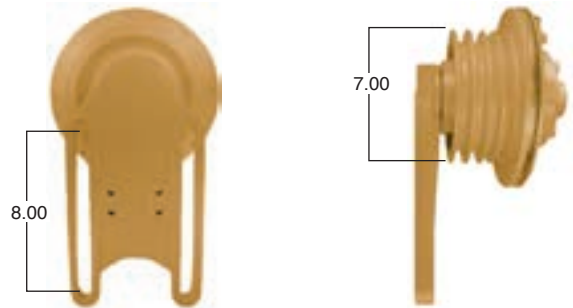

FLT91025 Fleetrite Part Number

Rebuild with kit # FLT9500HP

9.5" Friction Plate

5" Fan Pilot

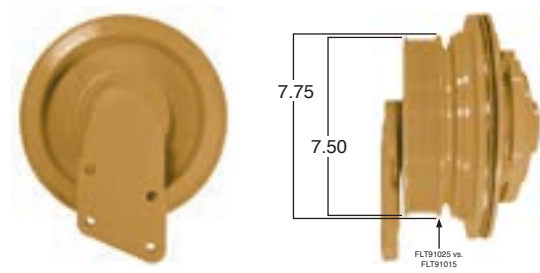

FLT91027 Fleetrite Part Number

Rebuild with kit # FLT9500HP

9.5" Friction Plate

2" Fan Pilot

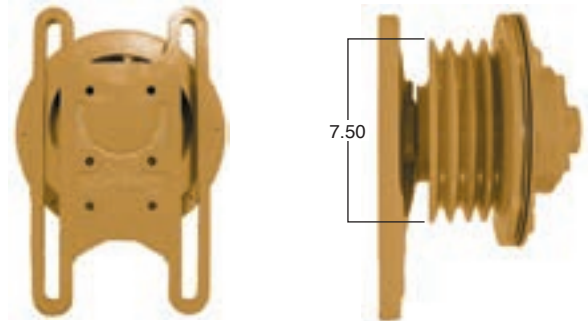

FLT91028 Fleetrite Part Number

Rebuild with kit # FLT9500HP

9.5" Friction Plate

2" Fan Pilot

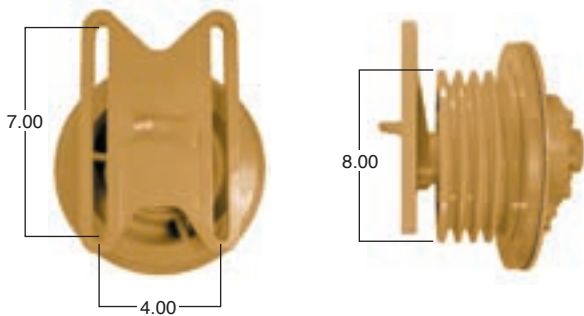

FLT91035 Fleetrite Part Number

Rebuild with kit # FLT9500HP

9.5" Friction Plate

2" Fan Pilot

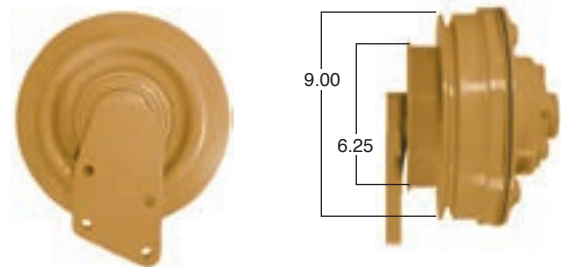

FLT91038 Fleetrite Part Number

Rebuild with kit # FLT9500HP

9.5" Friction Plate

5" Fan Pilot

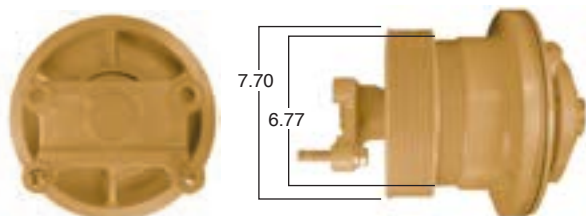

FLT91048 Fleetrite Part Number

Rebuild with kit # FLT9500HP

9.5" Friction Plate

2.56" Fan Pilot

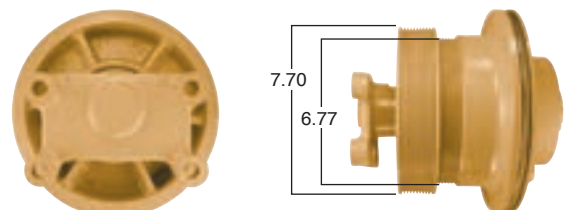

FLT91049

Fleetrite
Part Number

Rebuild with kit #
FLT9500HP

9.5" Friction Plate

2.56" Fan Pilot

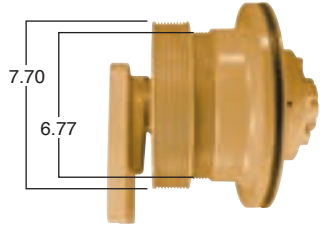

FLT91051

Fleetrite
Part Number

Rebuild with kit #
FLT9500HP

9.5" Friction Plate

2.56" Fan Pilot

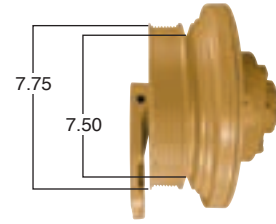

FLT91057

Fleetrite
Part Number

Rebuild with kit #
FLT9500HP

9.5" Friction Plate

2.56" Fan Pilot

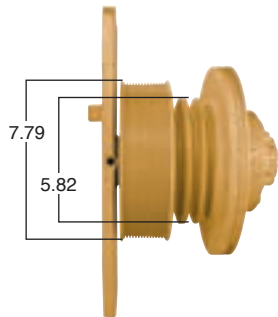

FLT91059

Fleetrite
Part Number

Rebuild with kit #
FLT9500HP

9.5" Friction Plate

2.56" Fan Pilot

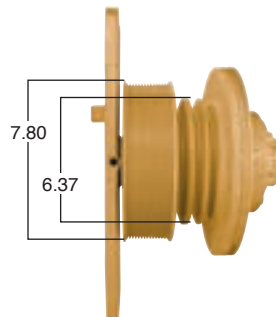

FLT91060

Fleetrite
Part Number

Rebuild with kit #
FLT9500HP

9.5" Friction Plate

2.56" Fan Pilot

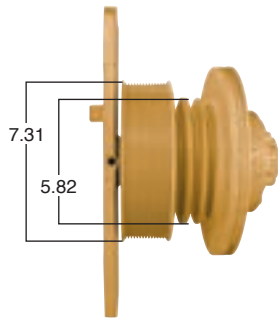

FLT91063

Fleetrite
Part Number

Rebuild with kit #
FLT9500HP

9.5" Friction Plate

5" Fan Pilot

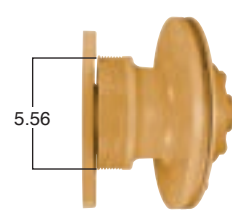
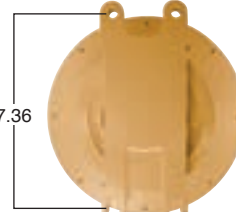

FLT91066

Fleetrite
Part Number

Rebuild with kit #
FLT9500HP

9.5" Friction Plate

2" Fan Pilot

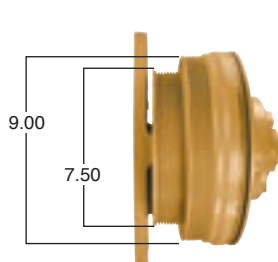

FLT91067

Fleetrite
Part Number

Rebuild with kit #
FLT9500HP

9.5" Friction Plate

5" Fan Pilot

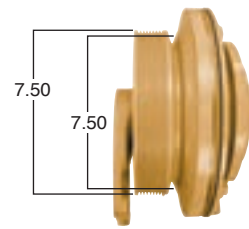

FLT91068 Fleetrite Part Number

Rebuild with kit # FLT9500HP

9.5" Friction Plate

2" Fan Pilot

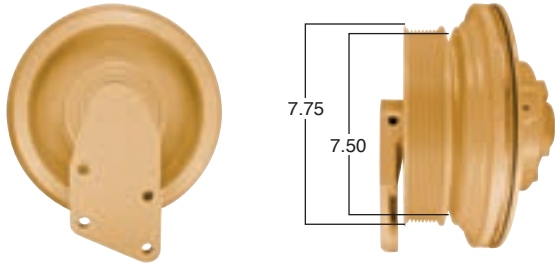

FLT91069 Fleetrite Part Number

Rebuild with kit # FLT9500HP

9.5" Friction Plate

2" Fan Pilot
Same as FLT91070

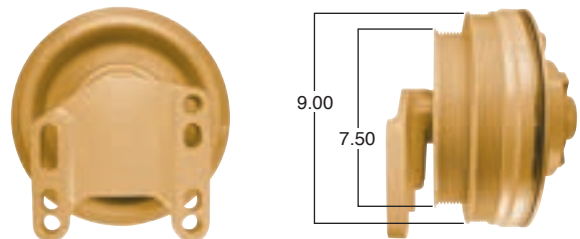

FLT91070 Fleetrite Part Number

Rebuild with kit # FLT9500HP

9.5" Friction Plate

2" Fan Pilot
Same as FLT91069

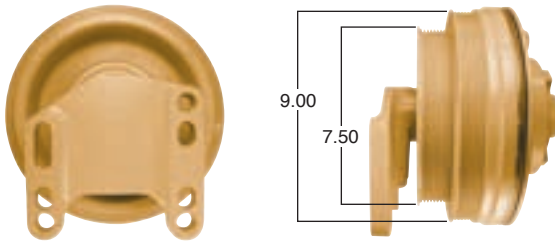

FLT91071 Fleetrite Part Number

Rebuild with kit # FLT9500HP

9.5" Friction Plate

2" Fan Pilot

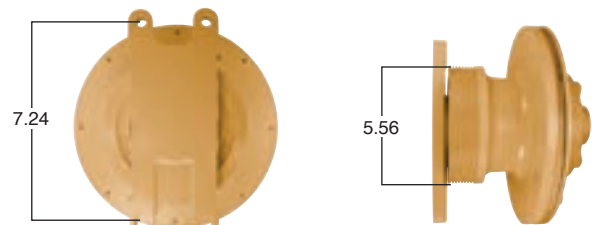

FLT91076 Fleetrite Part Number

Rebuild with kit # FLT9500HP

9.5" Friction Plate

5" Fan Pilot

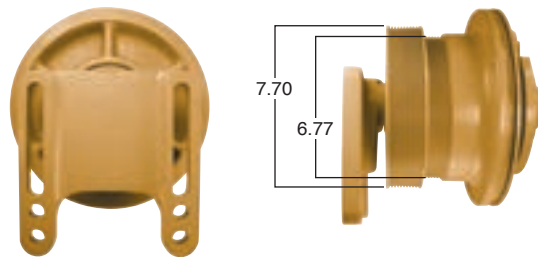

FLT91081 Fleetrite Part Number

Rebuild with kit # FLT9500HP

9.5" Friction Plate

2" Fan Pilot

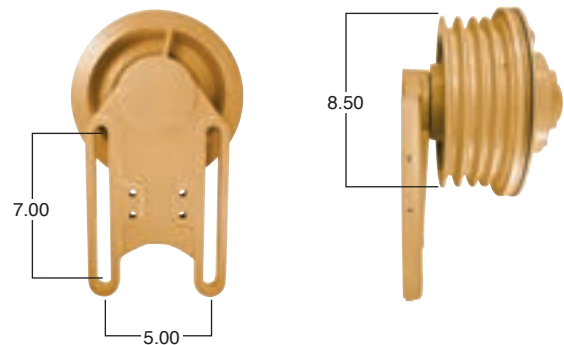

FLT91082 Fleetrite Part Number

Rebuild with kit # FLT9500HP

9.5" Friction Plate

2" Fan Pilot

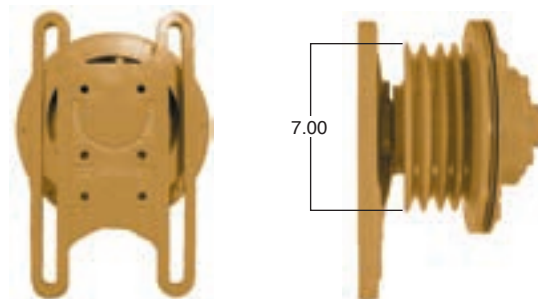

FLT91085 Fleetrite Part Number

Rebuild with kit # FLT9500HP

9.5" Friction Plate

2" Fan Pilot

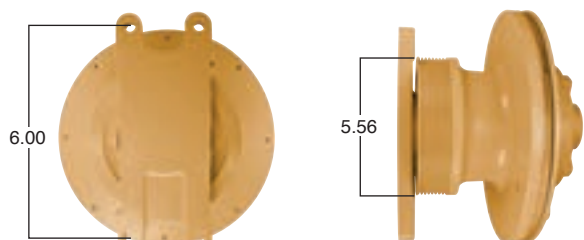

FLT91087

Fleetrite
Part Number

Rebuild with kit #
FLT9500HP

9.5" Friction Plate

2.56" Fan Pilot

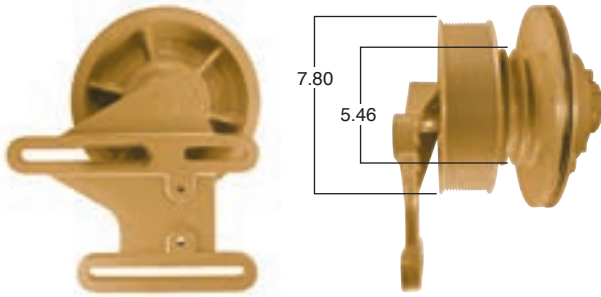

FLT91089

Fleetrite
Part Number

Rebuild with kit #
FLT9500HP

9.5" Friction Plate

2" Fan Pilot

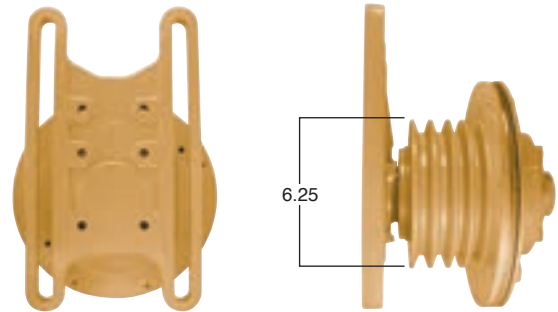

FLT91090

Fleetrite
Part Number

Rebuild with kit #
FLT9500HP

9.5" Friction Plate

2" Fan Pilot

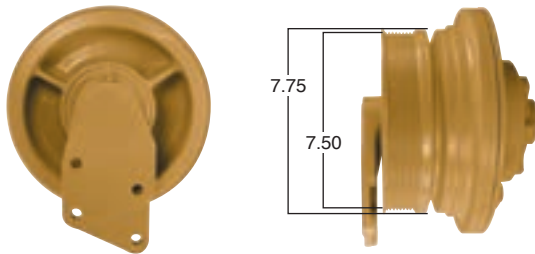

FLT91097

Fleetrite
Part Number

Rebuild with kit #
FLT9500HP

9.5" Friction Plate

2" Fan Pilot
Same as FLT91007

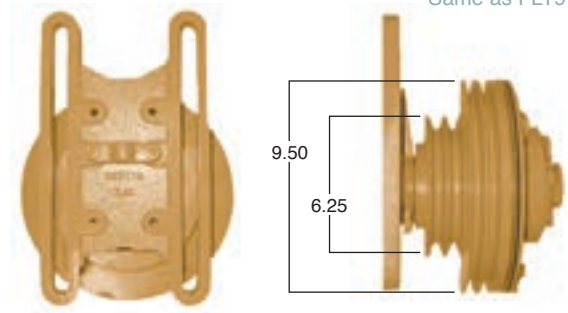

FLT91098

Fleetrite
Part Number

Rebuild with kit #
FLT9500HP

9.5" Friction Plate

5" Fan Pilot

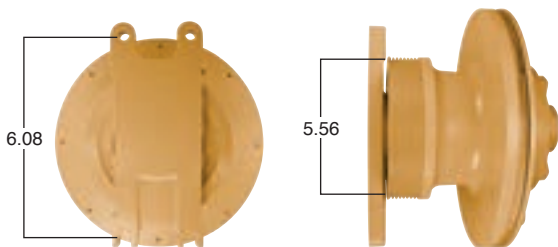

FLT91102

Fleetrite
Part Number

Rebuild with kit #
FLT9500HP

9.5" Friction Plate

2.56" Fan Pilot

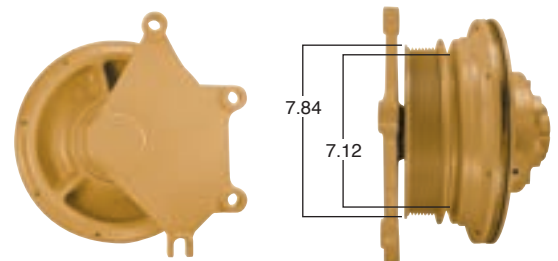

FLT91106

Fleetrite
Part Number

Rebuild with kit #
FLT9500HP

9.5" Friction Plate

2" Fan Pilot

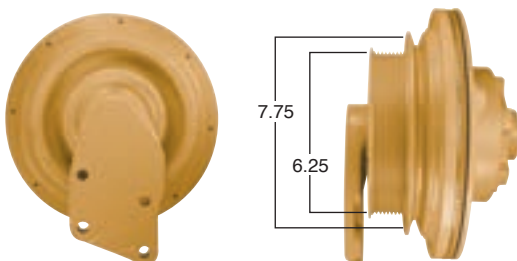

FLT91115

Fleetrite
Part Number

Rebuild with kit #
FLT9505SP

9.5" Friction Plate

Variation requires kit # FLT9500HP
5" Fan Pilot

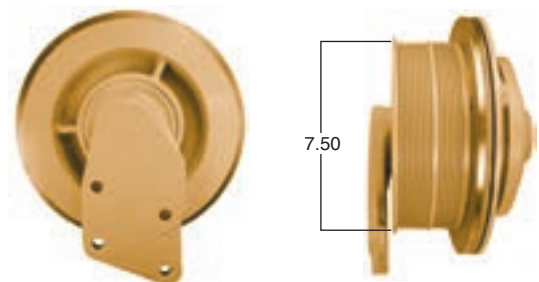

FLT91116

Fleetrite Part Number

Rebuild with kit #
FLT9500HP

9.5" Friction Plate

2" Fan Pilot

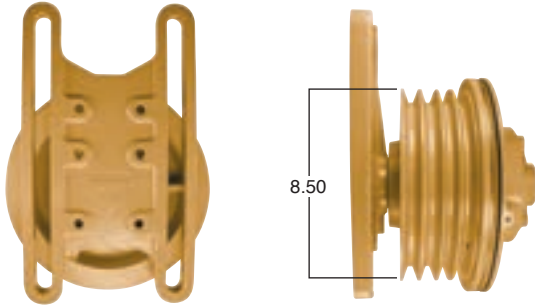

FLT98614

Fleetrite Part Number

Rebuild with kit #
FLT14256

Or Convert to
2-Speed Version

FLT986142

Rebuild/convert with kit #
FLT24256

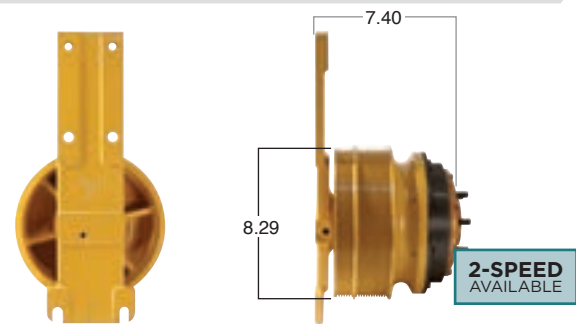

FLT98641

Fleetrite Part Number

Rebuild with kit #
FLT14256

Or Convert to
2-Speed Version

FLT986412

Rebuild/convert with kit #
FLT24256

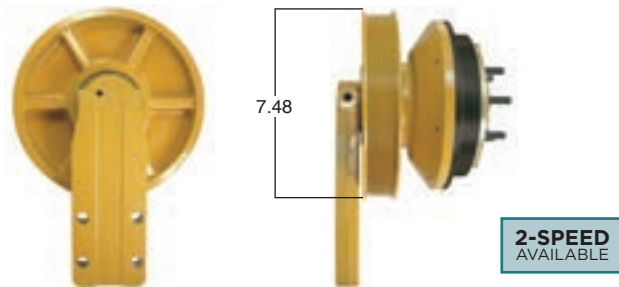

FLT98645

Fleetrite Part Number

Rebuild with kit #
FLT142561

Or Convert to
2-Speed Version

FLT986452

Rebuild/convert with kit #
FLT242561

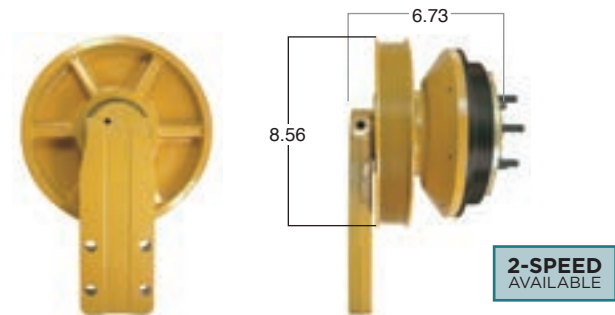

FLT98647

Fleetrite Part Number

Rebuild with kit #
FLT14256

Or Convert to
2-Speed Version

FLT986472

Rebuild/convert with kit #
FLT24256

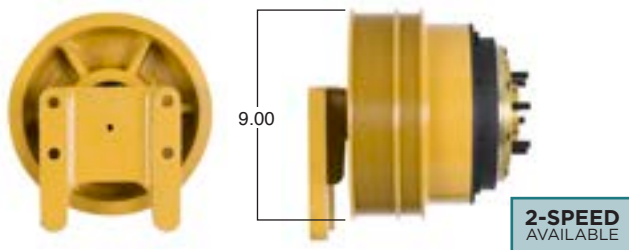

FLT99008

Fleetrite Part Number

Rebuild with kit #
FLT142561

Or Convert to
2-Speed Version

FLT990082

Rebuild/convert with kit #
FLT242561

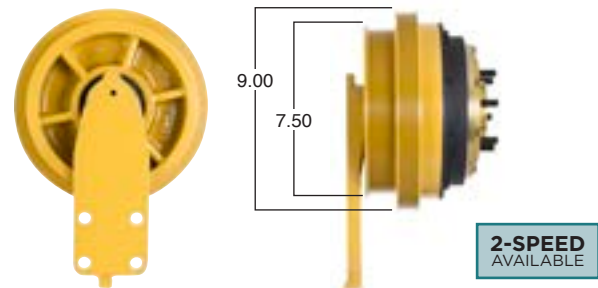

FLT99009

Fleetrite Part Number

Rebuild with kit #
FLT142561

Or Convert to
2-Speed Version

FLT990092

Rebuild/convert with kit #
FLT242561

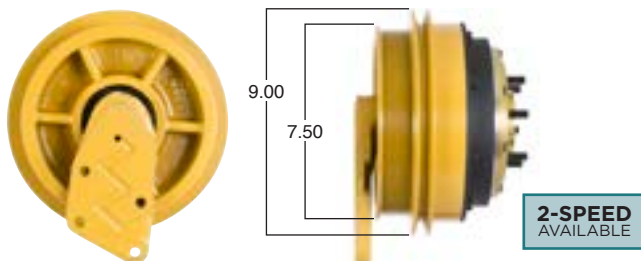

FLT99012

Fleetrite Part Number

Rebuild with kit #
FLT14256

Or Convert to
2-Speed Version

FLT990122

Rebuild/convert with kit #
FLT24256

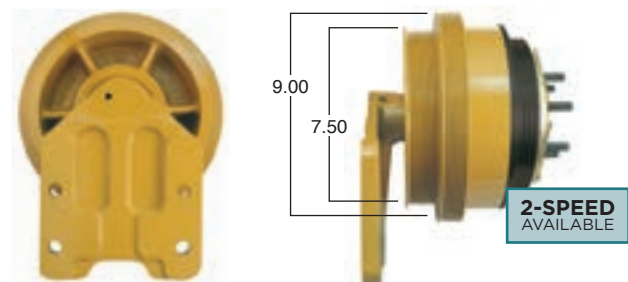

FLT99034 Fleetrite Part Number
 Rebuild with kit # **FLT14256**
 Or Convert to 2-Speed Version ▶ **FLT990342** Rebuild/convert with kit # **FLT24256**

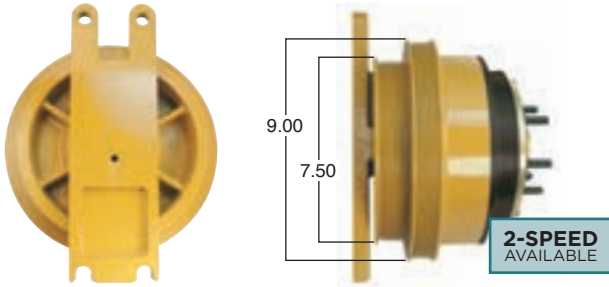

FLT99037 Fleetrite Part Number
 Rebuild with kit # **FLT14256**
 Or Convert to 2-Speed Version ▶ **FLT990372** Rebuild/convert with kit # **FLT24256**

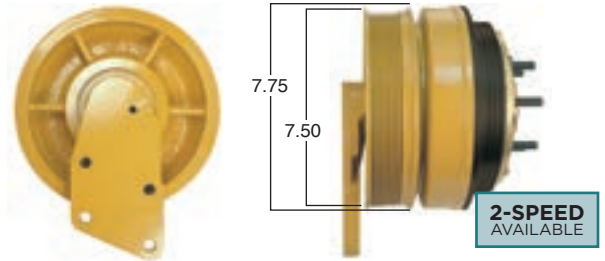

FLT99038 Fleetrite Part Number
 Rebuild with kit # **FLT14256**
 Or Convert to 2-Speed Version ▶ **FLT990382** Rebuild/convert with kit # **FLT24256**

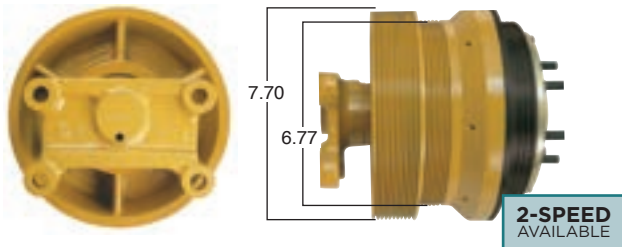

FLT99044 Fleetrite Part Number
 Rebuild with kit # **FLT14256**
 Or Convert to 2-Speed Version ▶ **FLT990442** Rebuild/convert with kit # **FLT24256**

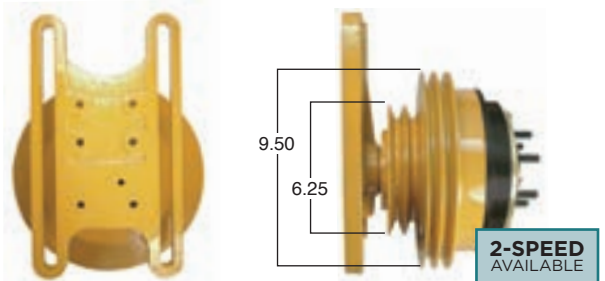

FLT99046 Fleetrite Part Number
 Rebuild with kit # **FLT14256**
 Or Convert to 2-Speed Version ▶ **FLT990462** Rebuild/convert with kit # **FLT24256**

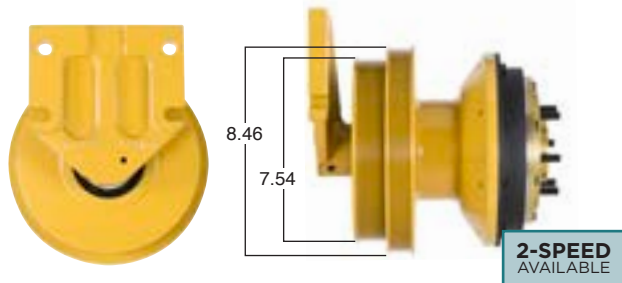

FLT99068 Fleetrite Part Number
 Rebuild with kit # **FLT14256**
 Or Convert to 2-Speed Version ▶ **FLT990682** Rebuild/convert with kit # **FLT24256**

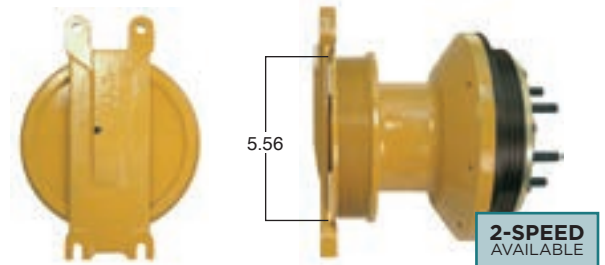

FLT99069 Fleetrite Part Number
 Rebuild with kit # **FLT14256**
 Or Convert to 2-Speed Version ▶ **FLT990692** Rebuild/convert with kit # **FLT24256**

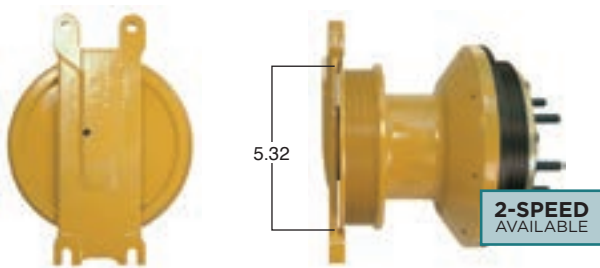

FLT99070 Fleetrite Part Number
 Rebuild with kit # **FLT14256**
 Or Convert to 2-Speed Version ▶ **FLT990702** Rebuild/convert with kit # **FLT24256**

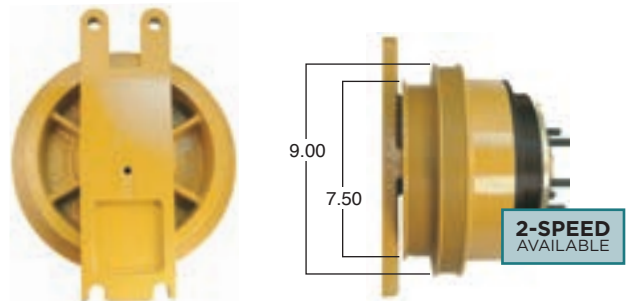

FLT99072 Fleetrite Part Number Rebuild with kit # FLT14256
 Or Convert to 2-Speed Version ▶ **FLT990722** Rebuild/convert with kit # FLT24256

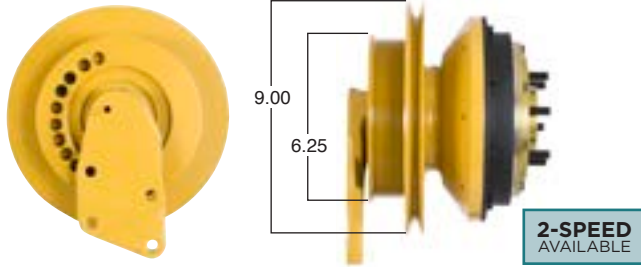

FLT99073 Fleetrite Part Number Rebuild with kit # FLT14256
 Or Convert to 2-Speed Version ▶ **FLT990732** Rebuild/convert with kit # FLT24256

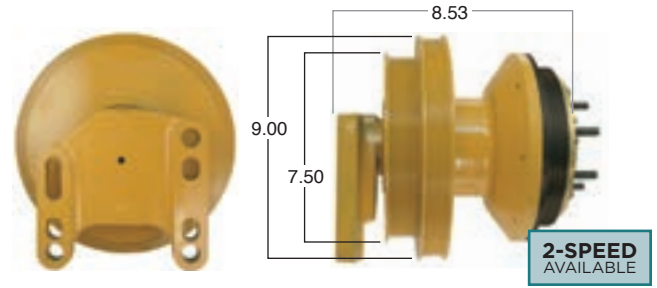

FLT99074 Fleetrite Part Number Rebuild with kit # FLT14256
 Or Convert to 2-Speed Version ▶ **FLT990742** Rebuild/convert with kit # FLT24256

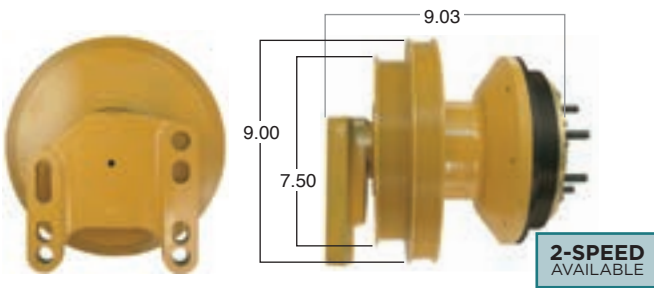

FLT99075 Fleetrite Part Number Rebuild with kit # FLT14256
 Or Convert to 2-Speed Version ▶ **FLT990752** Rebuild/convert with kit # FLT24256

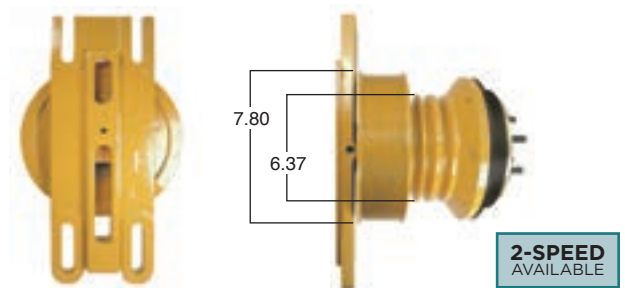

FLT99076 Fleetrite Part Number Rebuild with kit # FLT14256
 Or Convert to 2-Speed Version ▶ **FLT990762** Rebuild/convert with kit # FLT24256

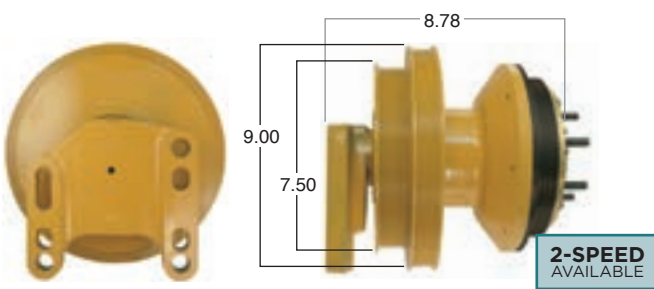

FLT99078 Fleetrite Part Number Rebuild with kit # FLT14256
 Or Convert to 2-Speed Version ▶ **FLT990782** Rebuild/convert with kit # FLT24256

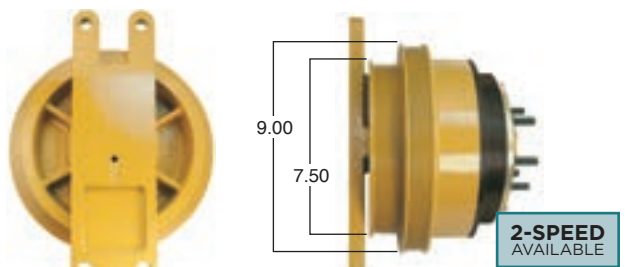

FLT99079 Fleetrite Part Number Rebuild with kit # FLT14256
 Or Convert to 2-Speed Version ▶ **FLT990792** Rebuild/convert with kit # FLT24256

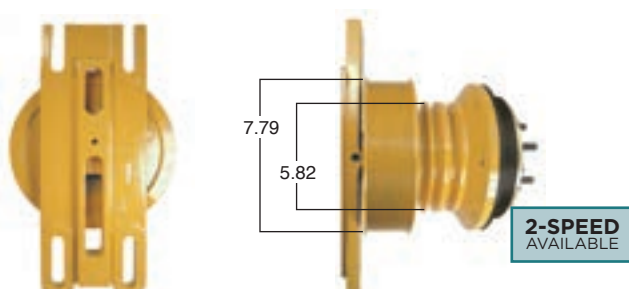

FLT99080 Fleetrite Part Number Rebuild with kit # FLT14256
 Or Convert to 2-Speed Version ▶ **FLT990802** Rebuild/convert with kit # FLT24256

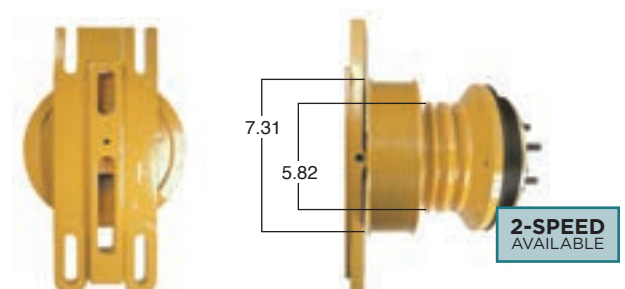

FLT99084 Fleetrite Part Number Rebuild with kit # FLT14256

Or Convert to 2-Speed Version **FLT990842** Rebuild/convert with kit # FLT24256

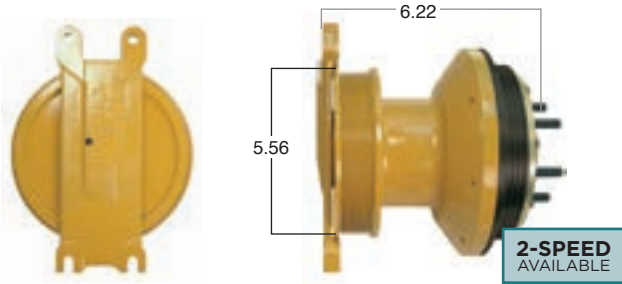

FLT99098 Fleetrite Part Number Rebuild with kit # FLT14256

Or Convert to 2-Speed Version **FLT990982** Rebuild/convert with kit # FLT24256

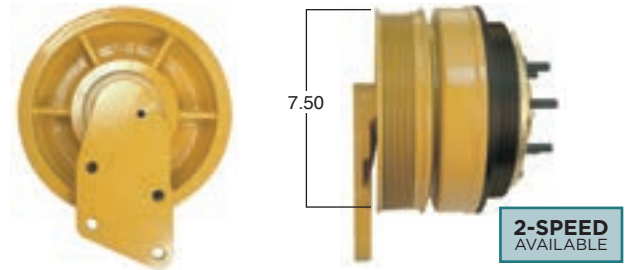

FLT99103 Fleetrite Part Number Rebuild with kit # FLT14256

Or Convert to 2-Speed Version **FLT991032** Rebuild/convert with kit # FLT24256

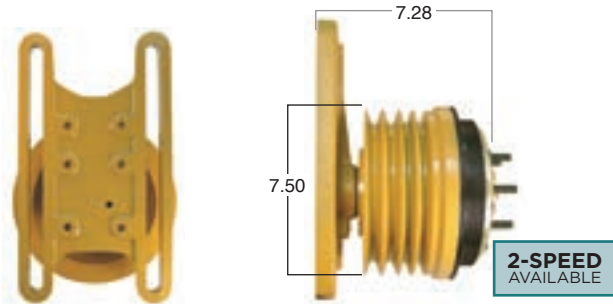

FLT99119 Fleetrite Part Number Rebuild with kit # FLT14256

Or Convert to 2-Speed Version **FLT991192** Rebuild/convert with kit # FLT24256

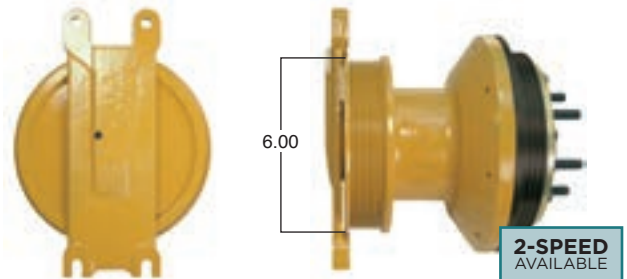

FLT99135 Fleetrite Part Number Rebuild with kit # FLT14256

Or Convert to 2-Speed Version **FLT991352** Rebuild/convert with kit # FLT24256

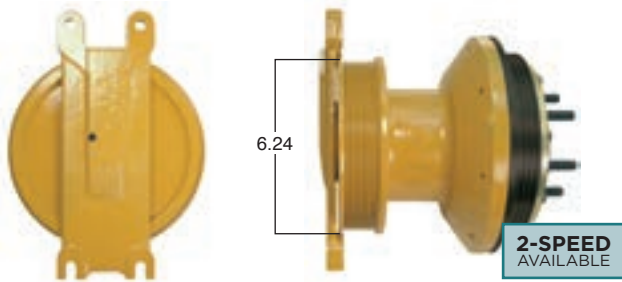

FLT99139 Fleetrite Part Number Rebuild with kit # FLT14256

Or Convert to 2-Speed Version **FLT991392** Rebuild/convert with kit # FLT24256

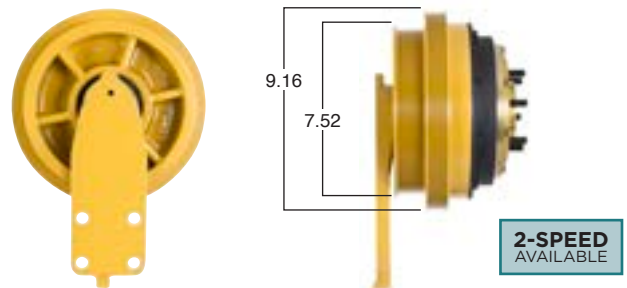

FLT99155 Fleetrite Part Number Rebuild with kit # FLT14256

Or Convert to 2-Speed Version **FLT991552** Rebuild/convert with kit # FLT24256

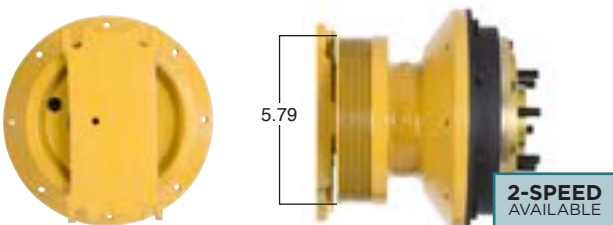

FLT99157 Fleetrite Part Number Rebuild with kit # FLT14256

Or Convert to 2-Speed Version **FLT991572** Rebuild/convert with kit # FLT24256

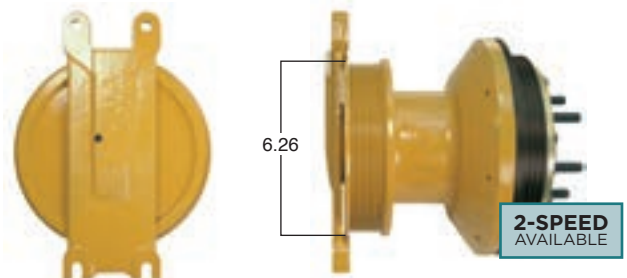

FLT99160

Fleetrite Part Number

Rebuild with kit # FLT14256

Or Convert to 2-Speed Version

FLT991602

Rebuild/convert with kit # FLT24256

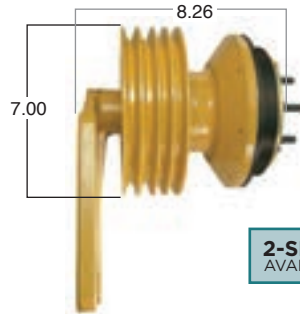

2-SPEED AVAILABLE

FLT99161

Fleetrite Part Number

Rebuild with kit # FLT14256

Or Convert to 2-Speed Version

FLT991612

Rebuild/convert with kit # FLT24256

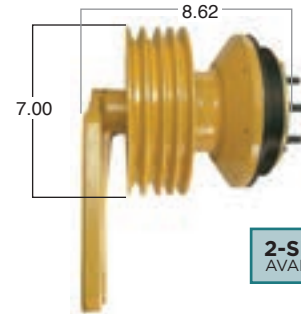

2-SPEED AVAILABLE

FLT99162

Fleetrite Part Number

Rebuild with kit # FLT14256

Or Convert to 2-Speed Version

FLT991622

Rebuild/convert with kit # FLT24256

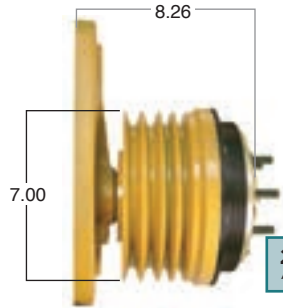

2-SPEED AVAILABLE

FLT99163

Fleetrite Part Number

Rebuild with kit # FLT14256

Or Convert to 2-Speed Version

FLT991632

Rebuild/convert with kit # FLT24256

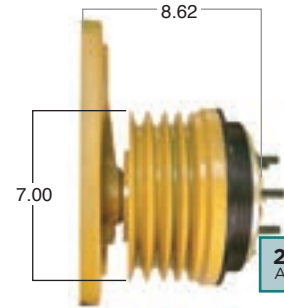

2-SPEED AVAILABLE

FLT99164

Fleetrite Part Number

Rebuild with kit # FLT14256

Or Convert to 2-Speed Version

FLT991642

Rebuild/convert with kit # FLT24256

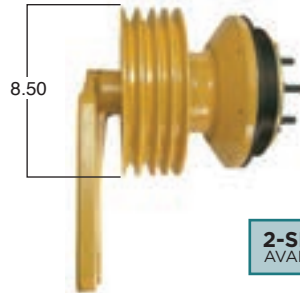

2-SPEED AVAILABLE

FLT99173

Fleetrite Part Number

Rebuild with kit # FLT14256

Or Convert to 2-Speed Version

FLT991732

Rebuild/convert with kit # FLT24256

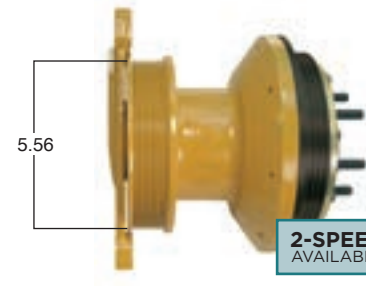

2-SPEED AVAILABLE

FLT99177

Fleetrite Part Number

Rebuild with kit # FLT14256

Or Convert to 2-Speed Version

FLT991772

Rebuild/convert with kit # FLT24256

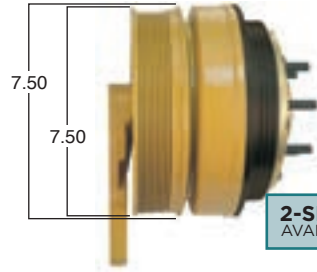

2-SPEED AVAILABLE

FLT99189

Fleetrite Part Number

Rebuild with kit # FLT14256

Or Convert to 2-Speed Version

FLT991892

Rebuild/convert with kit # FLT24256

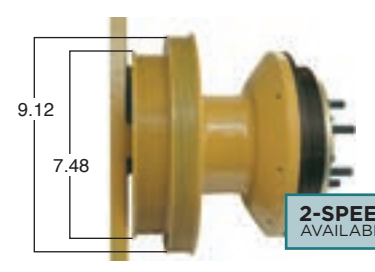

2-SPEED AVAILABLE

FLT99190 Fleetrite Part Number Rebuild with kit # **FLT14256**

Or Convert to 2-Speed Version ▶ **FLT991902** Rebuild/convert with kit # **FLT24256**

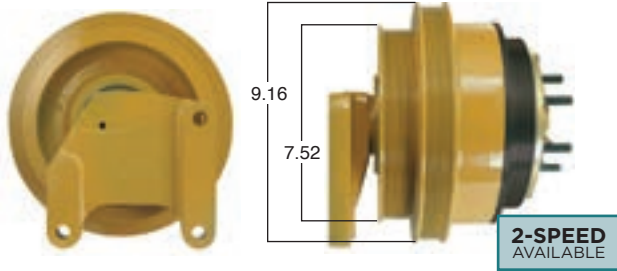

FLT99191 Fleetrite Part Number Rebuild with kit # **FLT14256**

Or Convert to 2-Speed Version ▶ **FLT991912** Rebuild/convert with kit # **FLT24256**

Also use Stud Kit 300SK

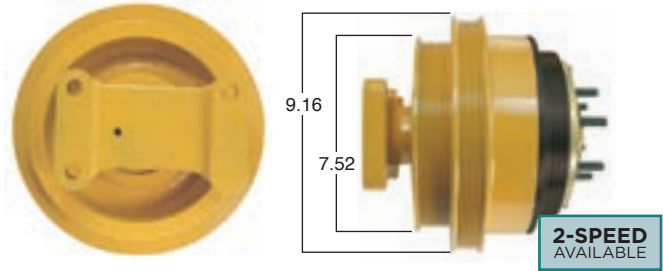

FLT99194 Fleetrite Part Number Rebuild with kit # **FLT14256**

Or Convert to 2-Speed Version ▶ **FLT991942** Rebuild/convert with kit # **FLT24256**

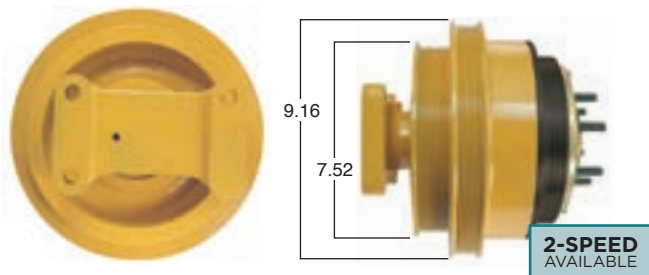

FLT99199 Fleetrite Part Number Rebuild with kit # **FLT14256**

Or Convert to 2-Speed Version ▶ **FLT991992** Rebuild/convert with kit # **FLT24256**

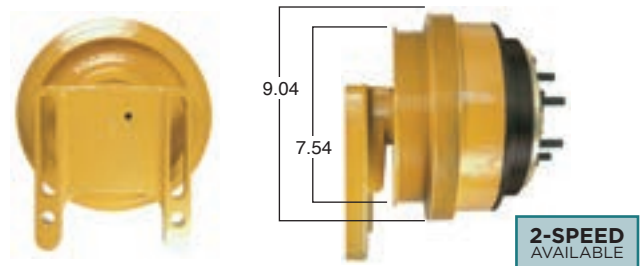

FLT99200 Fleetrite Part Number Rebuild with kit # **FLT14256**

Or Convert to 2-Speed Version ▶ **FLT992002** Rebuild/convert with kit # **FLT24256**

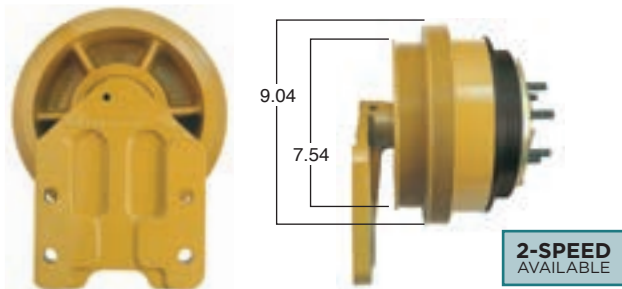

FLT99208 Fleetrite Part Number Rebuild with kit # **FLT14256**

Or Convert to 2-Speed Version ▶ **FLT992082** Rebuild/convert with kit # **FLT24256**

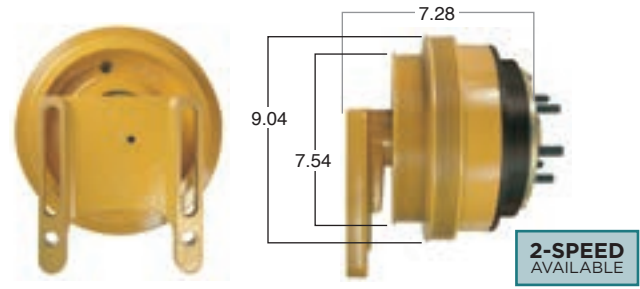

FLT99209 Fleetrite Part Number Rebuild with kit # **FLT14256**

Or Convert to 2-Speed Version ▶ **FLT992092** Rebuild/convert with kit # **FLT24256**

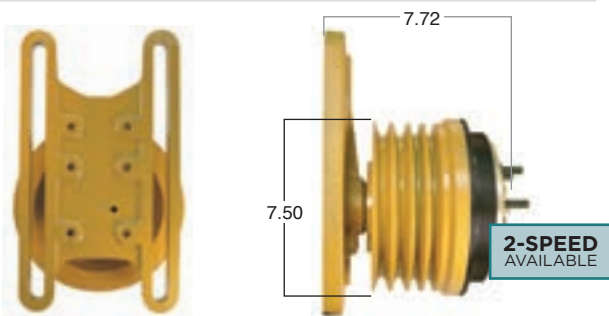

FLT99211 Fleetrite Part Number Rebuild with kit # **FLT14256**

Or Convert to 2-Speed Version ▶ **FLT992112** Rebuild/convert with kit # **FLT24256**

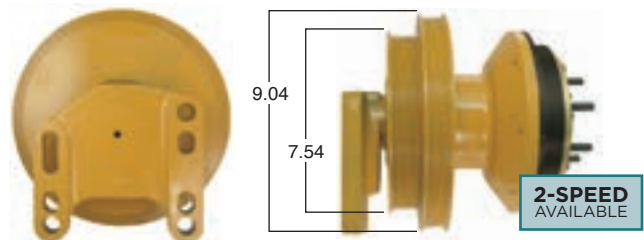

FLT99212 Fleetrite Part Number Rebuild with kit # FLT14256
 Or Convert to 2-Speed Version ▶ **FLT992122** Rebuild/convert with kit # FLT24256

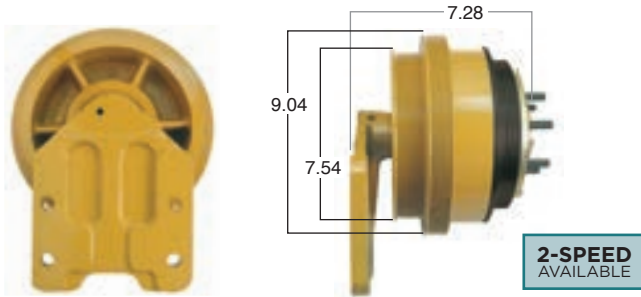

FLT99220 Fleetrite Part Number Rebuild with kit # FLT14256
 Or Convert to 2-Speed Version ▶ **FLT992202** Rebuild/convert with kit # FLT24256

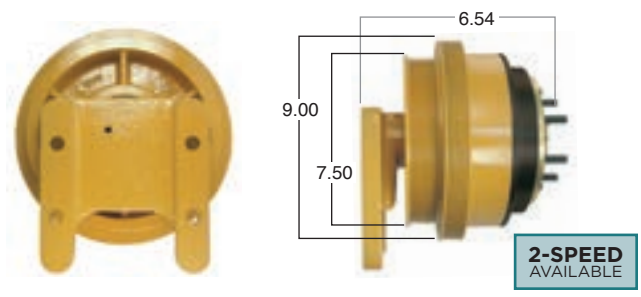

FLT99221 Fleetrite Part Number Rebuild with kit # FLT14256
 Or Convert to 2-Speed Version ▶ **FLT992212** Rebuild/convert with kit # FLT24256

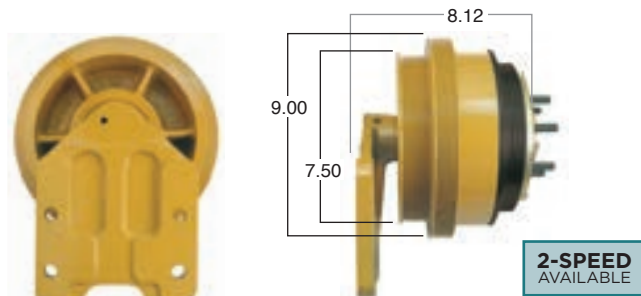

FLT99240 Fleetrite Part Number Rebuild with kit # FLT14256
 Or Convert to 2-Speed Version ▶ **FLT992402** Rebuild/convert with kit # FLT24256

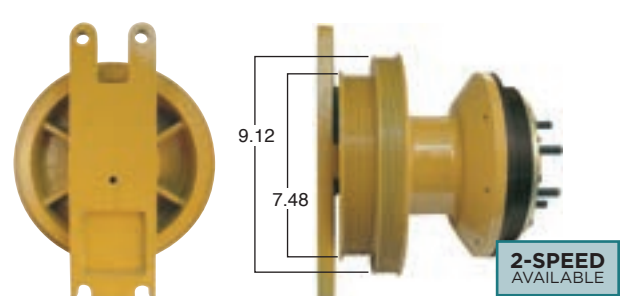

FLT99241 Fleetrite Part Number Rebuild with kit # FLT14256
 Or Convert to 2-Speed Version ▶ **FLT992412** Rebuild/convert with kit # FLT24256

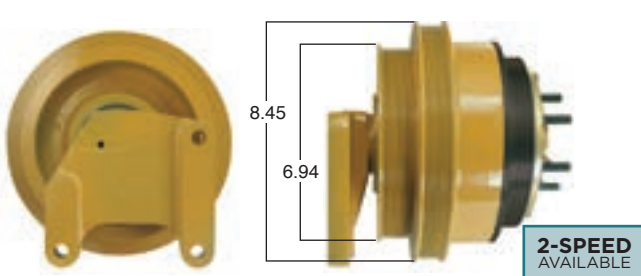

FLT99269 Fleetrite Part Number Rebuild with kit # FLT14256
 Or Convert to 2-Speed Version ▶ **FLT992692** Rebuild/convert with kit # FLT24256

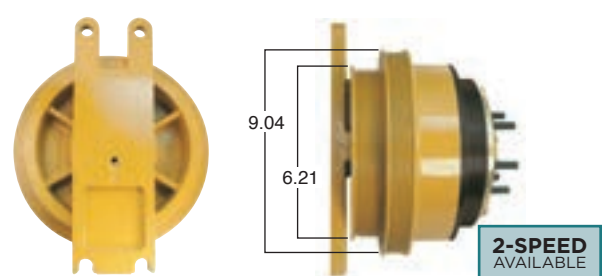

FLT99273 Fleetrite Part Number Rebuild with kit # FLT14256
 Or Convert to 2-Speed Version ▶ **FLT992732** Rebuild/convert with kit # FLT24256

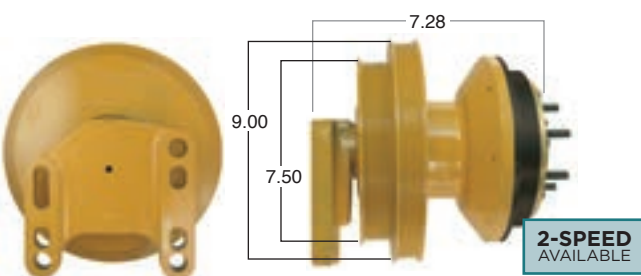

FLT99279 Fleetrite Part Number Rebuild with kit # FLT14256
 Or Convert to 2-Speed Version ▶ **FLT992792** Rebuild/convert with kit # FLT24256

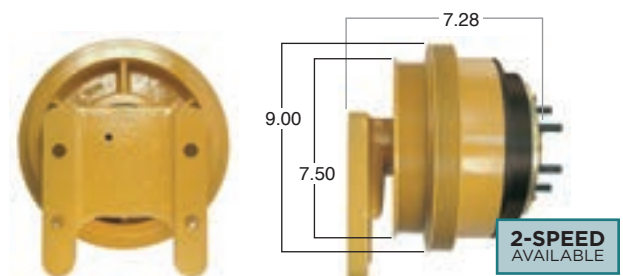

FLT99289 Fleetrite Part Number Rebuild with kit # FLT14256

Or Convert to 2-Speed Version **FLT992892** Rebuild/convert with kit # FLT24256

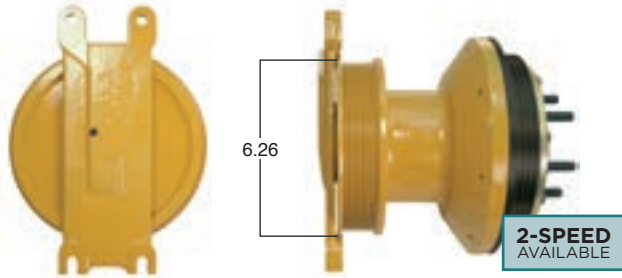

FLT99291 Fleetrite Part Number Rebuild with kit # FLT14256

Or Convert to 2-Speed Version **FLT992912** Rebuild/convert with kit # FLT24256

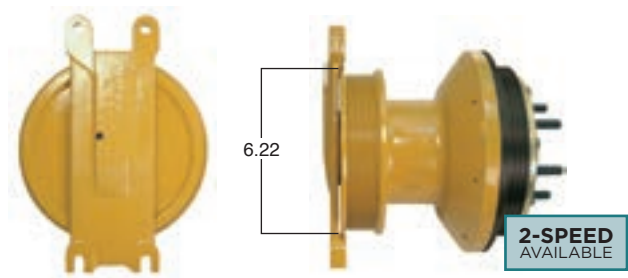

FLT99292 Fleetrite Part Number Rebuild with kit # FLT14256

Or Convert to 2-Speed Version **FLT992922** Rebuild/convert with kit # FLT24256

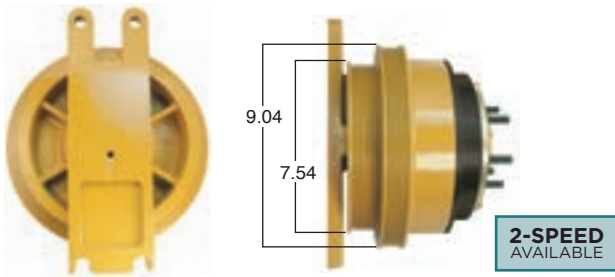

FLT99293 Fleetrite Part Number Rebuild with kit # FLT14256

Or Convert to 2-Speed Version **FLT992932** Rebuild/convert with kit # FLT24256

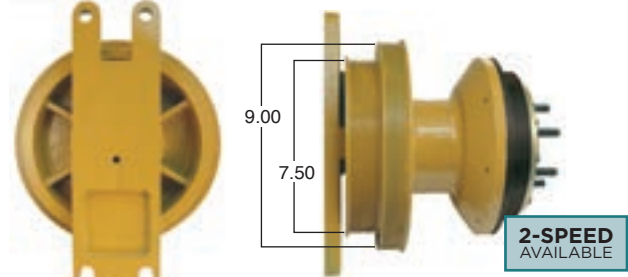

FLT99294 Fleetrite Part Number Rebuild with kit # FLT14256

Or Convert to 2-Speed Version **FLT992942** Rebuild/convert with kit # FLT24256

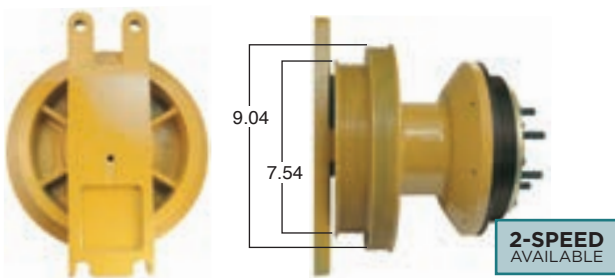

FLT99298 Fleetrite Part Number Rebuild with kit # FLT14256

Or Convert to 2-Speed Version **FLT992982** Rebuild/convert with kit # FLT24256

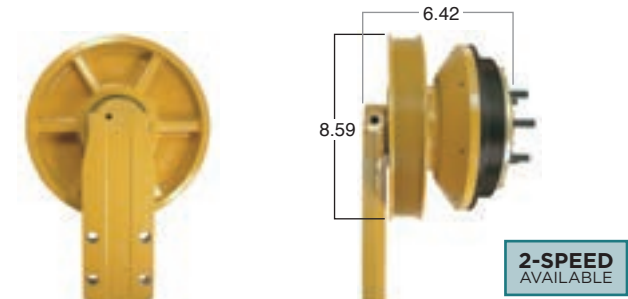

FLT99307 Fleetrite Part Number Rebuild with kit # FLT14256

Or Convert to 2-Speed Version **FLT993072** Rebuild/convert with kit # FLT24256

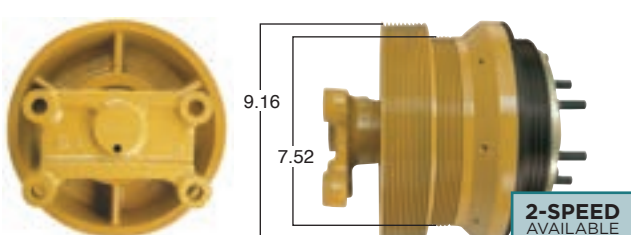

FLT99311 Fleetrite Part Number Rebuild with kit # FLT142561

Or Convert to 2-Speed Version **FLT993112** Rebuild/convert with kit # FLT242561

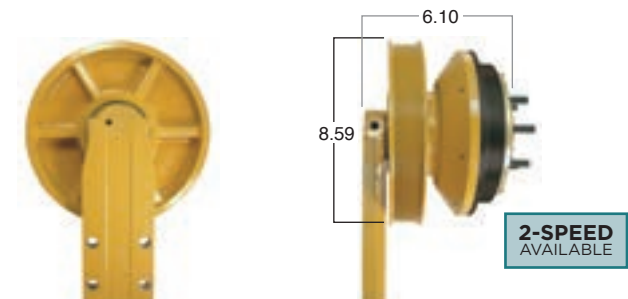

FLT99313

Fleetrite
Part Number

Rebuild with kit #
FLT14256

Or Convert to
2-Speed Version

▶ **FLT993132**

Rebuild/convert with kit #
FLT24256

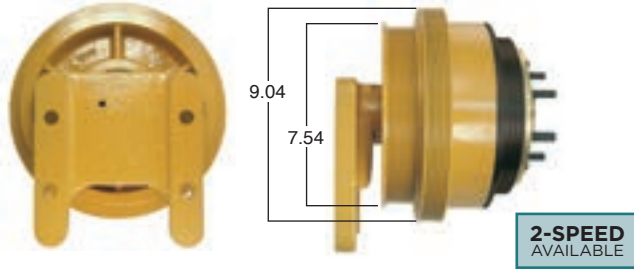

FLT99316

Fleetrite
Part Number

Rebuild with kit #
FLT14256

Or Convert to
2-Speed Version

▶ **FLT993162**

Rebuild/convert with kit #
FLT24256

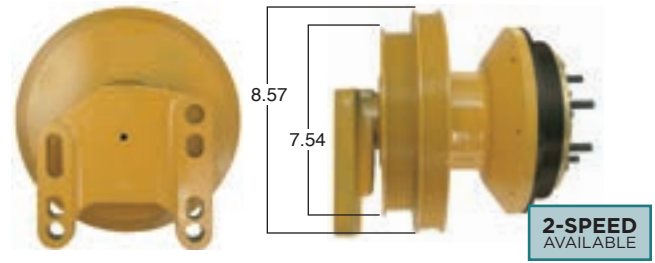

FLT99317

Fleetrite
Part Number

Rebuild with kit #
FLT14256

Or Convert to
2-Speed Version

▶ **FLT993172**

Rebuild/convert with kit #
FLT24256

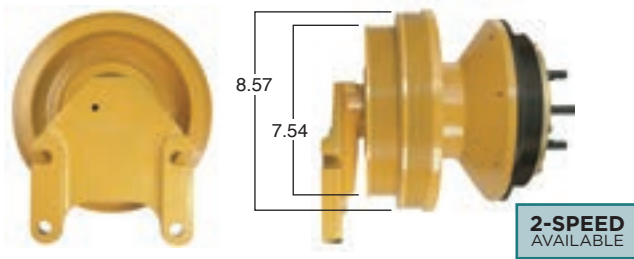

FLT99318

Fleetrite
Part Number

Rebuild with kit #
FLT14256

Or Convert to
2-Speed Version

▶ **FLT993182**

Rebuild/convert with kit #
FLT24256

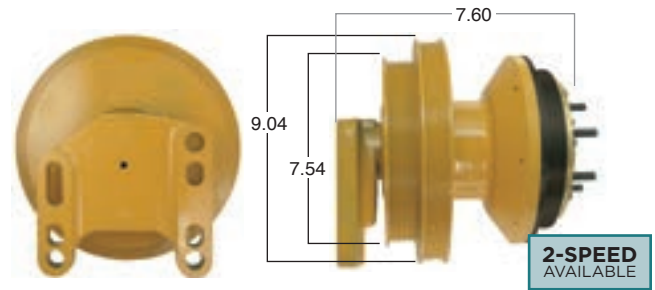

FLT99319

Fleetrite
Part Number

Rebuild with kit #
FLT14256

Or Convert to
2-Speed Version

▶ **FLT993192**

Rebuild/convert with kit #
FLT24256

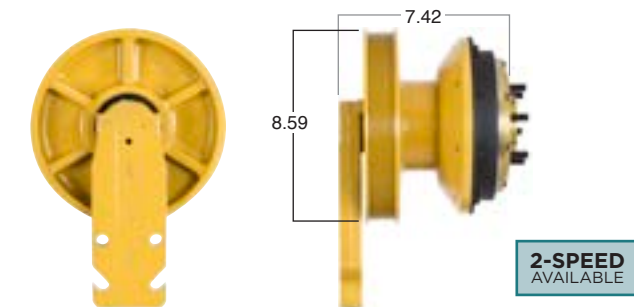

FLT99322

Fleetrite
Part Number

Rebuild with kit #
FLT14256

Or Convert to
2-Speed Version

▶ **FLT993222**

Rebuild/convert with kit #
FLT24256

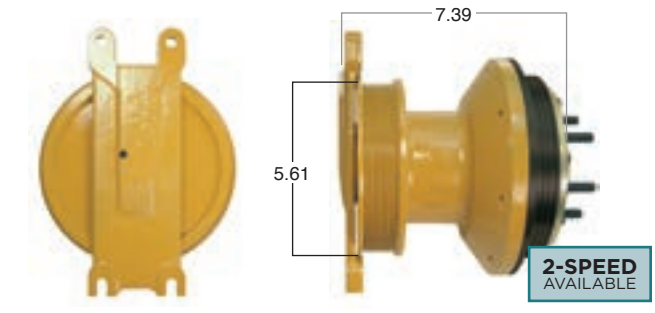

FLT99327

Fleetrite
Part Number

Rebuild with kit #
FLT14256

Or Convert to
2-Speed Version

▶ **FLT993272**

Rebuild/convert with kit #
FLT24256

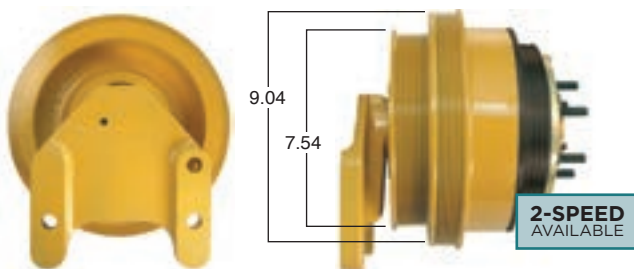

FLT99330

Fleetrite
Part Number

Rebuild with kit #
FLT14256

Or Convert to
2-Speed Version

▶ **FLT993302**

Rebuild/convert with kit #
FLT24256

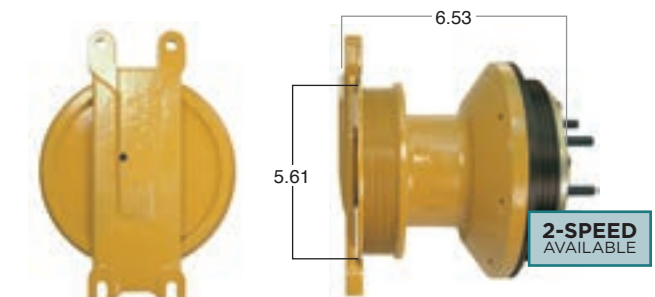

FLT99333 Fleetrite Part Number Rebuild with kit # FLT14256

Or Convert to 2-Speed Version ▶ **FLT993332** Rebuild/convert with kit # FLT24256

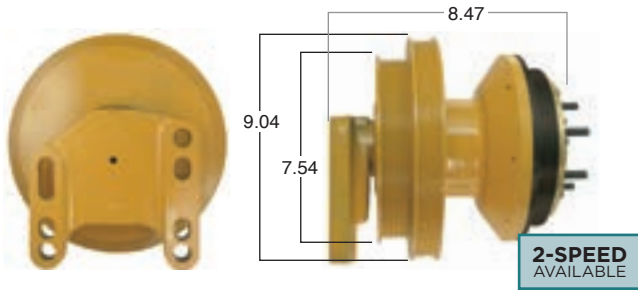

FLT99334 Fleetrite Part Number Rebuild with kit # FLT14256

Or Convert to 2-Speed Version ▶ **FLT993342** Rebuild/convert with kit # FLT24256

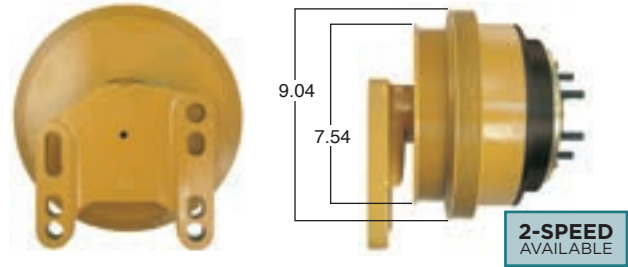

FLT99337 Fleetrite Part Number Rebuild with kit # FLT14256

Or Convert to 2-Speed Version ▶ **FLT993372** Rebuild/convert with kit # FLT24256

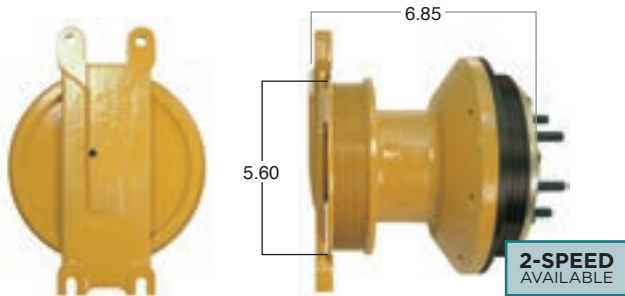

FLT99339 Fleetrite Part Number Rebuild with kit # FLT14256

Or Convert to 2-Speed Version ▶ **FLT993392** Rebuild/convert with kit # FLT24256

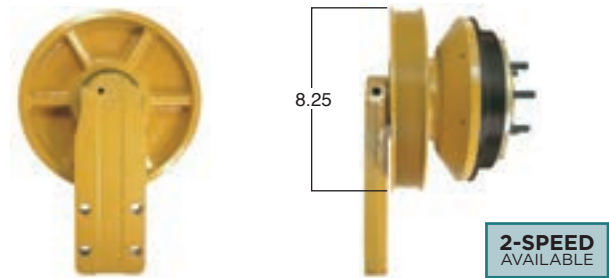

FLT99341 Fleetrite Part Number Rebuild with kit # FLT14256

Or Convert to 2-Speed Version ▶ **FLT993412** Rebuild/convert with kit # FLT24256

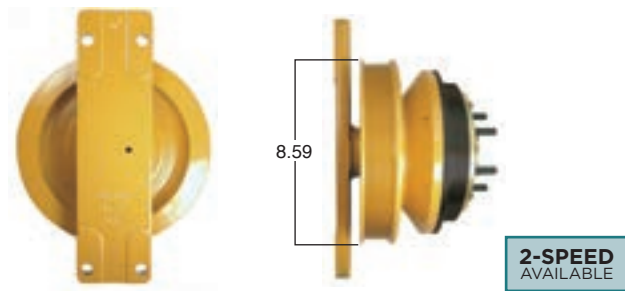

FLT99346 Fleetrite Part Number Rebuild with kit # FLT14256

Or Convert to 2-Speed Version ▶ **FLT993462** Rebuild/convert with kit # FLT24256

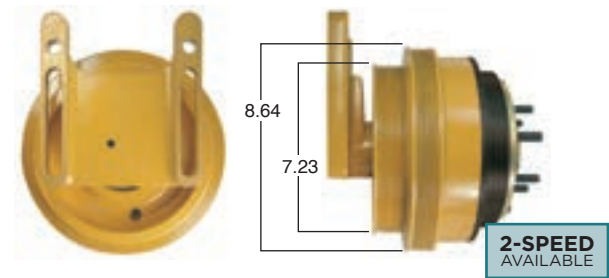

FLT99351 Fleetrite Part Number Rebuild with kit # FLT14256

Or Convert to 2-Speed Version ▶ **FLT993512** Rebuild/convert with kit # FLT24256

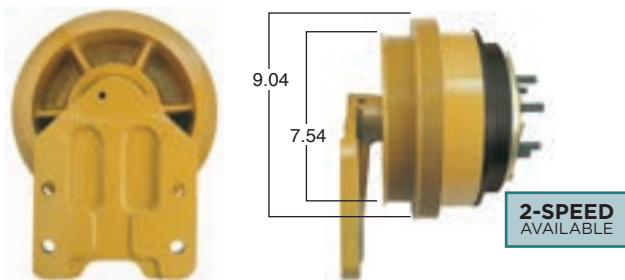

FLT99353 Fleetrite Part Number Rebuild with kit # FLT14256

Or Convert to 2-Speed Version ▶ **FLT993532** Rebuild/convert with kit # FLT24256

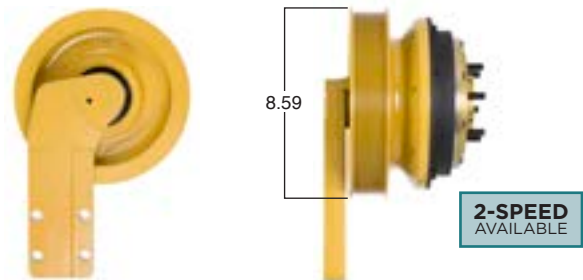

FLT99354 Fleetrite Part Number Rebuild with kit # FLT14256
 Or Convert to 2-Speed Version ▶ **FLT993542** Rebuild/convert with kit # FLT24256

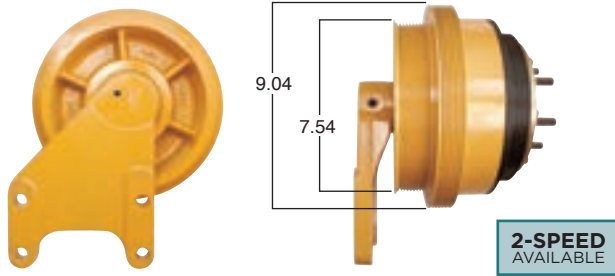

FLT99358 Fleetrite Part Number Rebuild with kit # FLT14256
 Or Convert to 2-Speed Version ▶ **FLT993582** Rebuild/convert with kit # FLT24256

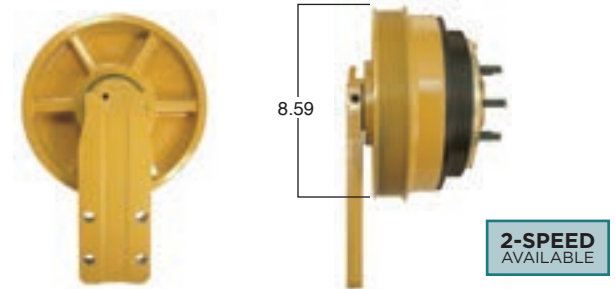

FLT99359 Fleetrite Part Number Rebuild with kit # FLT14256
 Or Convert to 2-Speed Version ▶ **FLT993592** Rebuild/convert with kit # FLT24256

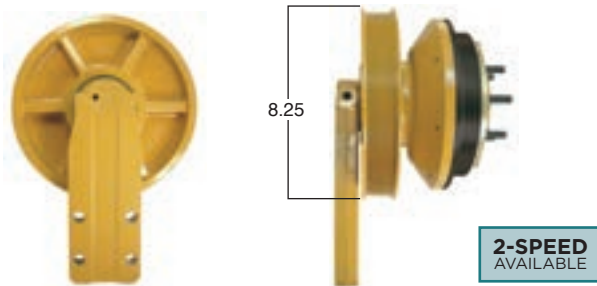

FLT99360 Fleetrite Part Number Rebuild with kit # FLT14256
 Or Convert to 2-Speed Version ▶ **FLT993602** Rebuild/convert with kit # FLT24256

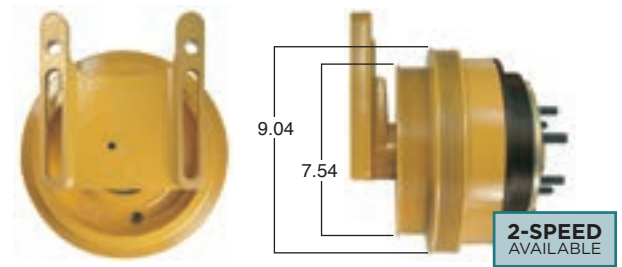

FLT99361 Fleetrite Part Number Rebuild with kit # FLT14256
 Or Convert to 2-Speed Version ▶ **FLT993612** Rebuild/convert with kit # FLT24256

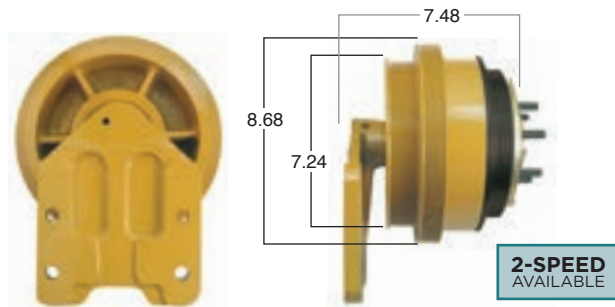

FLT99362 Fleetrite Part Number Rebuild with kit # FLT14256
 Or Convert to 2-Speed Version ▶ **FLT993622** Rebuild/convert with kit # FLT24256

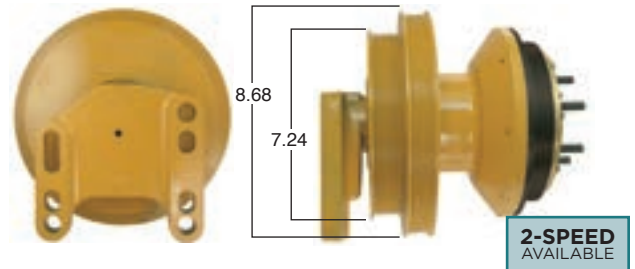

FLT99363 Fleetrite Part Number Rebuild with kit # FLT14256
 Or Convert to 2-Speed Version ▶ **FLT993632** Rebuild/convert with kit # FLT24256

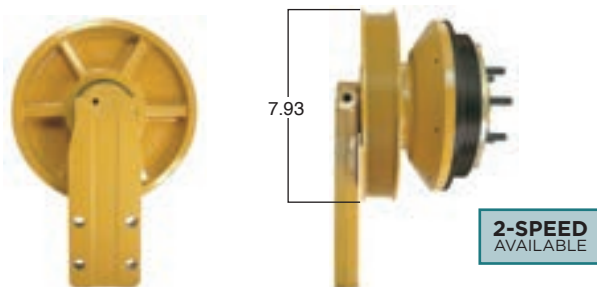

FLT99366 Fleetrite Part Number Rebuild with kit # FLT14256
 Or Convert to 2-Speed Version ▶ **FLT993662** Rebuild/convert with kit # FLT24256

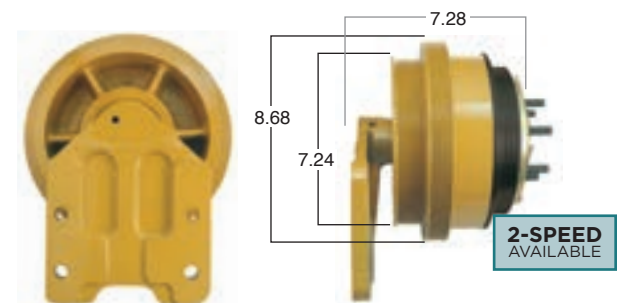

FLT99367 Fleetrite Part Number Rebuild with kit # FLT142561

Or Convert to 2-Speed Version ▶ **FLT993672** Rebuild/convert with kit # FLT242561

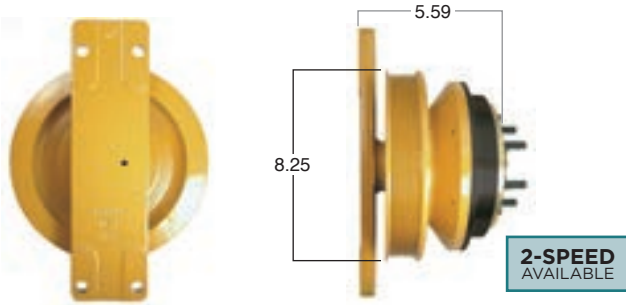

FLT99368 Fleetrite Part Number Rebuild with kit # FLT142561

Or Convert to 2-Speed Version ▶ **FLT993682** Rebuild/convert with kit # FLT242561

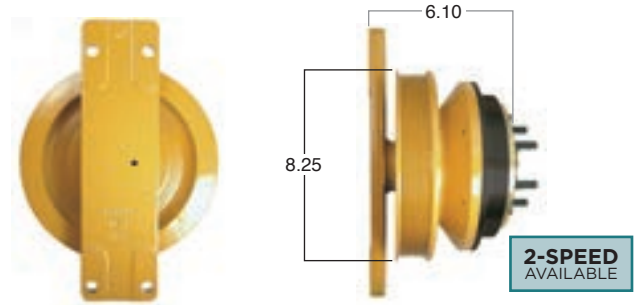

FLT99369 Fleetrite Part Number Rebuild with kit # FLT14256

Or Convert to 2-Speed Version ▶ **FLT993692** Rebuild/convert with kit # FLT24256

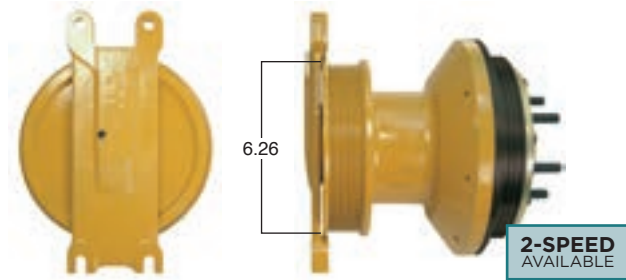

FLT99374 Fleetrite Part Number Rebuild with kit # FLT14256

Or Convert to 2-Speed Version ▶ **FLT993742** Rebuild/convert with kit # FLT24256

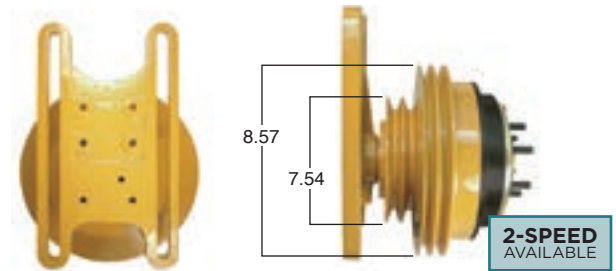

FLT99377 Fleetrite Part Number Rebuild with kit # FLT14256

Or Convert to 2-Speed Version ▶ **FLT993772** Rebuild/convert with kit # FLT24256

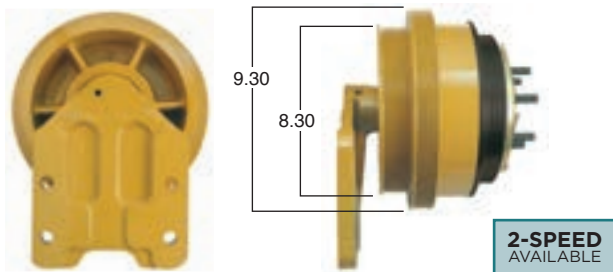

FLT99382 Fleetrite Part Number Rebuild with kit # FLT14256

Or Convert to 2-Speed Version ▶ **FLT993822** Rebuild/convert with kit # FLT24256

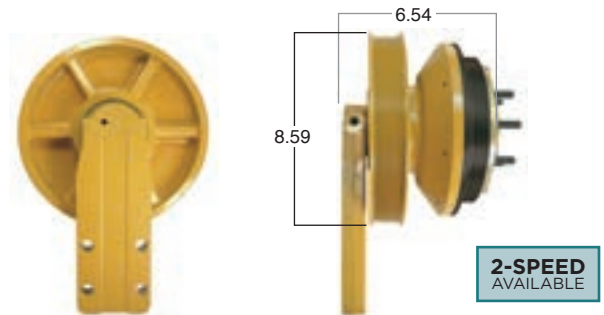

FLT99386 Fleetrite Part Number Rebuild with kit # FLT14256

Or Convert to 2-Speed Version ▶ **FLT993862** Rebuild/convert with kit # FLT24256

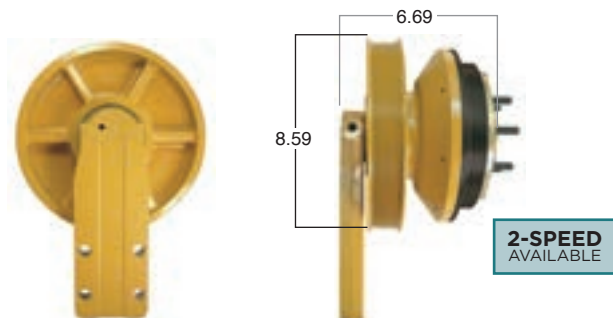

FLT99387 Fleetrite Part Number Rebuild with kit # FLT14256

Or Convert to 2-Speed Version ▶ **FLT993872** Rebuild/convert with kit # FLT24256

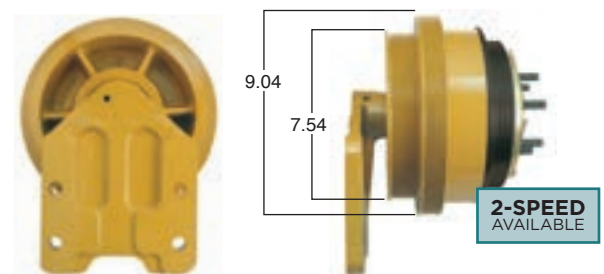

FLT99401

Fleetrite
Part Number

Rebuild with kit #
FLT14256

Or Convert to
2-Speed Version

FLT994012

Rebuild/convert with kit #
FLT24256

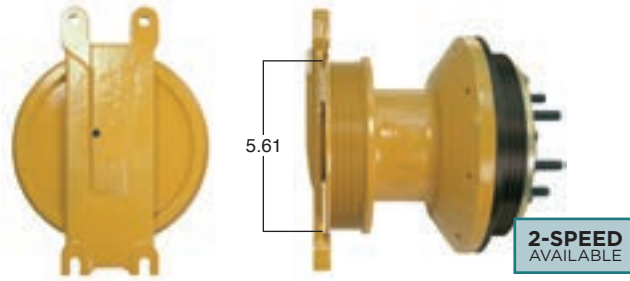

FLT99403

Fleetrite
Part Number

Rebuild with kit #
FLT14256

Or Convert to
2-Speed Version

FLT994032

Rebuild/convert with kit #
FLT24256

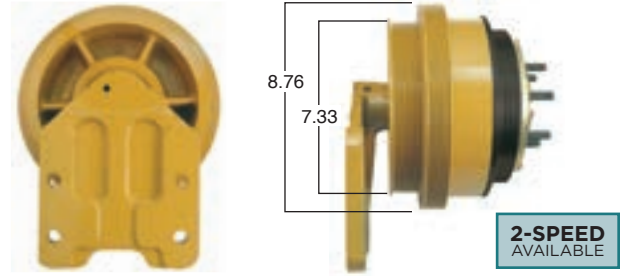

FLT99405

Fleetrite
Part Number

Rebuild with kit #
FLT14256

Or Convert to
2-Speed Version

FLT994052

Rebuild/convert with kit #
FLT24256

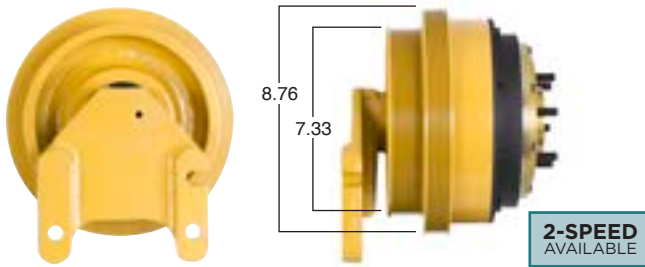

FLT99411

Fleetrite
Part Number

Rebuild with kit #
FLT142561

Or Convert to
2-Speed Version

FLT994112

Rebuild/convert with kit #
FLT242561

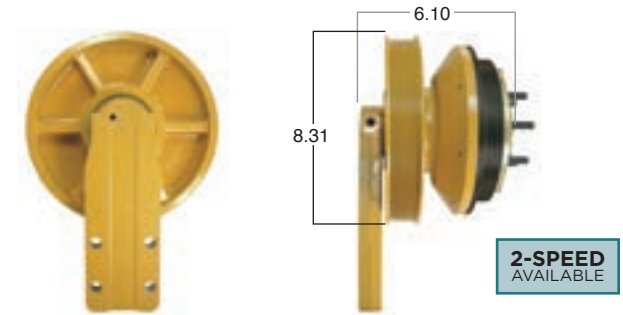

FLT99412

Fleetrite
Part Number

Rebuild with kit #
FLT14256

Or Convert to
2-Speed Version

FLT994122

Rebuild/convert with kit #
FLT24256

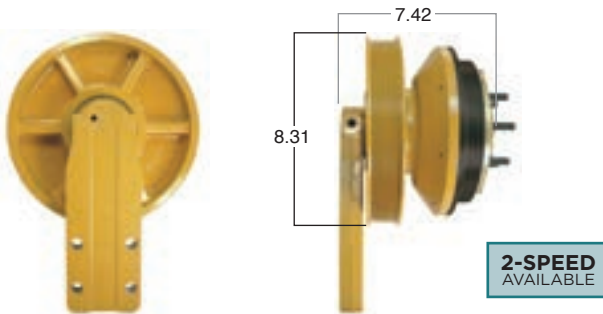

FLT99420

Fleetrite
Part Number

Rebuild with kit #
FLT14256

Or Convert to
2-Speed Version

FLT994202

Rebuild/convert with kit #
FLT24256

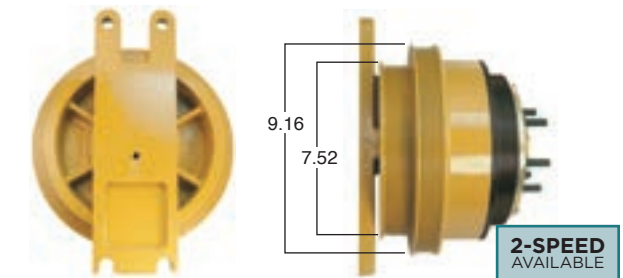

FLT99421

Fleetrite
Part Number

Rebuild with kit #
FLT14256

Or Convert to
2-Speed Version

FLT994212

Rebuild/convert with kit #
FLT24256

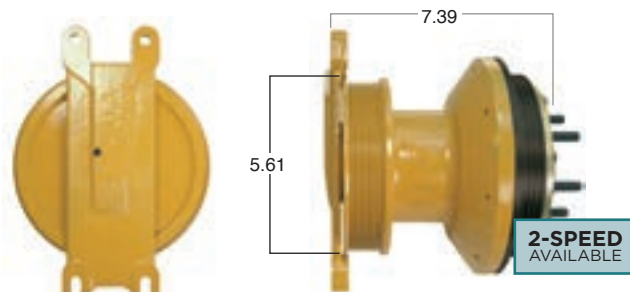

FLT99422

Fleetrite
Part Number

Rebuild with kit #
FLT14256

Or Convert to
2-Speed Version

FLT994222

Rebuild/convert with kit #
FLT24256

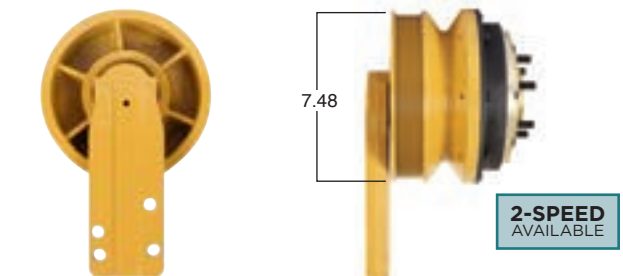

FLT99428 Fleetrite Part Number Rebuild with kit # FLT14256

Or Convert to 2-Speed Version ▶ **FLT994282** Rebuild/convert with kit # FLT24256

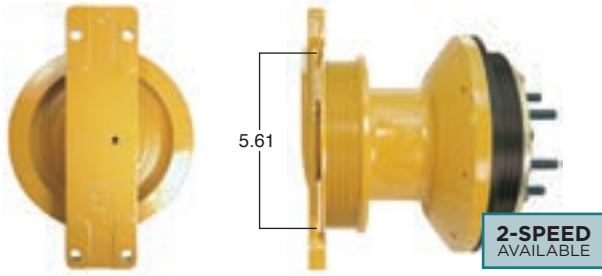

FLT99438 Fleetrite Part Number Rebuild with kit # FLT14256

Or Convert to 2-Speed Version ▶ **FLT994382** Rebuild/convert with kit # FLT24256

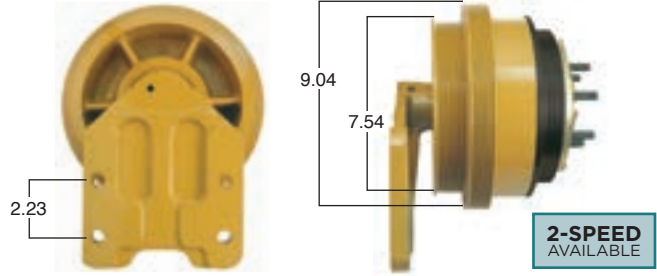

FLT99440 Fleetrite Part Number Rebuild with kit # FLT14256

Or Convert to 2-Speed Version ▶ **FLT994402** Rebuild/convert with kit # FLT24256

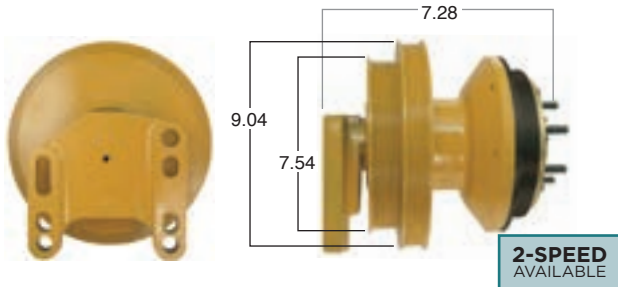

FLT99445 Fleetrite Part Number Rebuild with kit # FLT14256

Or Convert to 2-Speed Version ▶ **FLT994452** Rebuild/convert with kit # FLT24256

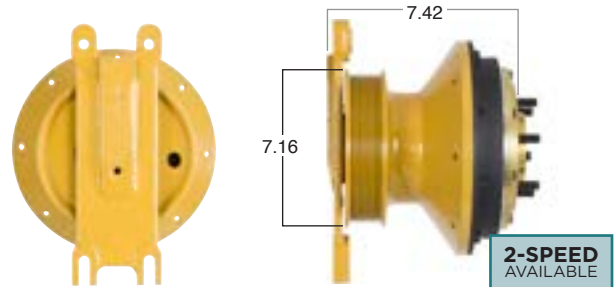

FLT99453 Fleetrite Part Number Rebuild with kit # FLT142561

Or Convert to 2-Speed Version ▶ **FLT994532** Rebuild/convert with kit # FLT242561

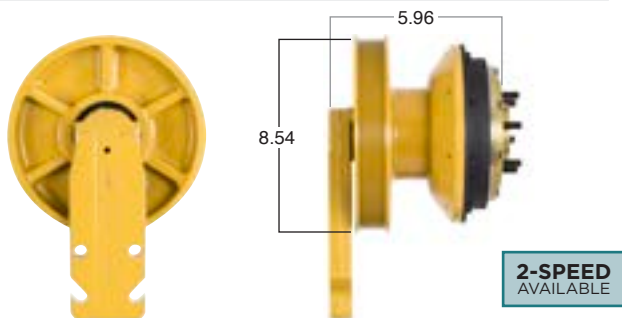

FLT99457 Fleetrite Part Number Rebuild with kit # FLT14256

Or Convert to 2-Speed Version ▶ **FLT994572** Rebuild/convert with kit # FLT24256

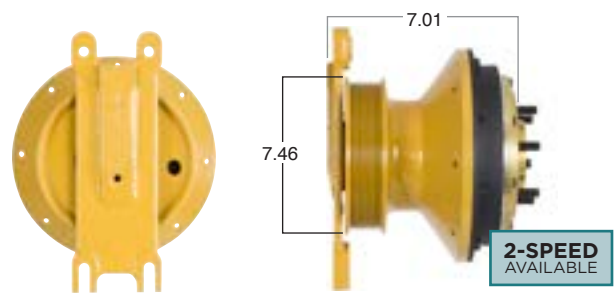

FLT99458 Fleetrite Part Number Rebuild with kit # FLT14256

Or Convert to 2-Speed Version ▶ **FLT994582** Rebuild/convert with kit # FLT24256

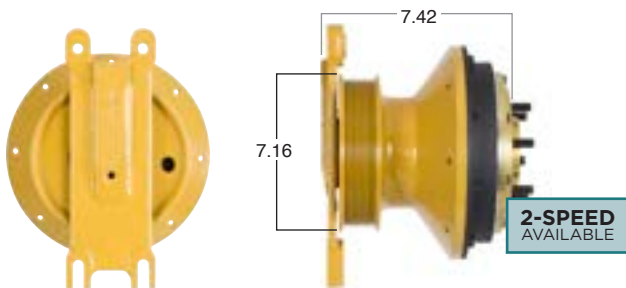

FLT99501 Fleetrite Part Number Rebuild with kit # FLT14256

Or Convert to 2-Speed Version ▶ **FLT995012** Rebuild/convert with kit # FLT24256

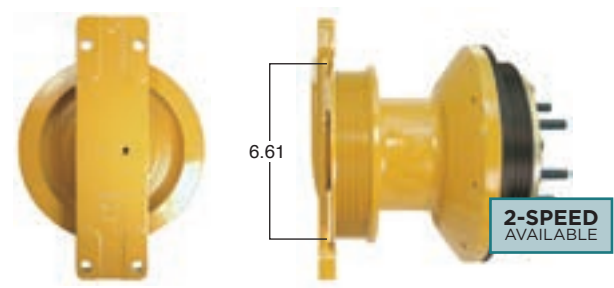

FLT99506

Fleetrite
Part Number

Rebuild with kit #
FLT14256

Or Convert to
2-Speed Version

FLT995062

Rebuild/convert with kit #
FLT24256

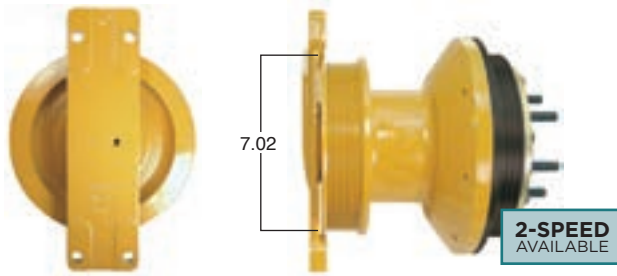

FLT99510

Fleetrite
Part Number

Rebuild with kit #
FLT142561

Or Convert to
2-Speed Version

FLT995102

Rebuild/convert with kit #
FLT242561

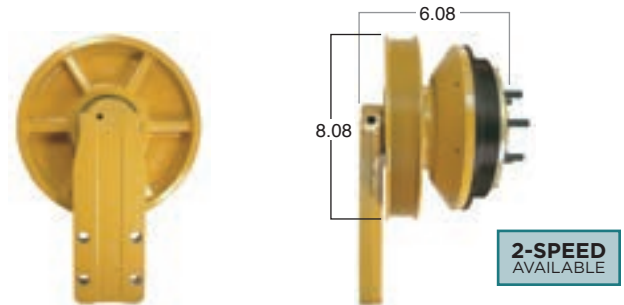

FLT99523

Fleetrite
Part Number

Rebuild with kit #
FLT14256

Or Convert to
2-Speed Version

FLT995232

Rebuild/convert with kit #
FLT24256

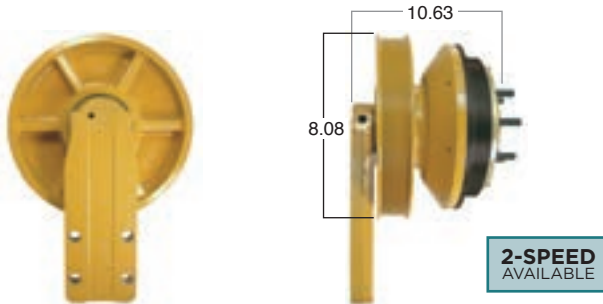

FLT99525

Fleetrite
Part Number

Rebuild with kit #
FLT142561

Or Convert to
2-Speed Version

FLT995252

Rebuild/convert with kit #
FLT242561

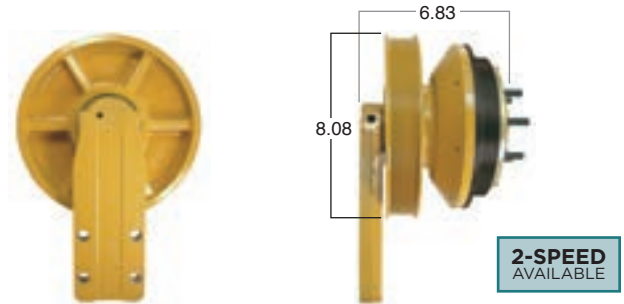

FLT99528

Fleetrite
Part Number

Rebuild with kit #
FLT142561

Or Convert to
2-Speed Version

FLT995282

Rebuild/convert with kit #
FLT242561

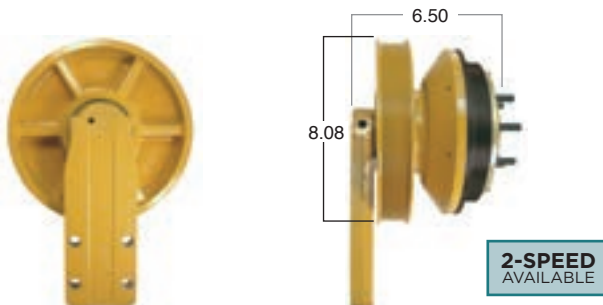

FLT99532

Fleetrite
Part Number

Rebuild with kit #
FLT14256

Or Convert to
2-Speed Version

FLT995322

Rebuild/convert with kit #
FLT24256

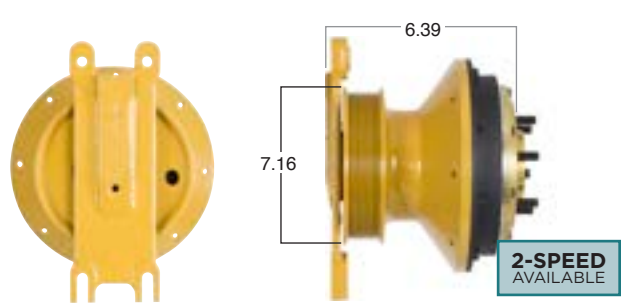

FLT99809

Fleetrite
Part Number

Rebuild with kit #
FLT14256

Or Convert to
2-Speed Version

FLT998092

Rebuild/convert with kit #
FLT24256

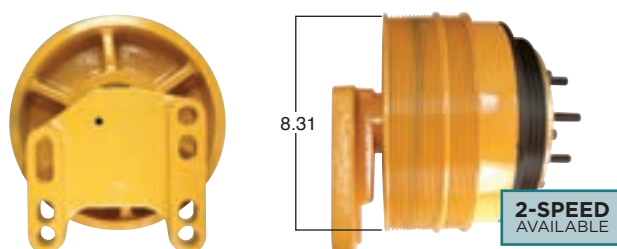

FLT99815

Fleetrite
Part Number

Rebuild with kit #
FLT14256

Or Convert to
2-Speed Version

FLT998152

Rebuild/convert with kit #
FLT24256

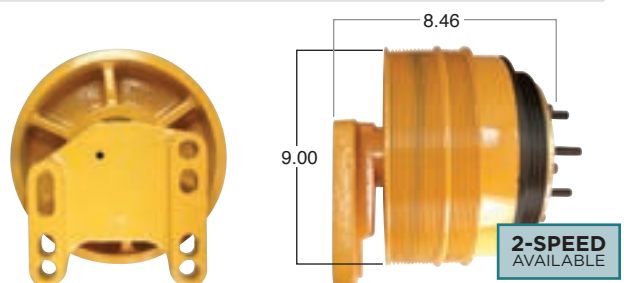

FLT99816 Fleetrite Part Number Rebuild with kit # FLT14256

Or Convert to 2-Speed Version **FLT998162** Rebuild/convert with kit # FLT24256

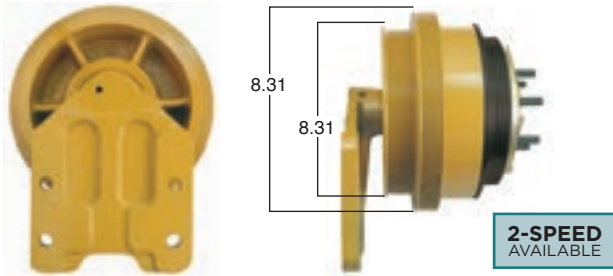

FLT99818 Fleetrite Part Number Rebuild with kit # FLT14256

Or Convert to 2-Speed Version **FLT998182** Rebuild/convert with kit # FLT24256

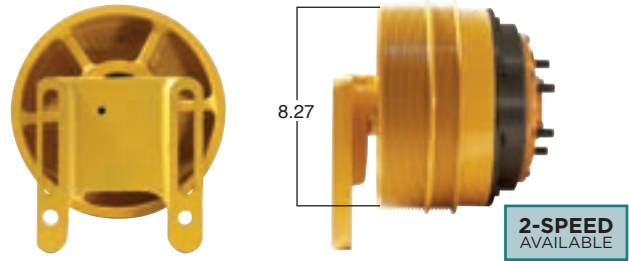

FLT99821 Fleetrite Part Number Rebuild with kit # FLT14256

Or Convert to 2-Speed Version **FLT998212** Rebuild/convert with kit # FLT24256

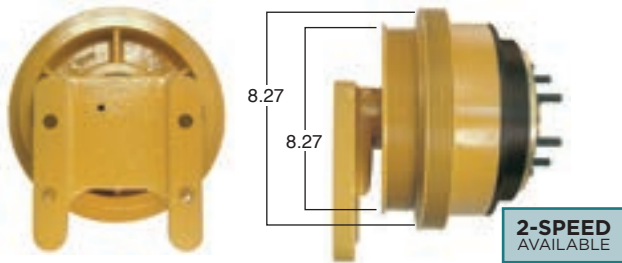

FLT99825 Fleetrite Part Number Rebuild with kit # FLT14256

Or Convert to 2-Speed Version **FLT998252** Rebuild/convert with kit # FLT24256



FLT99827 Fleetrite Part Number Rebuild with kit # FLT14256

Or Convert to 2-Speed Version **FLT998272** Rebuild/convert with kit # FLT24256

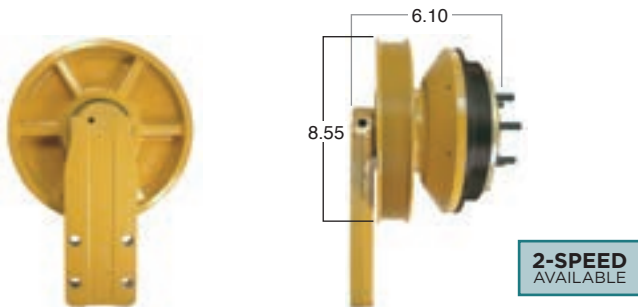

FLT99829 Fleetrite Part Number Rebuild with kit # FLT14256

Or Convert to 2-Speed Version **FLT998292** Rebuild/convert with kit # FLT24256

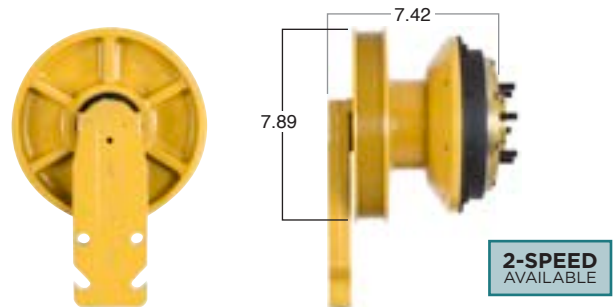

FLT99834 Fleetrite Part Number Rebuild with kit # FLT14256

Or Convert to 2-Speed Version **FLT998342** Rebuild/convert with kit # FLT24256

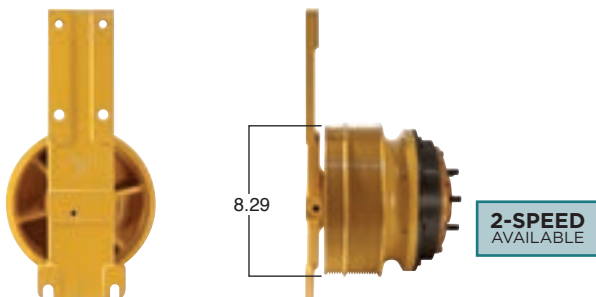

FLT99836 Fleetrite Part Number Rebuild with kit # FLT14256

Or Convert to 2-Speed Version **FLT998362** Rebuild/convert with kit # FLT24256

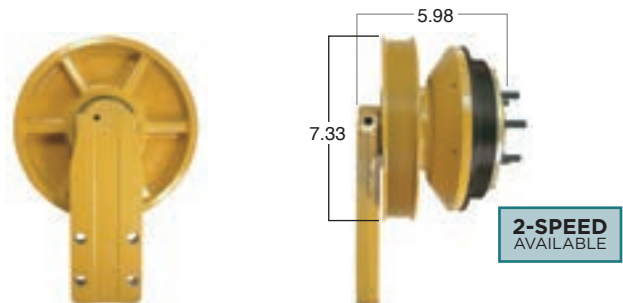

FLT99838

Fleetrite
Part Number

Rebuild with kit #
FLT14256

Or Convert to
2-Speed Version

FLT998382

Rebuild/convert with kit #
FLT24256

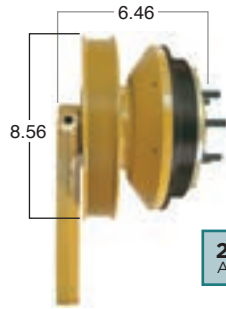

**2-SPEED
AVAILABLE**

FLT99841

Fleetrite
Part Number

Rebuild with kit #
FLT142561

Or Convert to
2-Speed Version

FLT998412

Rebuild/convert with kit #
FLT242561

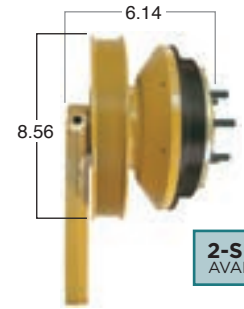

**2-SPEED
AVAILABLE**

FLT99844

Fleetrite
Part Number

Rebuild with kit #
FLT142561

Or Convert to
2-Speed Version

FLT998442

Rebuild/convert with kit #
FLT242561

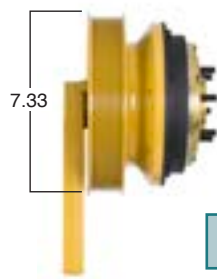

**2-SPEED
AVAILABLE**

FLT99846

Fleetrite
Part Number

Rebuild with kit #
FLT142561

Or Convert to
2-Speed Version

FLT998462

Rebuild/convert with kit #
FLT242561

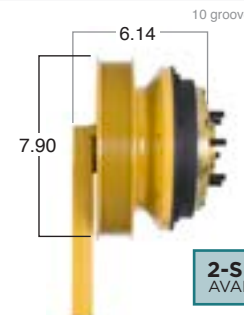

**2-SPEED
AVAILABLE**

FLT99855

Fleetrite
Part Number

Rebuild with kit #
FLT14256

Or Convert to
2-Speed Version

FLT998552

Rebuild/convert with kit #
FLT24256

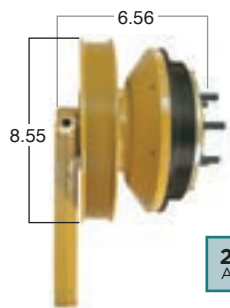

**2-SPEED
AVAILABLE**

FLT99856

Fleetrite
Part Number

Rebuild with kit #
FLT14256

Or Convert to
2-Speed Version

FLT998562

Rebuild/convert with kit #
FLT24256

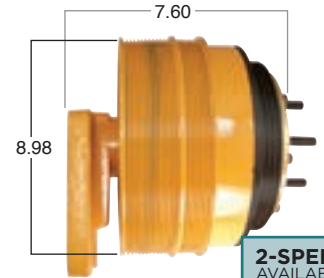

**2-SPEED
AVAILABLE**

FLT99862

Fleetrite
Part Number

Rebuild with kit #
FLT142561

Or Convert to
2-Speed Version

FLT998622

Rebuild/convert with kit #
FLT242561



**2-SPEED
AVAILABLE**

FLT99872

Fleetrite
Part Number

Rebuild with kit #
FLT14256

Or Convert to
2-Speed Version

FLT998722

Rebuild/convert with kit #
FLT24256

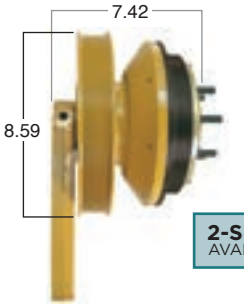

**2-SPEED
AVAILABLE**

FLT99873 Fleetrite Part Number Rebuild with kit # FLT14256

Or Convert to 2-Speed Version **FLT998732** Rebuild/convert with kit # FLT24256

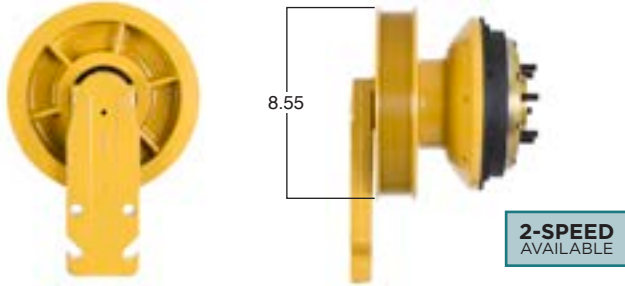

FLT99874 Fleetrite Part Number Rebuild with kit # FLT14256

Or Convert to 2-Speed Version **FLT998742** Rebuild/convert with kit # FLT24256

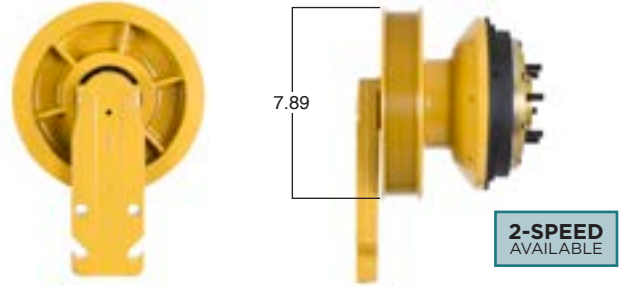

FLT99875 Fleetrite Part Number Rebuild with kit # FLT14256

Or Convert to 2-Speed Version **FLT998752** Rebuild/convert with kit # FLT24256

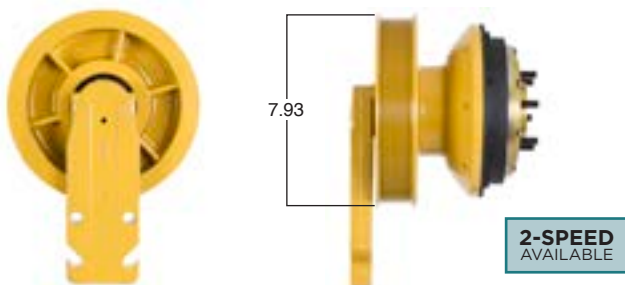

FLT99886 Fleetrite Part Number Rebuild with kit # FLT14256

Or Convert to 2-Speed Version **FLT998862** Rebuild/convert with kit # FLT24256

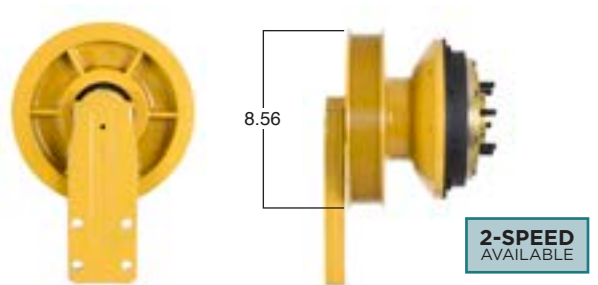

FLT99888 Fleetrite Part Number Rebuild with kit # FLT14256

Or Convert to 2-Speed Version **FLT998882** Rebuild/convert with kit # FLT24256

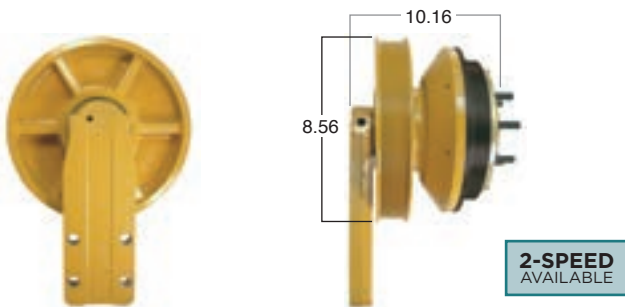

FLT99889 Fleetrite Part Number Rebuild with kit # FLT14256

Or Convert to 2-Speed Version **FLT998892** Rebuild/convert with kit # FLT24256

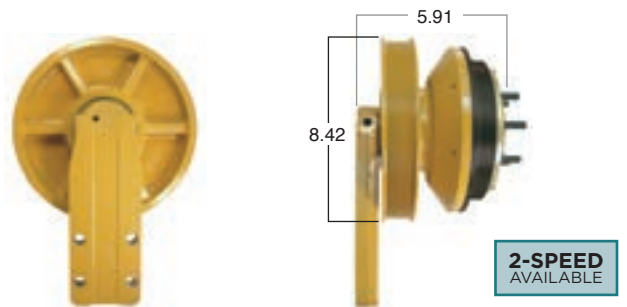

FLT99899 Fleetrite Part Number Rebuild with kit # FLT14256

Or Convert to 2-Speed Version **FLT998992** Rebuild/convert with kit # FLT24256

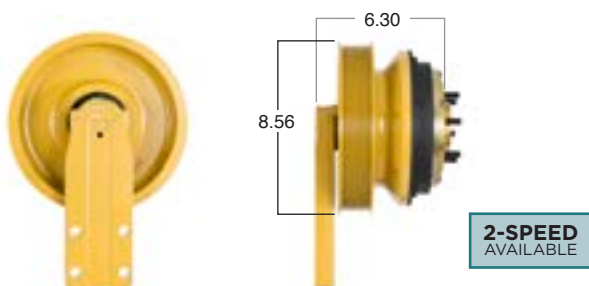

FLT999002 Fleetrite Part Number Rebuild with kit # FLT24256

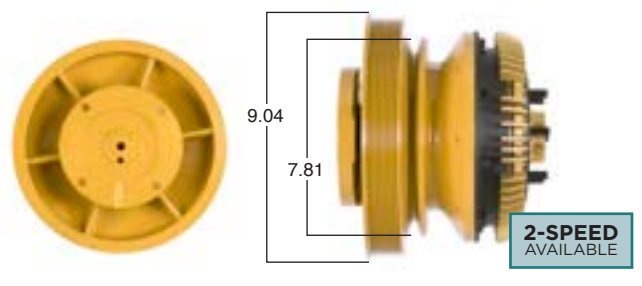

FLT90000 Fleetrite Part Number

Rebuild with kit # **FLT7500HP**

7.5" Friction Plate

2" Fan Pilot

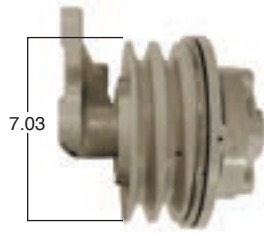

FLT90001 Fleetrite Part Number

Rebuild with kit # **FLT7500HP**

7.5" Friction Plate

2" Fan Pilot

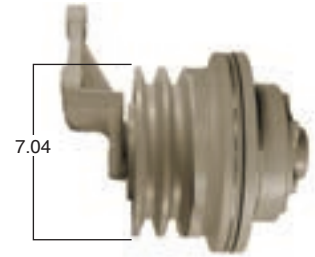

FLT90002 Fleetrite Part Number

Rebuild with kit # **FLT7500HP**

7.5" Friction Plate

2" Fan Pilot

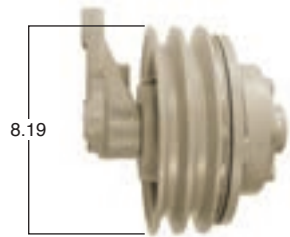

FLT90008 Fleetrite Part Number

Rebuild with kit # **FLT7500HP**

7.5" Friction Plate

2" Fan Pilot



FLT90010 Fleetrite Part Number

Rebuild with kit # **FLT7500HP**

7.5" Friction Plate

2" Fan Pilot



FLT90012 Fleetrite Part Number

Rebuild with kit # **FLT7500HP**

7.5" Friction Plate

2" Fan Pilot



FLT90013 Fleetrite Part Number

Rebuild with kit # **FLT7500HP**

7.5" Friction Plate

2" Fan Pilot



FLT90016 Fleetrite Part Number

Rebuild with kit # **FLT7500HP**

7.5" Friction Plate

5" Fan Pilot



FLT90017

Fleetrite
Part Number

Rebuild with kit #
FLT7500HP

7.5" Friction Plate

2" Fan Pilot

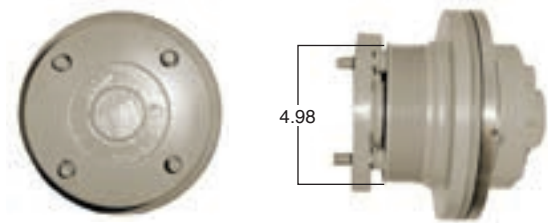

FLT90021

Fleetrite
Part Number

Rebuild with kit #
FLT7500HP

7.5" Friction Plate

5" Fan Pilot

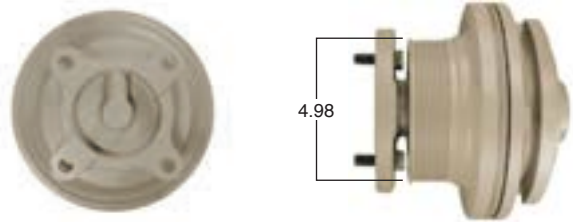

FLT90023

Fleetrite
Part Number

Rebuild with kit #
FLT7500HP

7.5" Friction Plate

2" Fan Pilot

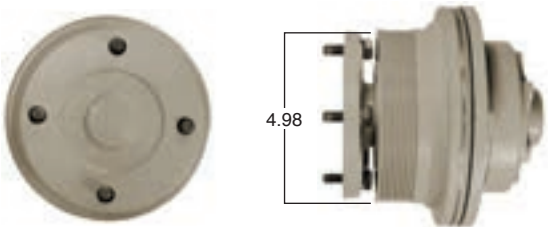

FLT90024

Fleetrite
Part Number

Rebuild with kit #
FLT7500HP

7.5" Friction Plate

2" Fan Pilot

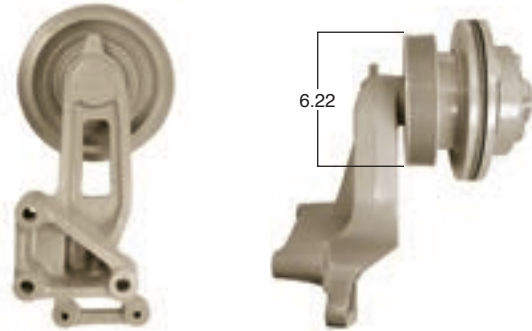

FLT90025

Fleetrite
Part Number

Rebuild with kit #
FLT7500HP

7.5" Friction Plate

2" Fan Pilot

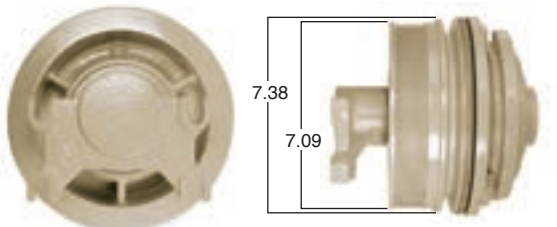

FLT90027

Fleetrite
Part Number

Rebuild with kit #
FLT7500HP

7.5" Friction Plate

2" Fan Pilot

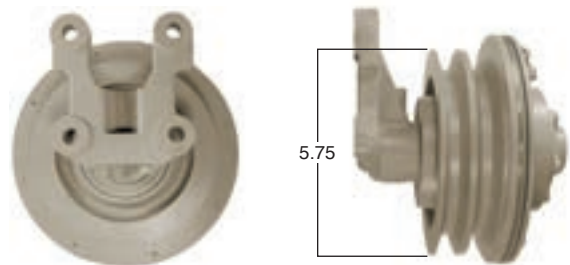

FLT90031

Fleetrite
Part Number

Rebuild with kit #
FLT7500HP

7.5" Friction Plate

2" Fan Pilot

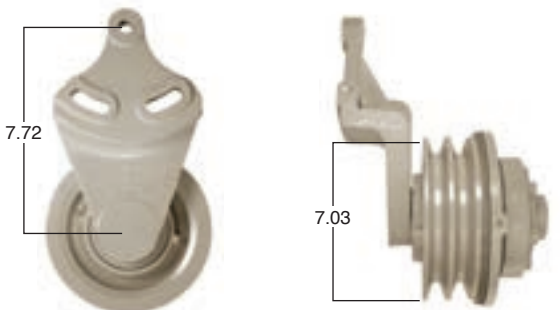

FLT90032

Fleetrite
Part Number

Rebuild with kit #
FLT7500HP

7.5" Friction Plate

2" Fan Pilot

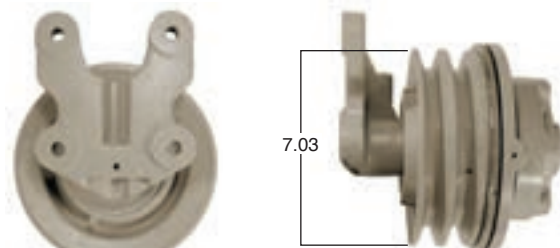

FLT91000 Fleetrite Part Number

Rebuild with kit # FLT9500HP

9.5" Friction Plate

2" Fan Pilot

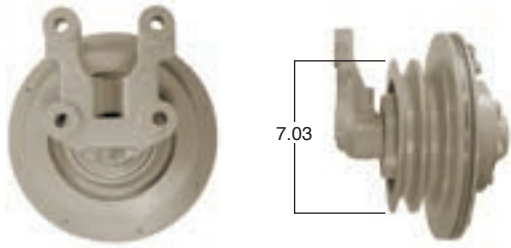

FLT91001 Fleetrite Part Number

Rebuild with kit # FLT9500HP

9.5" Friction Plate

2" Fan Pilot

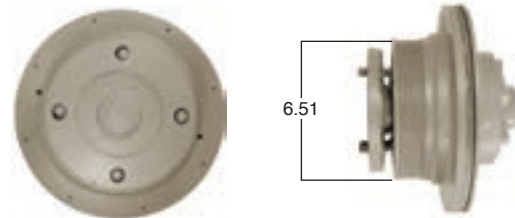

FLT91004 Fleetrite Part Number

Rebuild with kit # FLT9500HP

9.5" Friction Plate

2" Fan Pilot

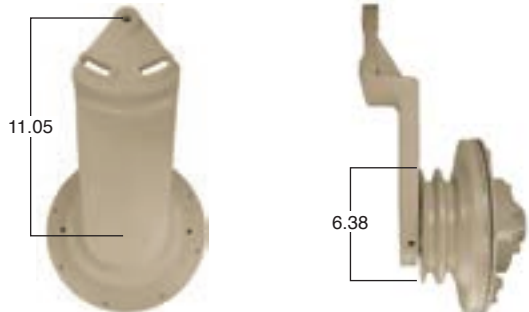

FLT91006 Fleetrite Part Number

Rebuild with kit # FLT9500HP

9.5" Friction Plate

2" Fan Pilot



FLT91009 Fleetrite Part Number

Rebuild with kit # FLT9500HP

9.5" Friction Plate

2" Fan Pilot



FLT91010 Fleetrite Part Number

Rebuild with kit # FLT9500HP

9.5" Friction Plate

5" Fan Pilot

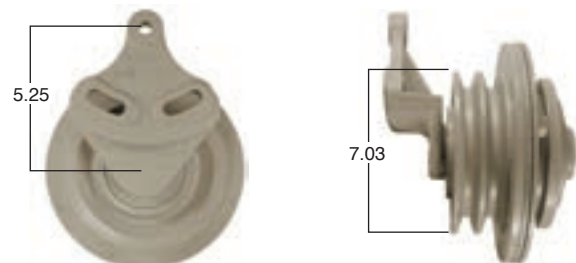

FLT91016 Fleetrite Part Number

Rebuild with kit # FLT9500HP

9.5" Friction Plate

2" Fan Pilot

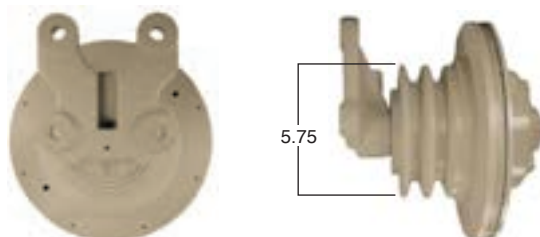

FLT91018 Fleetrite Part Number

Rebuild with kit # FLT9500HP

9.5" Friction Plate

5" Fan Pilot

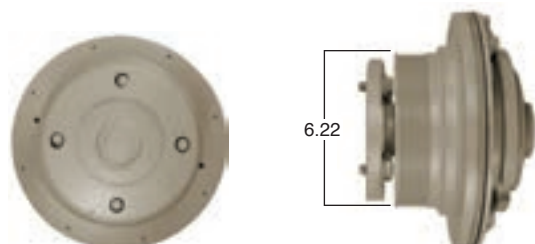

FLT91019

Fleetrite
Part Number

Rebuild with kit #
FLT9500HP

9.5" Friction Plate

5" Fan Pilot

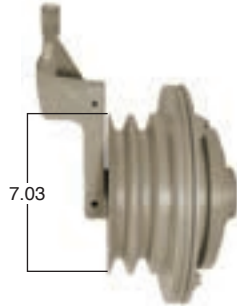

FLT91021

Fleetrite
Part Number

Rebuild with kit #
FLT9500HP

9.5" Friction Plate

5" Fan Pilot



FLT91022

Fleetrite
Part Number

Rebuild with kit #
FLT9500HP

9.5" Friction Plate

5" Fan Pilot



FLT91026

Fleetrite
Part Number

Rebuild with kit #
FLT9500HP

9.5" Friction Plate

2" Fan Pilot

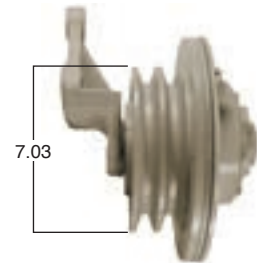

FLT91029

Fleetrite
Part Number

Rebuild with kit #
FLT9500HP

9.5" Friction Plate

5" Fan Pilot



FLT91030

Fleetrite
Part Number

Rebuild with kit #
FLT9500HP

9.5" Friction Plate

5" Fan Pilot



FLT91032

Fleetrite
Part Number

Rebuild with kit #
FLT9500HP

9.5" Friction Plate

5" Fan Pilot



FLT91034

Fleetrite
Part Number

Rebuild with kit #
FLT9500HP

9.5" Friction Plate

5" Fan Pilot

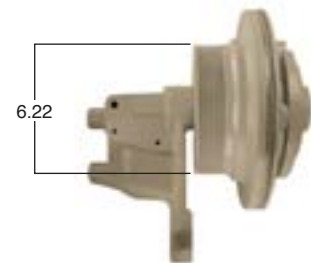

FLT91036 Fleetrite Part Number Rebuild with kit # FLT9500HP

9.5" Friction Plate 2" Fan Pilot

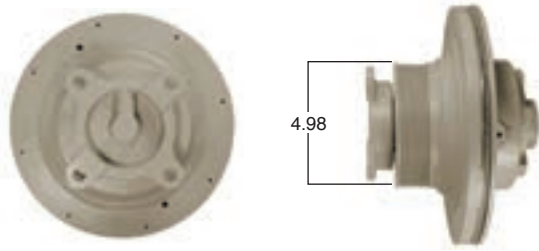

FLT91044 Fleetrite Part Number Rebuild with kit # FLT9500HP

9.5" Friction Plate 2.56" Fan Pilot

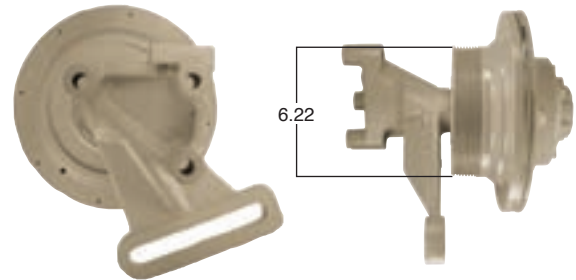

FLT91045 Fleetrite Part Number Rebuild with kit # FLT9500HP

9.5" Friction Plate 2.56" Fan Pilot

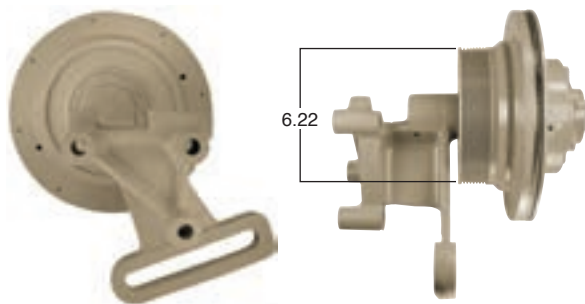

FLT91054 Fleetrite Part Number Rebuild with kit # FLT9500HP

9.5" Friction Plate 5" Fan Pilot

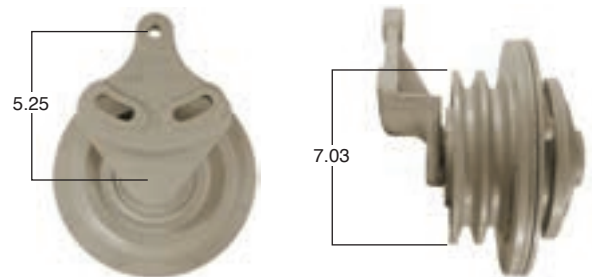

FLT91055 Fleetrite Part Number Rebuild with kit # FLT9500HP

9.5" Friction Plate 5" Fan Pilot

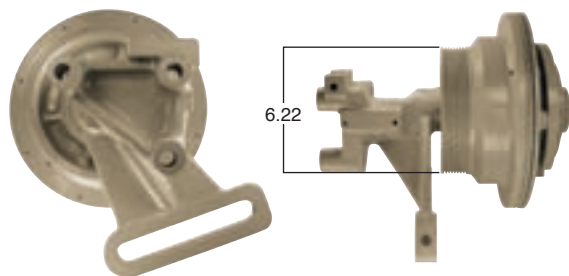

FLT91056 Fleetrite Part Number Rebuild with kit # FLT9500HP

9.5" Friction Plate 5" Fan Pilot



FLT91058 Fleetrite Part Number Rebuild with kit # FLT9500HP

9.5" Friction Plate 2.56" Fan Pilot

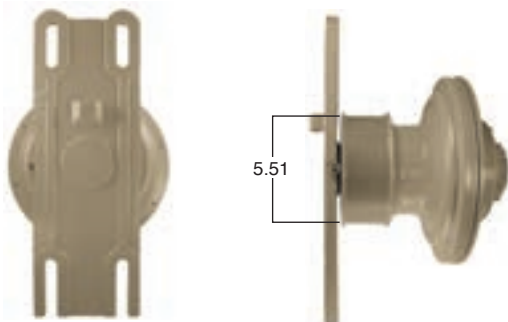

FLT91061 Fleetrite Part Number Rebuild with kit # FLT9500HP

9.5" Friction Plate 2.56" Fan Pilot

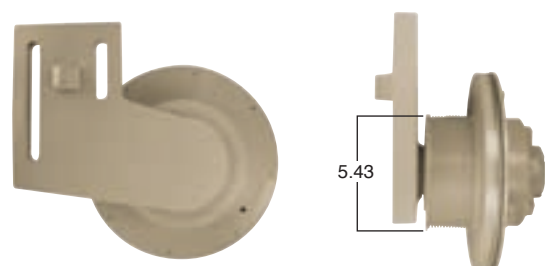

FLT91064

Fleetrite
Part Number

Rebuild with kit #
FLT9500HP

9.5" Friction Plate

5" Fan Pilot
Same as FLT91019

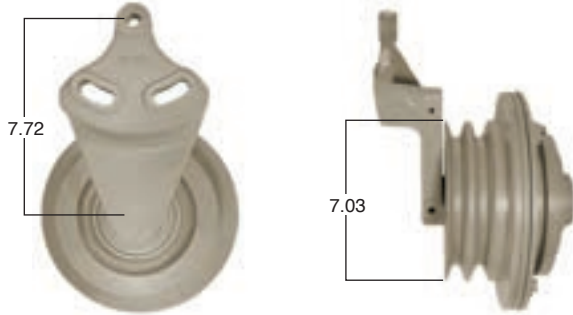

FLT91072

Fleetrite
Part Number

Rebuild with kit #
FLT9500HP

9.5" Friction Plate

2" Fan Pilot

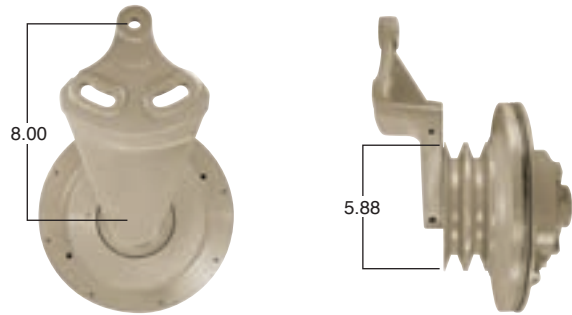

FLT91073

Fleetrite
Part Number

Rebuild with kit #
FLT9500HP

9.5" Friction Plate

2.56" Fan Pilot

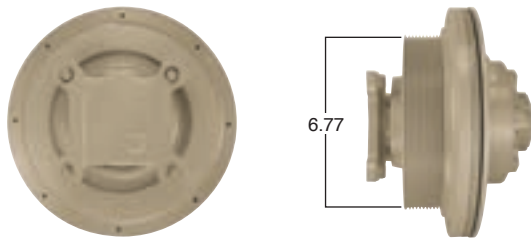

FLT91074

Fleetrite
Part Number

Rebuild with kit #
FLT9500HP

9.5" Friction Plate

2" Fan Pilot

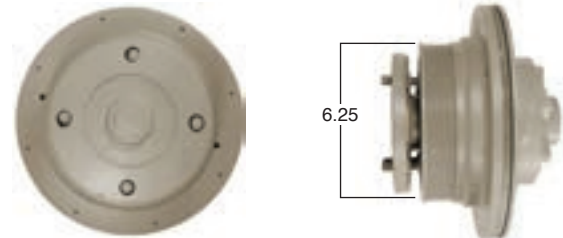

FLT91075

Fleetrite
Part Number

Rebuild with kit #
FLT9500HP

9.5" Friction Plate

2" Fan Pilot

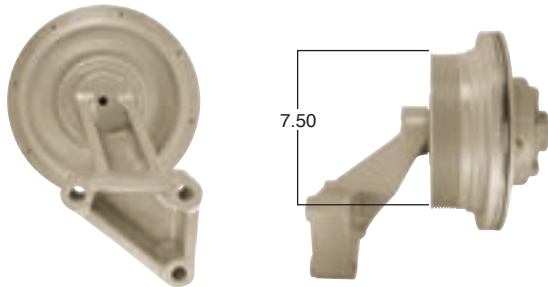

FLT91078

Fleetrite
Part Number

Rebuild with kit #
FLT9500HP

9.5" Friction Plate

2" Fan Pilot

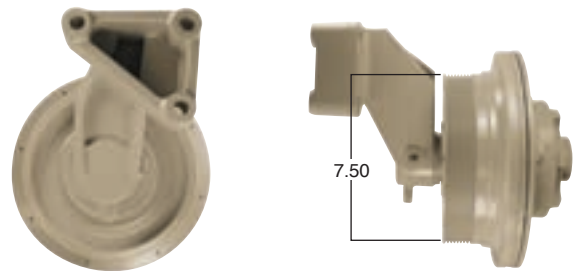

FLT91079

Fleetrite
Part Number

Rebuild with kit #
FLT9500HP

9.5" Friction Plate

2" Fan Pilot

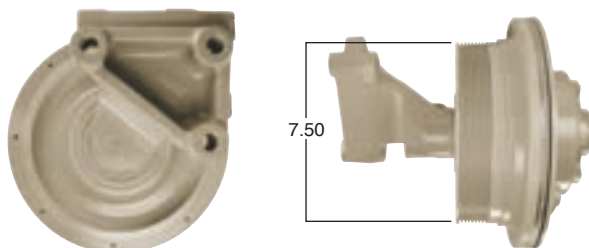

FLT91080

Fleetrite
Part Number

Rebuild with kit #
FLT9500HP

9.5" Friction Plate

2" Fan Pilot

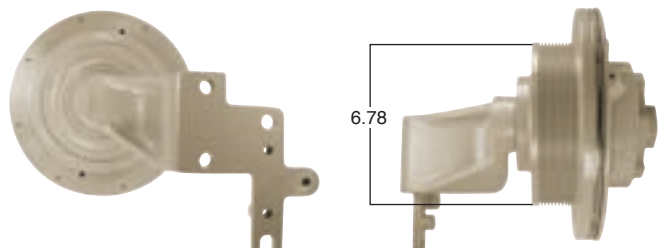

FLT91086 Fleetrite Part Number

Rebuild with kit # FLT9500HP

9.5" Friction Plate

2" Fan Pilot

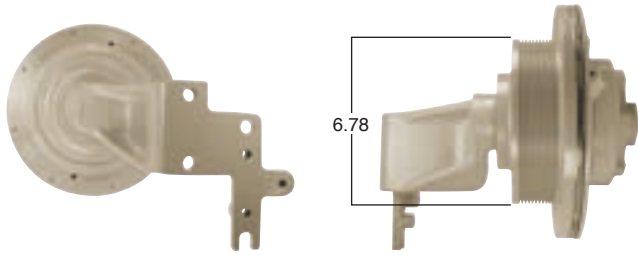

FLT91088 Fleetrite Part Number

Rebuild with kit # FLT9500HP

9.5" Friction Plate

2" Fan Pilot

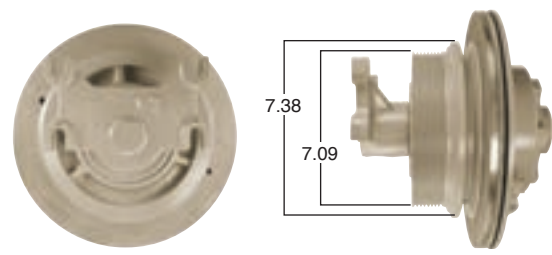

FLT91092 Fleetrite Part Number

Rebuild with kit # FLT9500HP

9.5" Friction Plate

2" Fan Pilot

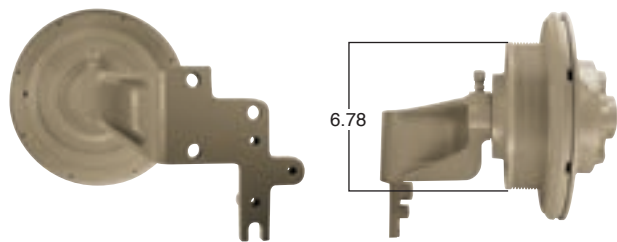

FLT91093 Fleetrite Part Number

Rebuild with kit # FLT9504HP

9.5" Friction Plate

2.56" Fan Pilot
Special Bearing Kit

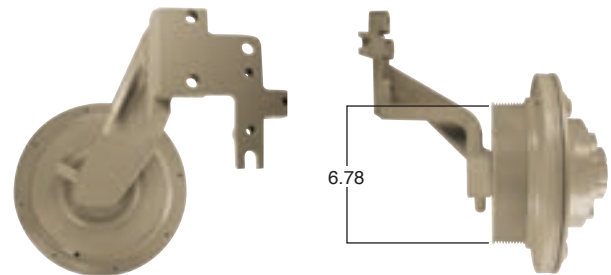

FLT91094 Fleetrite Part Number

Rebuild with kit # FLT9500HP

9.5" Friction Plate

2.56" Fan Pilot

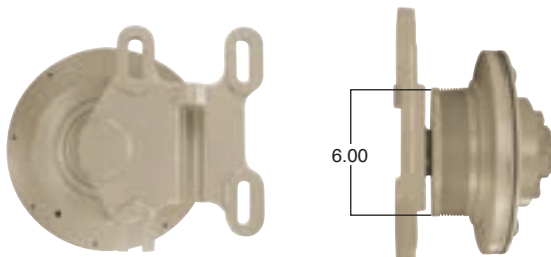

FLT91095 Fleetrite Part Number

Rebuild with kit # FLT9500HP

9.5" Friction Plate

2.56" Fan Pilot

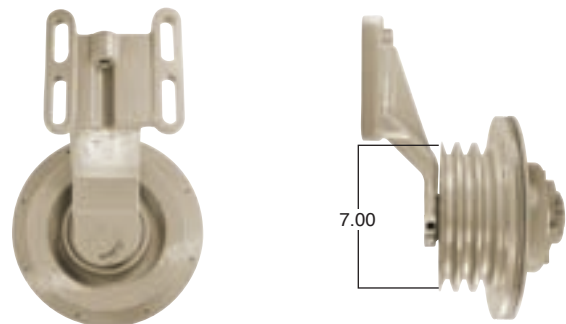

FLT91096 Fleetrite Part Number

Rebuild with kit # FLT9500HP

9.5" Friction Plate

2" Fan Pilot
Same as FLT91072

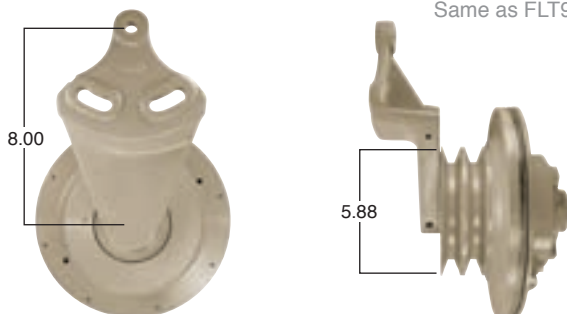

FLT91099 Fleetrite Part Number

Rebuild with kit # FLT9500HP

9.5" Friction Plate

5" Fan Pilot



FLT91100

Fleetrite
Part Number

Rebuild with kit #
FLT9500HP

9.5" Friction Plate

5" Fan Pilot

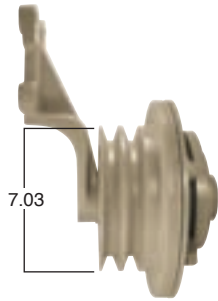

FLT91101

Fleetrite
Part Number

Rebuild with kit #
FLT9500HP

9.5" Friction Plate

2" Fan Pilot

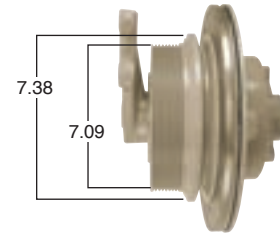

FLT91103

Fleetrite
Part Number

Rebuild with kit #
FLT9500HP

9.5" Friction Plate

2" Fan Pilot

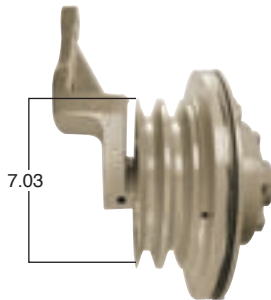

FLT91104

Fleetrite
Part Number

Rebuild with kit #
FLT9500HP

9.5" Friction Plate

2" Fan Pilot

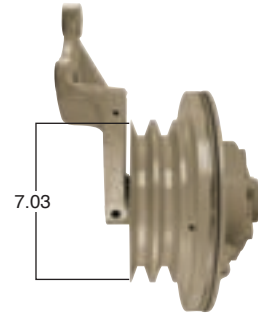

FLT91108

Fleetrite
Part Number

Rebuild with kit #
FLT9500HP

9.5" Friction Plate

2" Fan Pilot

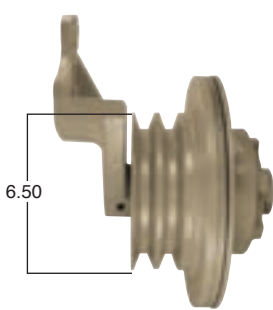

FLT91109

Fleetrite
Part Number

Rebuild with kit #
FLT9500HP

9.5" Friction Plate

2" Fan Pilot

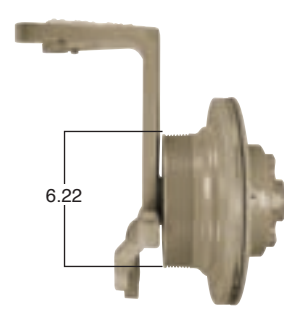

FLT91110

Fleetrite
Part Number

Rebuild with kit #
FLT9500HP

9.5" Friction Plate

2" Fan Pilot

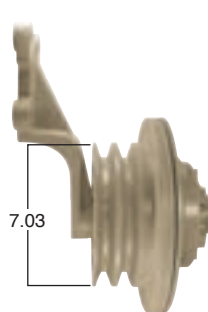

FLT91111

Fleetrite
Part Number

Rebuild with kit #
FLT9500HP

9.5" Friction Plate

2.56" Fan Pilot

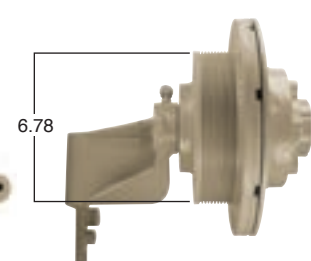

FLT91112 Fleetrite Part Number

Rebuild with kit # **FLT9500HP**

9.5" Friction Plate

2" Fan Pilot

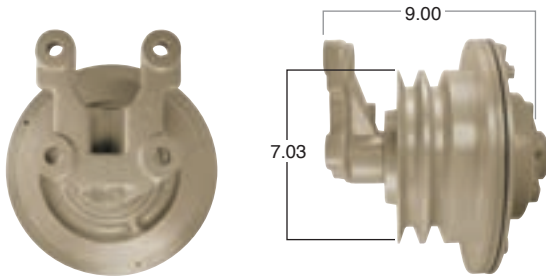

FLT91113 Fleetrite Part Number

Rebuild with kit # **FLT9500HP**

9.5" Friction Plate

2" Fan Pilot
Same as FLT91009

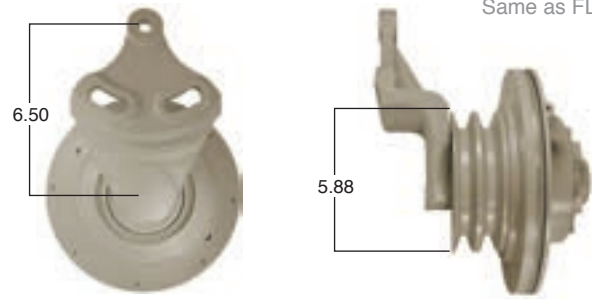

FLT98600 Fleetrite Part Number

Rebuild with kit # **FLT14256**

Or Convert to 2-Speed Version

FLT986002

Rebuild/convert with kit # **FLT24256**

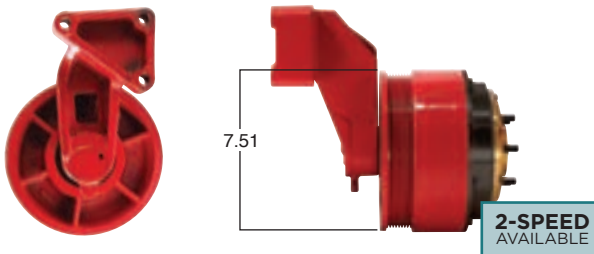

FLT98601 Fleetrite Part Number

Rebuild with kit # **FLT14256**

Or Convert to 2-Speed Version

FLT986012

Rebuild/convert with kit # **FLT24256**

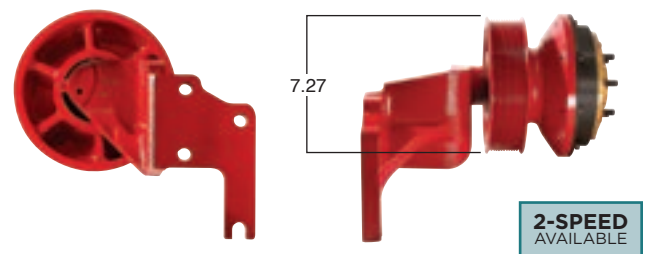

FLT99002 Fleetrite Part Number

Rebuild with kit # **FLT14200**

Or Convert to 2-Speed Version

FLT990022

Rebuild/convert with kit # **FLT24200**

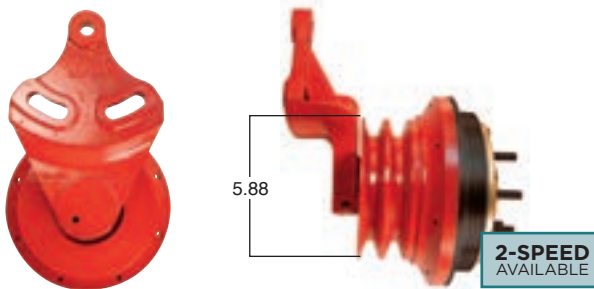

FLT99004 Fleetrite Part Number

Rebuild with kit # **FLT14256**

Or Convert to 2-Speed Version

FLT990042

Rebuild/convert with kit # **FLT24256**

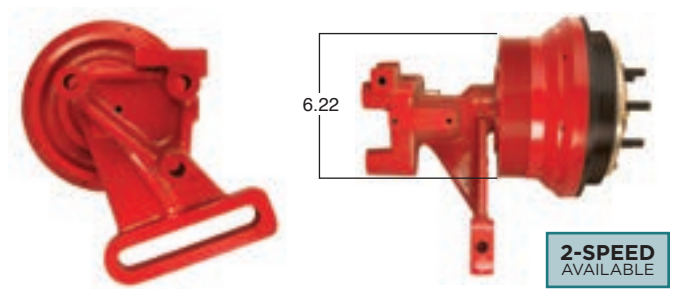

FLT99005 Fleetrite Part Number

Rebuild with kit # **FLT14256**

Or Convert to 2-Speed Version

FLT990052

Rebuild/convert with kit # **FLT24256**

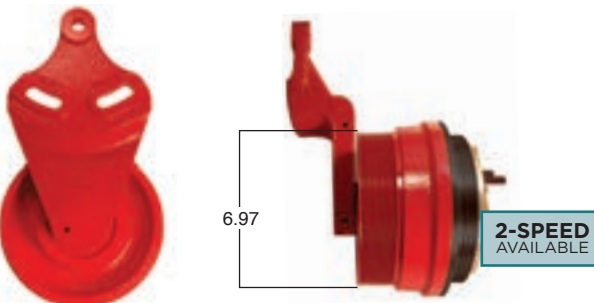

FLT99010 Fleetrite Part Number

Rebuild with kit # **FLT142561**

Or Convert to 2-Speed Version

FLT990102

Rebuild/convert with kit # **FLT242561**

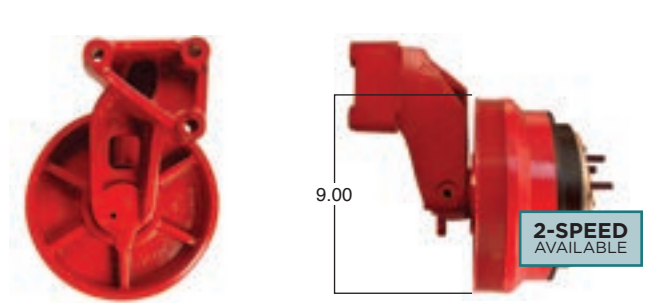

FLT99011 Fleetrite Part Number Rebuild with kit # **FLT142561**
 Or Convert to 2-Speed Version ▶ **FLT990112** Rebuild/convert with kit # **FLT242561**

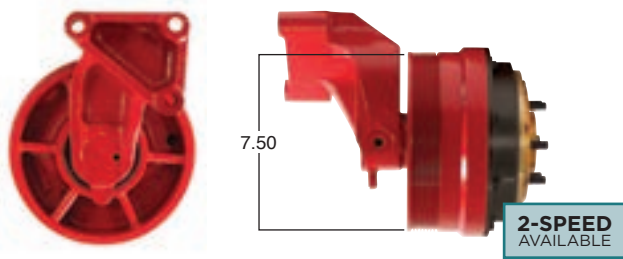

FLT99014 Fleetrite Part Number Rebuild with kit # **FLT14256**
 Or Convert to 2-Speed Version ▶ **FLT990142** Rebuild/convert with kit # **FLT24256**

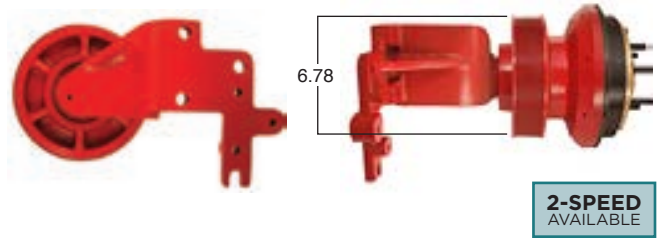

FLT99015 Fleetrite Part Number Rebuild with kit # **FLT14256**
 Or Convert to 2-Speed Version ▶ **FLT990152** Rebuild/convert with kit # **FLT24256**

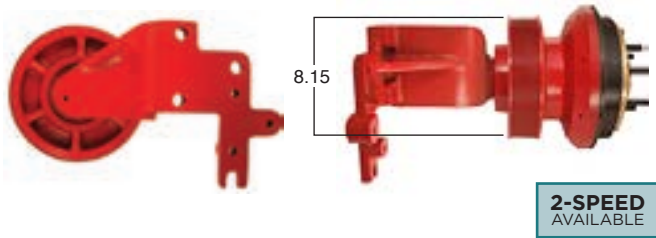

FLT99025 Fleetrite Part Number Rebuild with kit # **FLT14200**
 Or Convert to 2-Speed Version ▶ **FLT990252** Rebuild/convert with kit # **FLT24200**

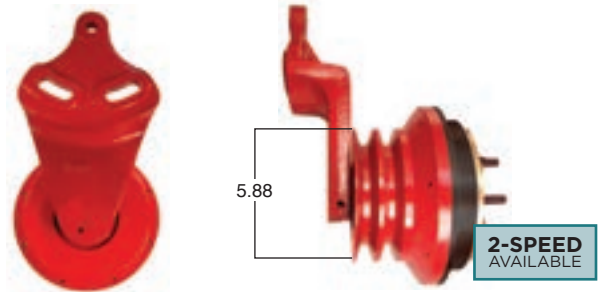

FLT99026 Fleetrite Part Number Rebuild with kit # **FLT14256**
 Or Convert to 2-Speed Version ▶ **FLT990262** Rebuild/convert with kit # **FLT24256**

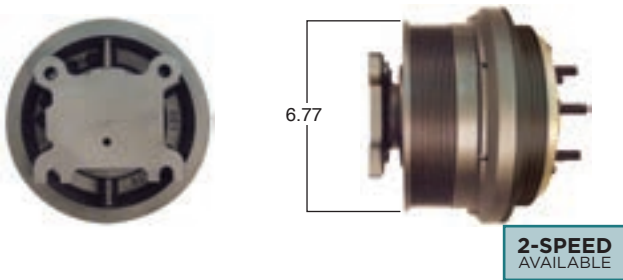

FLT99030 Fleetrite Part Number Rebuild with kit # **FLT142561**
 Or Convert to 2-Speed Version ▶ **FLT990302** Rebuild/convert with kit # **FLT242561**

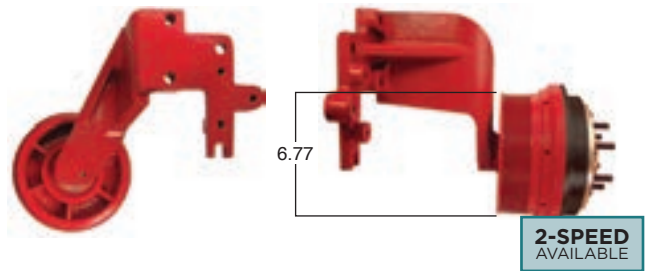

FLT99035 Fleetrite Part Number Rebuild with kit # **FLT14256**
 Or Convert to 2-Speed Version ▶ **FLT990352** Rebuild/convert with kit # **FLT24256**

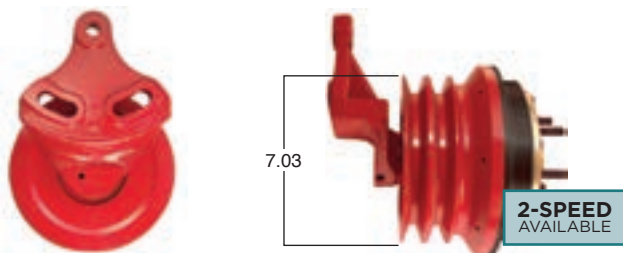

FLT99036 Fleetrite Part Number Rebuild with kit # **FLT14256**
 Or Convert to 2-Speed Version ▶ **FLT990362** Rebuild/convert with kit # **FLT24256**

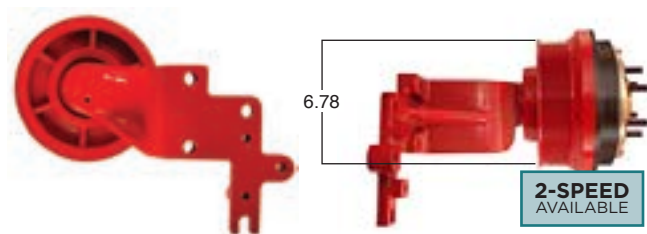

FLT99045

Fleetrite Part Number

Rebuild with kit # FLT14256

Or Convert to 2-Speed Version

FLT990452

Rebuild/convert with kit # FLT24256

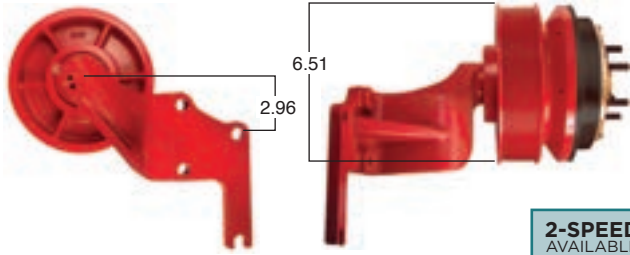

2-SPEED AVAILABLE

FLT99048

Fleetrite Part Number

Rebuild with kit # FLT14256

Or Convert to 2-Speed Version

FLT990482

Rebuild/convert with kit # FLT24256

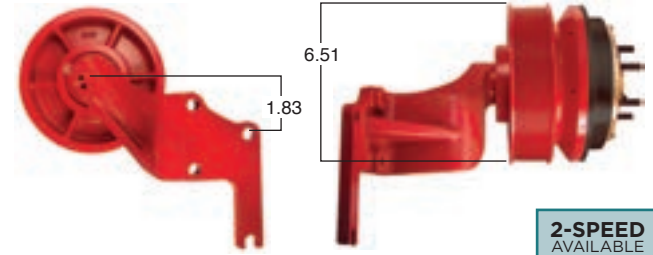

2-SPEED AVAILABLE

FLT99050

Fleetrite Part Number

Rebuild with kit # FLT14256

Or Convert to 2-Speed Version

FLT990502

Rebuild/convert with kit # FLT24256

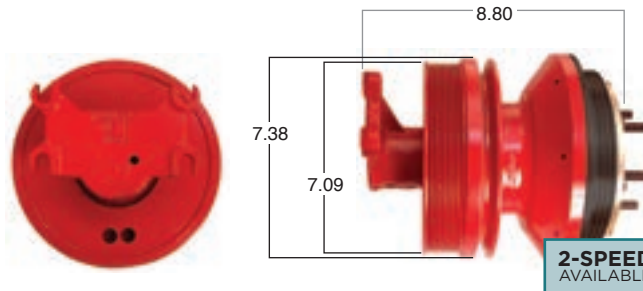

2-SPEED AVAILABLE

FLT99051

Fleetrite Part Number

Rebuild with kit # FLT14256

Or Convert to 2-Speed Version

FLT990512

Rebuild/convert with kit # FLT24256

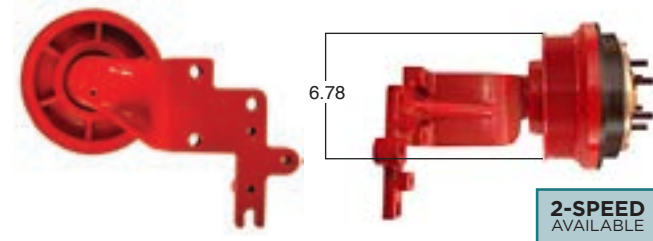

2-SPEED AVAILABLE

FLT99052

Fleetrite Part Number

Rebuild with kit # FLT14256

Or Convert to 2-Speed Version

FLT990522

Rebuild/convert with kit # FLT24256

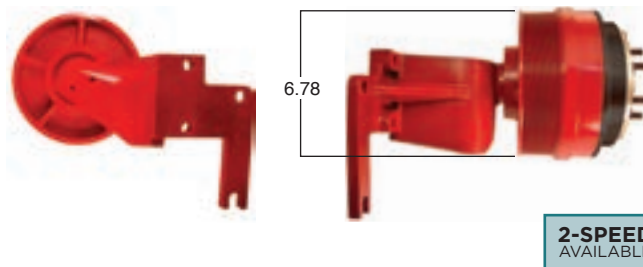

2-SPEED AVAILABLE

FLT99053

Fleetrite Part Number

Rebuild with kit # FLT14256

Or Convert to 2-Speed Version

FLT990532

Rebuild/convert with kit # FLT24256

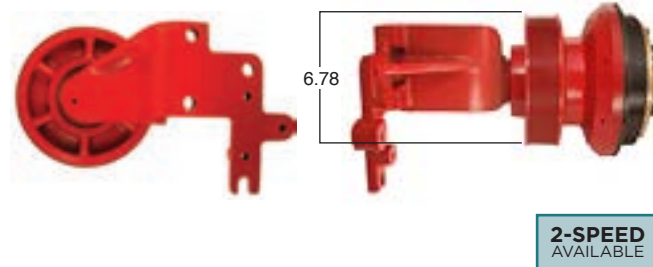

2-SPEED AVAILABLE

FLT99054

Fleetrite Part Number

Rebuild with kit # FLT14256

Or Convert to 2-Speed Version

FLT990542

Rebuild/convert with kit # FLT24256

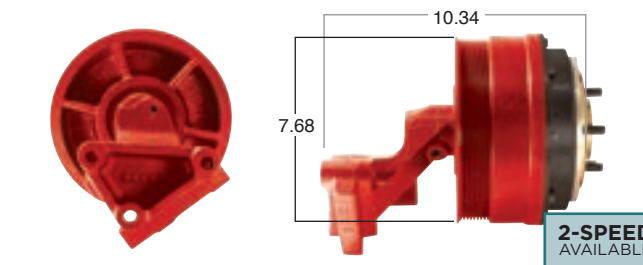

2-SPEED AVAILABLE

FLT99055

Fleetrite Part Number

Rebuild with kit # FLT14256

Or Convert to 2-Speed Version

FLT990552

Rebuild/convert with kit # FLT24256

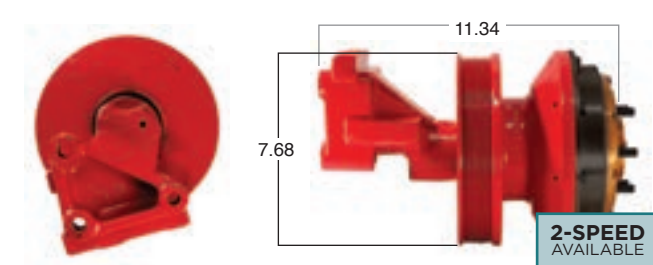

2-SPEED AVAILABLE

FLT99056 Fleetrite Part Number Rebuild with kit # FLT14256

Or Convert to 2-Speed Version ▶ **FLT990562** Rebuild/convert with kit # FLT24256

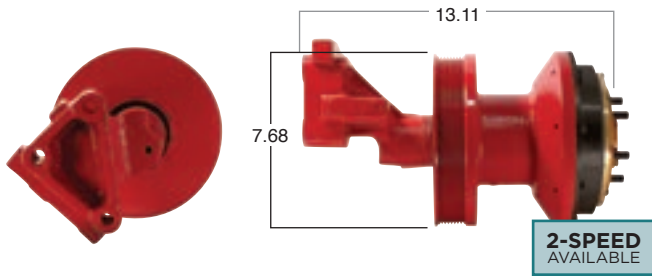

FLT99057 Fleetrite Part Number Rebuild with kit # FLT14256

Or Convert to 2-Speed Version ▶ **FLT990572** Rebuild/convert with kit # FLT24256

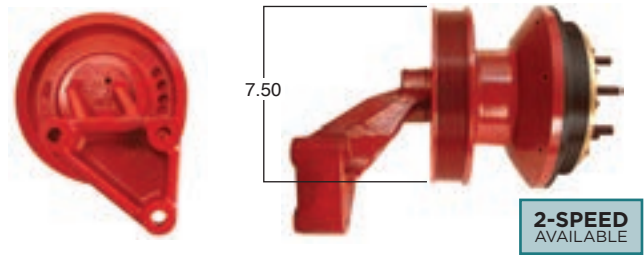

FLT99058 Fleetrite Part Number Rebuild with kit # FLT14256

Or Convert to 2-Speed Version ▶ **FLT990582** Rebuild/convert with kit # FLT24256

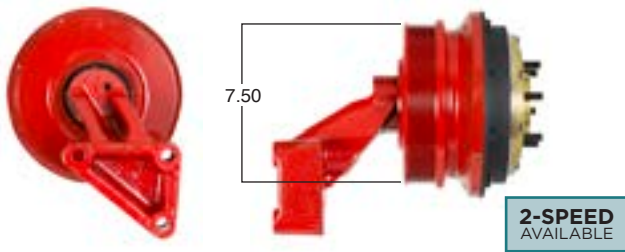

FLT99059 Fleetrite Part Number Rebuild with kit # FLT14256

Or Convert to 2-Speed Version ▶ **FLT990592** Rebuild/convert with kit # FLT24256

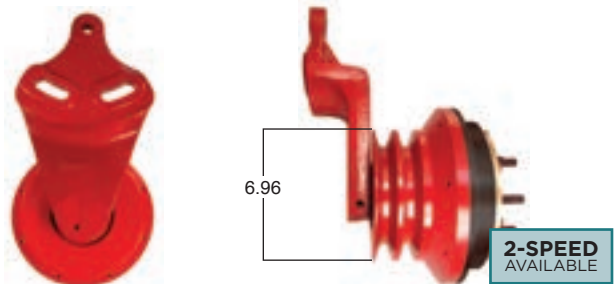

FLT99060 Fleetrite Part Number Rebuild with kit # FLT14256

Or Convert to 2-Speed Version ▶ **FLT990602** Rebuild/convert with kit # FLT24256

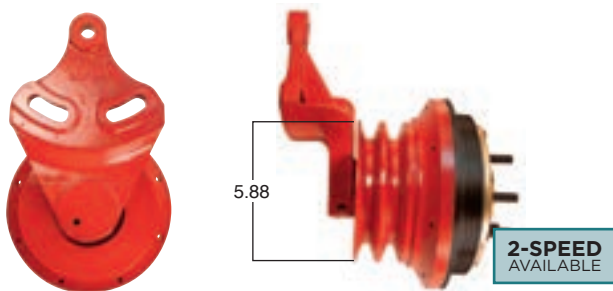

FLT99081 Fleetrite Part Number Rebuild with kit # FLT14256

Or Convert to 2-Speed Version ▶ **FLT990812** Rebuild/convert with kit # FLT24256

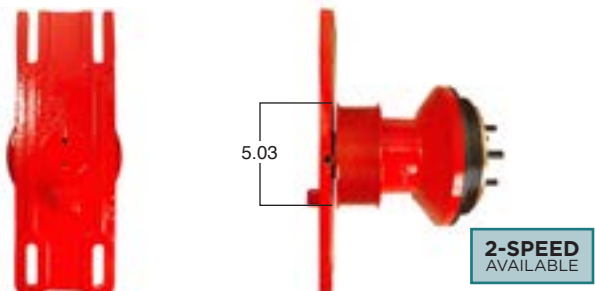

FLT99082 Fleetrite Part Number Rebuild with kit # FLT14256

Or Convert to 2-Speed Version ▶ **FLT990822** Rebuild/convert with kit # FLT24256

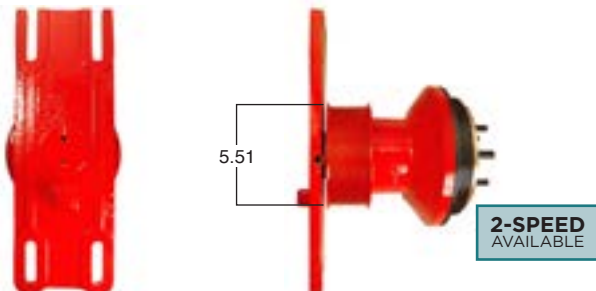

FLT99088 Fleetrite Part Number Rebuild with kit # FLT14256

Or Convert to 2-Speed Version ▶ **FLT990882** Rebuild/convert with kit # FLT24256

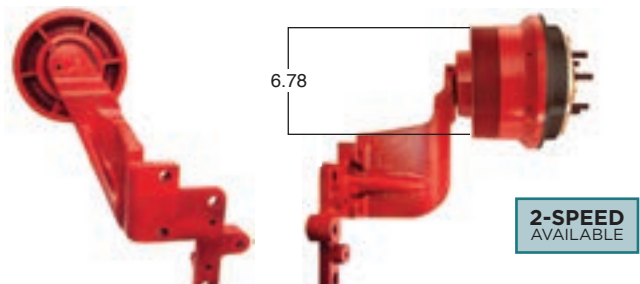

FLT99090

Fleetrite
Part Number

Rebuild with kit #
FLT14256

Or Convert to
2-Speed Version

FLT990902

Rebuild/convert with kit #
FLT24256

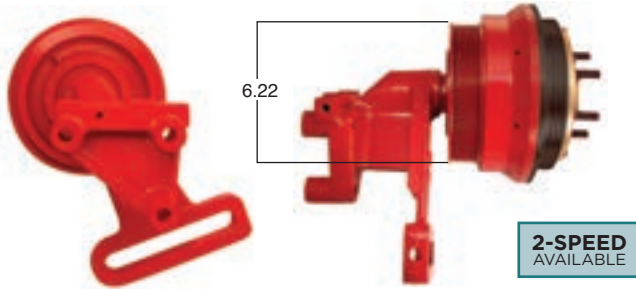

FLT99094

Fleetrite
Part Number

Rebuild with kit #
FLT14256

Or Convert to
2-Speed Version

FLT990942

Rebuild/convert with kit #
FLT24256

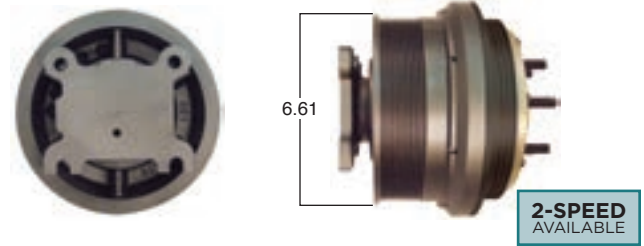

FLT99095

Fleetrite
Part Number

Rebuild with kit #
FLT14256

Or Convert to
2-Speed Version

FLT990952

Rebuild/convert with kit #
FLT24256

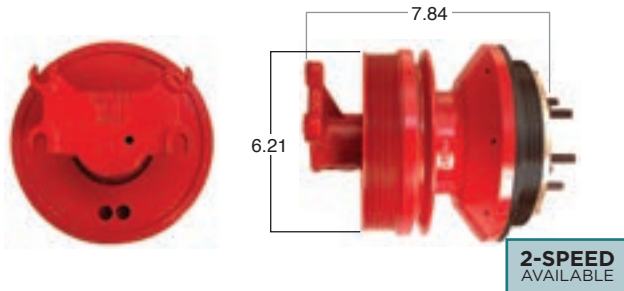

FLT99097

Fleetrite
Part Number

Rebuild with kit #
FLT14256

Or Convert to
2-Speed Version

FLT990972

Rebuild/convert with kit #
FLT24256

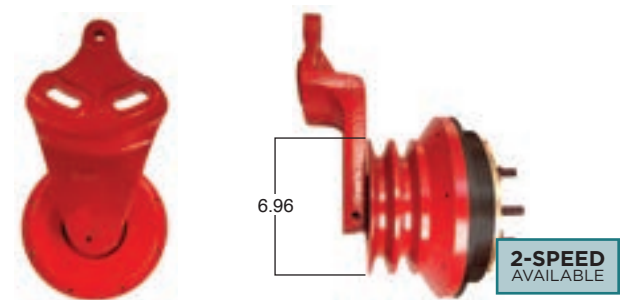

FLT99099

Fleetrite
Part Number

Rebuild with kit #
FLT14256

Or Convert to
2-Speed Version

FLT990992

Rebuild/convert with kit #
FLT24256

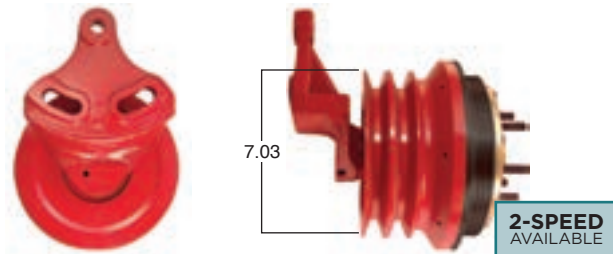

FLT99101

Fleetrite
Part Number

Rebuild with kit #
FLT14256

Or Convert to
2-Speed Version

FLT991012

Rebuild/convert with kit #
FLT24256

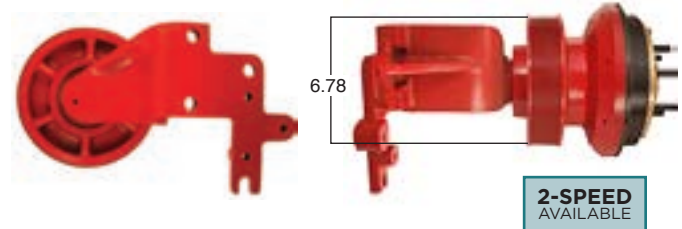

FLT99104

Fleetrite
Part Number

Rebuild with kit #
FLT14256

Or Convert to
2-Speed Version

FLT991042

Rebuild/convert with kit #
FLT24256

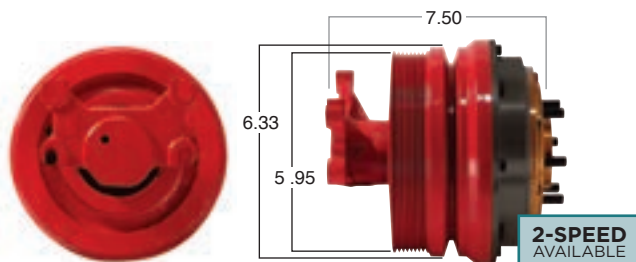

FLT99108

Fleetrite
Part Number

Rebuild with kit #
FLT14256

Or Convert to
2-Speed Version

FLT991082

Rebuild/convert with kit #
FLT24256

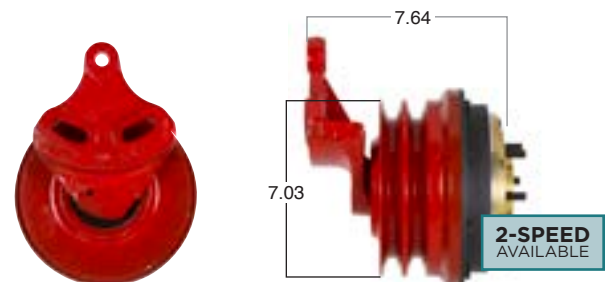

FLT99110 Fleetrite Part Number Rebuild with kit # FLT14256
 Or Convert to 2-Speed Version ▶ **FLT991102** Rebuild/convert with kit # FLT24256

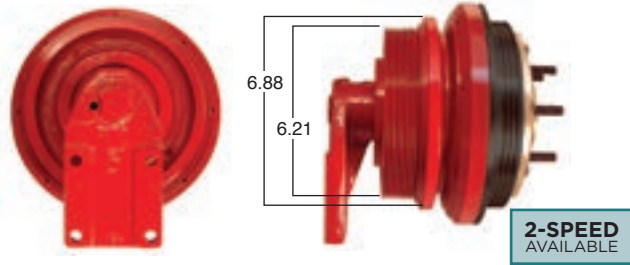

FLT99111 Fleetrite Part Number Rebuild with kit # FLT14256
 Or Convert to 2-Speed Version ▶ **FLT991112** Rebuild/convert with kit # FLT24256

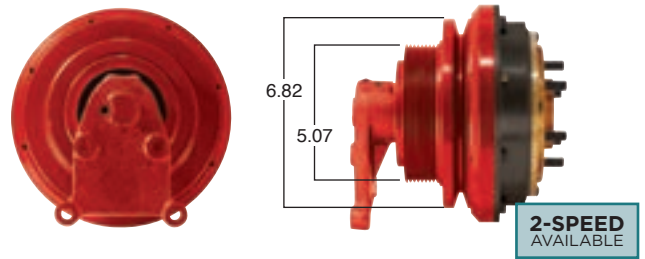

FLT99112 Fleetrite Part Number Rebuild with kit # FLT14256
 Or Convert to 2-Speed Version ▶ **FLT991122** Rebuild/convert with kit # FLT24256

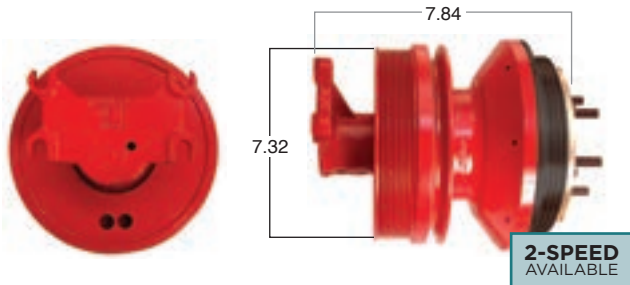

FLT99113 Fleetrite Part Number Rebuild with kit # FLT14256
 Or Convert to 2-Speed Version ▶ **FLT991132** Rebuild/convert with kit # FLT24256

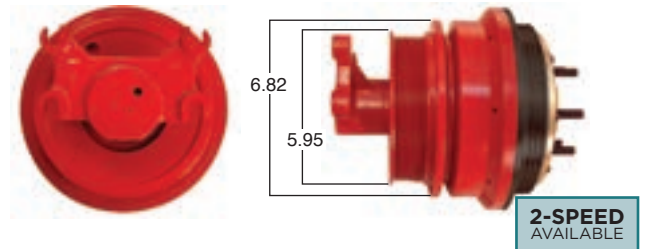

FLT99114 Fleetrite Part Number Rebuild with kit # FLT14256
 Or Convert to 2-Speed Version ▶ **FLT991142** Rebuild/convert with kit # FLT24256

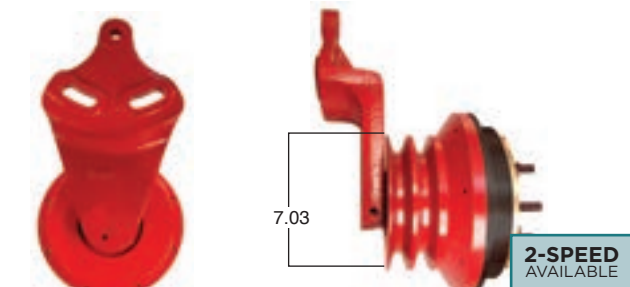

FLT99115 Fleetrite Part Number Rebuild with kit # FLT14256
 Or Convert to 2-Speed Version ▶ **FLT991152** Rebuild/convert with kit # FLT24256

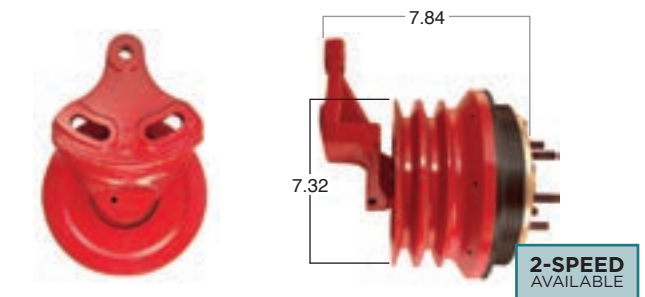

FLT99116 Fleetrite Part Number Rebuild with kit # FLT14256
 Or Convert to 2-Speed Version ▶ **FLT991162** Rebuild/convert with kit # FLT24256

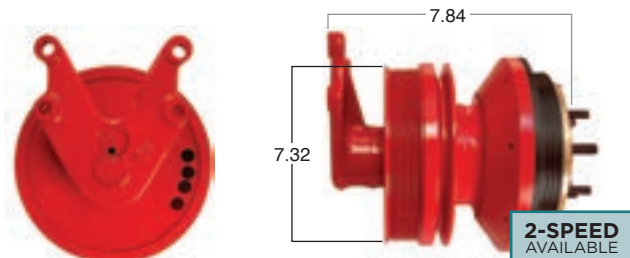

FLT99117 Fleetrite Part Number Rebuild with kit # FLT14256
 Or Convert to 2-Speed Version ▶ **FLT991172** Rebuild/convert with kit # FLT24256

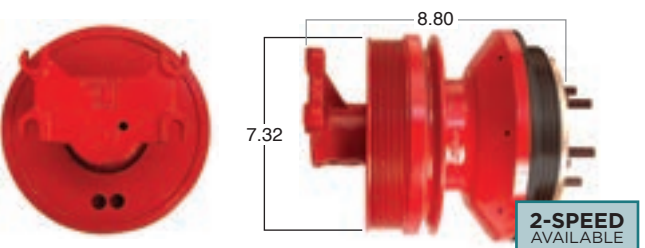

FLT99118

Fleetrite
Part Number

Rebuild with kit #
FLT14256

Or Convert to
2-Speed Version

FLT991182

Rebuild/convert with kit #
FLT24256

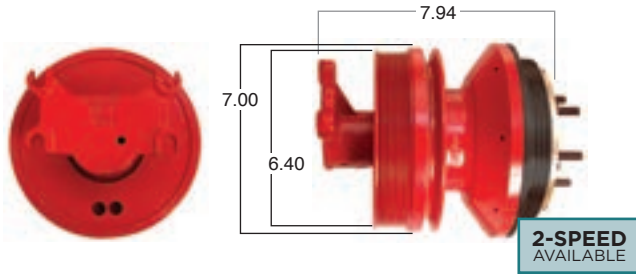

FLT99124

Fleetrite
Part Number

Rebuild with kit #
FLT14256

Or Convert to
2-Speed Version

FLT991242

Rebuild/convert with kit #
FLT24256

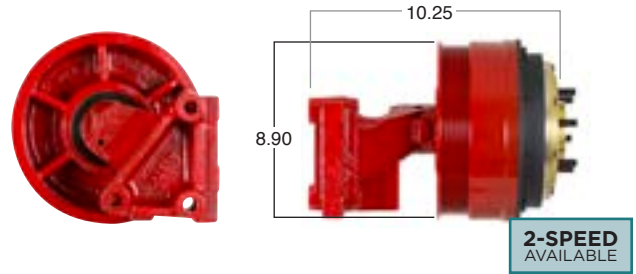

FLT99125

Fleetrite
Part Number

Rebuild with kit #
FLT142561

Or Convert to
2-Speed Version

FLT991252

Rebuild/convert with kit #
FLT242561

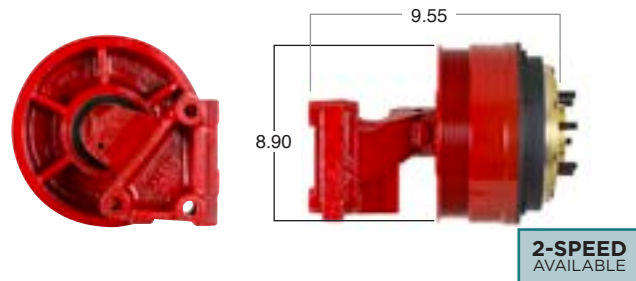

FLT99126

Fleetrite
Part Number

Rebuild with kit #
FLT14256

Or Convert to
2-Speed Version

FLT991262

Rebuild/convert with kit #
FLT24256

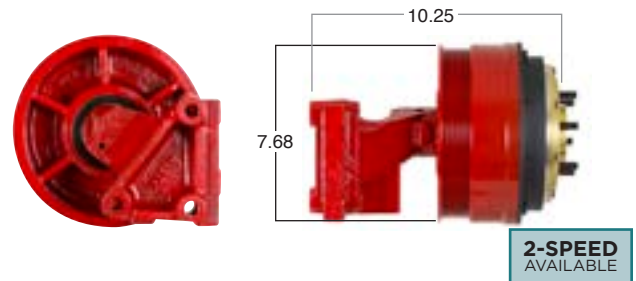

FLT99127

Fleetrite
Part Number

Rebuild with kit #
FLT14256

Or Convert to
2-Speed Version

FLT991272

Rebuild/convert with kit #
FLT24256

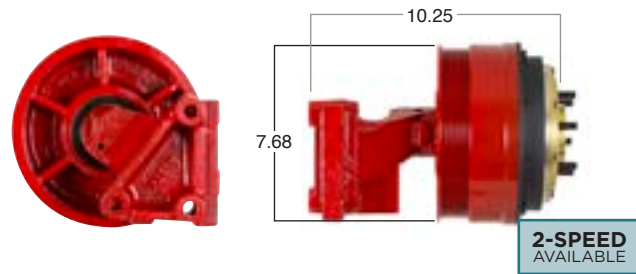

FLT99128

Fleetrite
Part Number

Rebuild with kit #
FLT14256

Or Convert to
2-Speed Version

FLT991282

Rebuild/convert with kit #
FLT24256

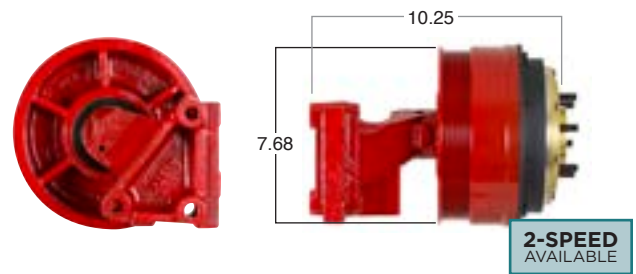

FLT99129

Fleetrite
Part Number

Rebuild with kit #
FLT14256

Or Convert to
2-Speed Version

FLT991292

Rebuild/convert with kit #
FLT24256

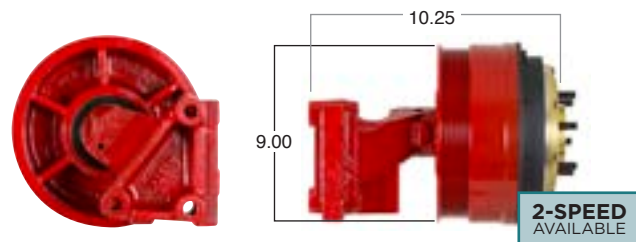

FLT99130

Fleetrite
Part Number

Rebuild with kit #
FLT14256

Or Convert to
2-Speed Version

FLT991302

Rebuild/convert with kit #
FLT24256

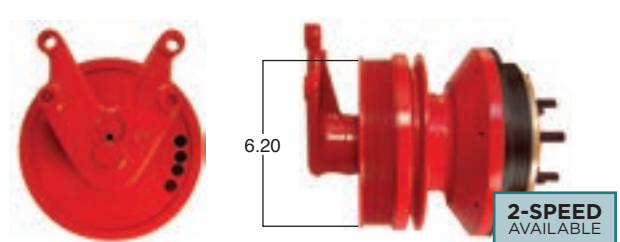

FLT99131 Fleetrite Part Number Rebuild with kit # FLT14256
 Or Convert to 2-Speed Version ▶ **FLT991312** Rebuild/convert with kit # FLT24256

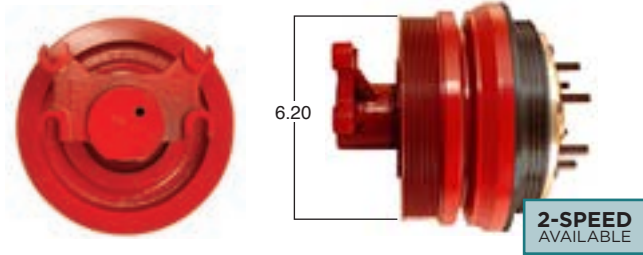

FLT99132 Fleetrite Part Number Rebuild with kit # FLT14256
 Or Convert to 2-Speed Version ▶ **FLT991322** Rebuild/convert with kit # FLT24256

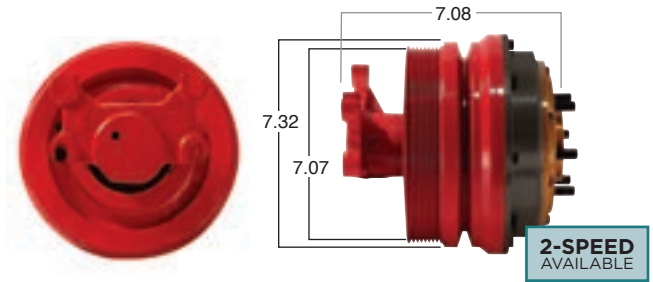

FLT99133 Fleetrite Part Number Rebuild with kit # FLT14256
 Or Convert to 2-Speed Version ▶ **FLT991332** Rebuild/convert with kit # FLT24256

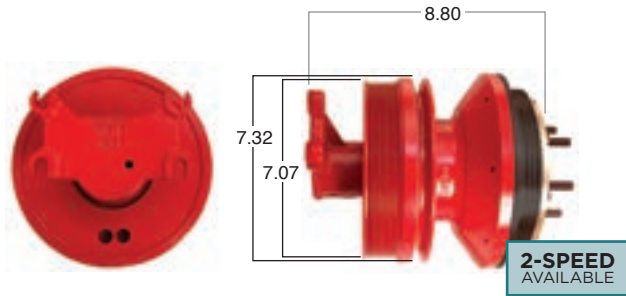

FLT99134 Fleetrite Part Number Rebuild with kit # FLT14256
 Or Convert to 2-Speed Version ▶ **FLT991342** Rebuild/convert with kit # FLT24256

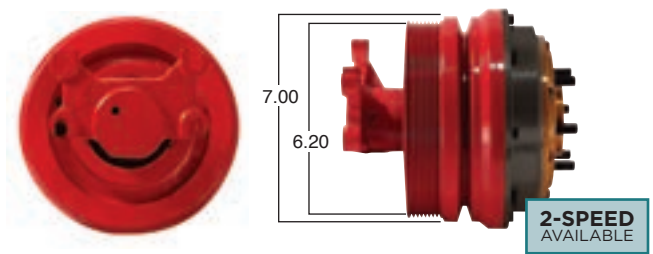

FLT99150 Fleetrite Part Number Rebuild with kit # FLT14256
 Or Convert to 2-Speed Version ▶ **FLT991502** Rebuild/convert with kit # FLT24256

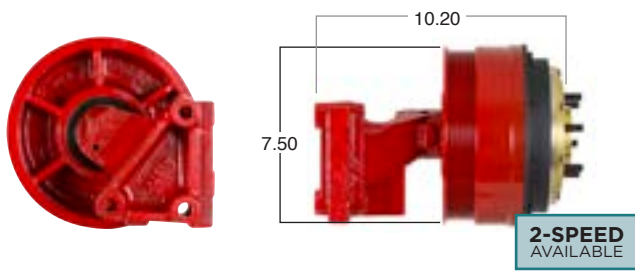

FLT99153 Fleetrite Part Number Rebuild with kit # FLT14200
 Or Convert to 2-Speed Version ▶ **FLT991532** Rebuild/convert with kit # FLT24200

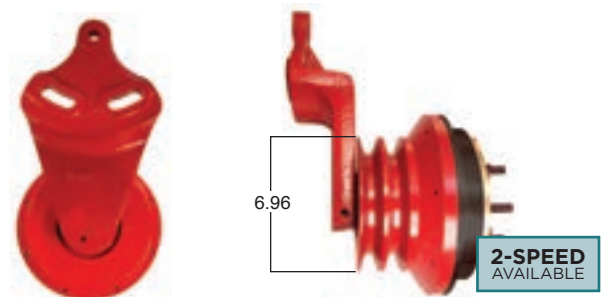

FLT99154 Fleetrite Part Number Rebuild with kit # FLT14256
 Or Convert to 2-Speed Version ▶ **FLT991542** Rebuild/convert with kit # FLT24256

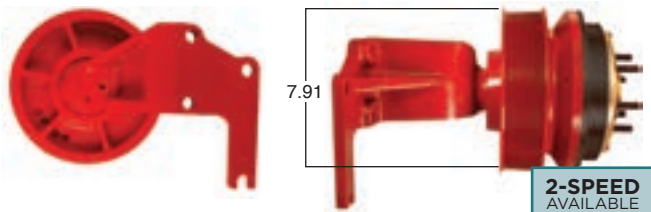

FLT99167 Fleetrite Part Number Rebuild with kit # FLT14256
 Or Convert to 2-Speed Version ▶ **FLT991672** Rebuild/convert with kit # FLT24256

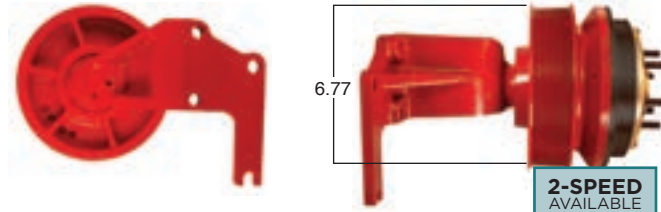

FLT99168

Fleetrite
Part Number

Rebuild with kit #
FLT14256

Or Convert to
2-Speed Version

FLT991682

Rebuild/convert with kit #
FLT24256

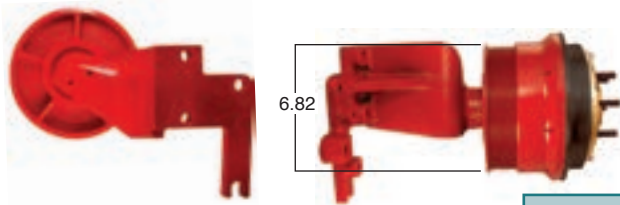

**2-SPEED
AVAILABLE**

FLT99169

Fleetrite
Part Number

Rebuild with kit #
FLT14256

Or Convert to
2-Speed Version

FLT991692

Rebuild/convert with kit #
FLT24256

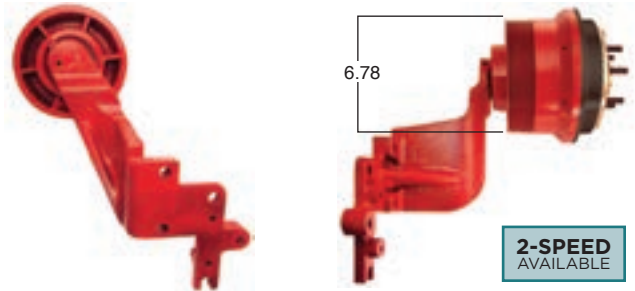

**2-SPEED
AVAILABLE**

FLT99170

Fleetrite
Part Number

Rebuild with kit #
FLT14256

Or Convert to
2-Speed Version

FLT991702

Rebuild/convert with kit #
FLT24256

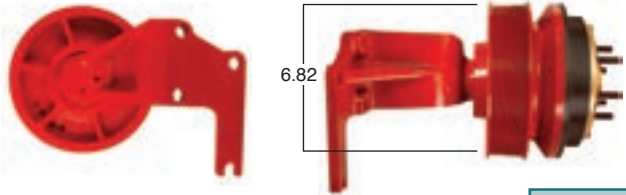

**2-SPEED
AVAILABLE**

FLT99171

Fleetrite
Part Number

Rebuild with kit #
FLT14256

Or Convert to
2-Speed Version

FLT991712

Rebuild/convert with kit #
FLT24256

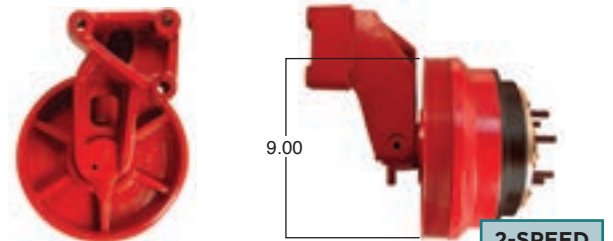

**2-SPEED
AVAILABLE**

FLT99172

Fleetrite
Part Number

Rebuild with kit #
FLT14256

Or Convert to
2-Speed Version

FLT991722

Rebuild/convert with kit #
FLT24256

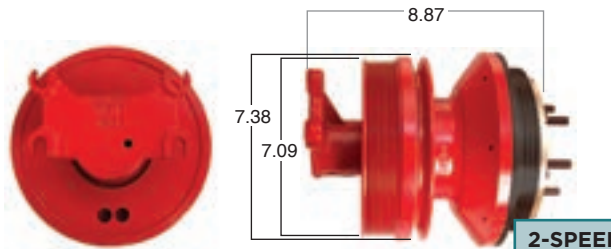

**2-SPEED
AVAILABLE**

FLT99174

Fleetrite
Part Number

Rebuild with kit #
FLT14256

Or Convert to
2-Speed Version

FLT991742

Rebuild/convert with kit #
FLT24256

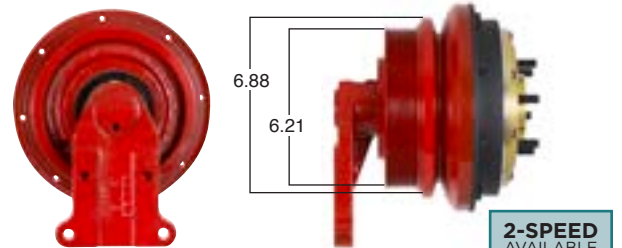

**2-SPEED
AVAILABLE**

FLT99175

Fleetrite
Part Number

Rebuild with kit #
FLT14256

Or Convert to
2-Speed Version

FLT991752

Rebuild/convert with kit #
FLT24256

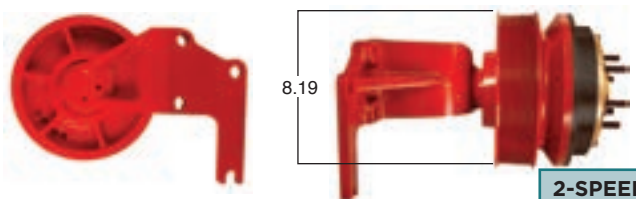

**2-SPEED
AVAILABLE**

FLT99188

Fleetrite
Part Number

Rebuild with kit #
FLT14256

Or Convert to
2-Speed Version

FLT991882

Rebuild/convert with kit #
FLT24256

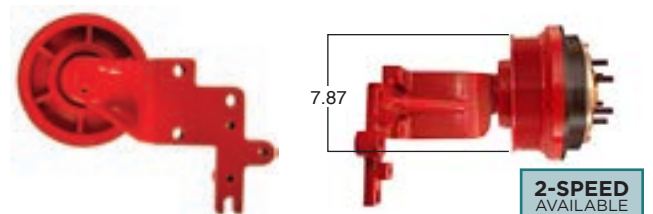

**2-SPEED
AVAILABLE**

FLT99198 Fleetrite Part Number Rebuild with kit # FLT14256
 Or Convert to 2-Speed Version ▶ **FLT991982** Rebuild/convert with kit # FLT24256

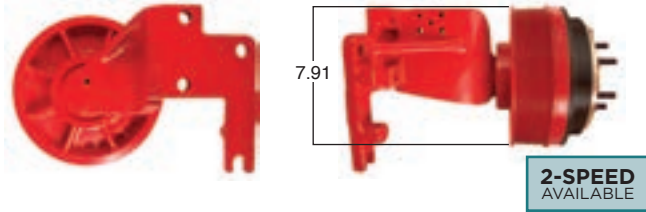

FLT99201 Fleetrite Part Number Rebuild with kit # FLT14200
 Or Convert to 2-Speed Version ▶ **FLT992012** Rebuild/convert with kit # FLT24200

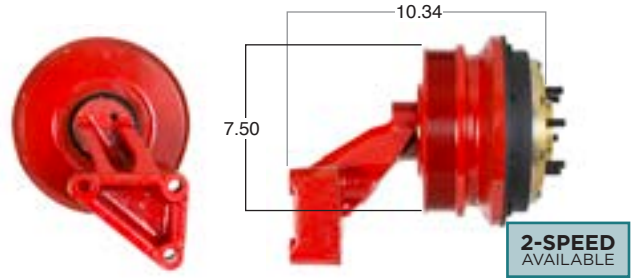

FLT99205 Fleetrite Part Number Rebuild with kit # FLT14256
 Or Convert to 2-Speed Version ▶ **FLT992052** Rebuild/convert with kit # FLT24256

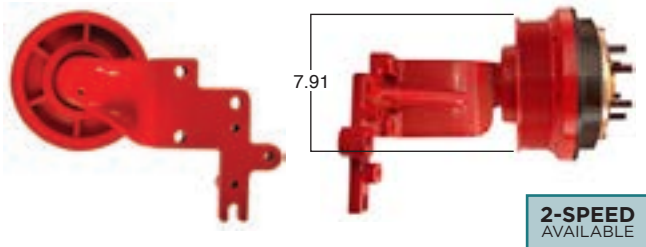

FLT99207 Fleetrite Part Number Rebuild with kit # FLT14256
 Or Convert to 2-Speed Version ▶ **FLT992072** Rebuild/convert with kit # FLT24256

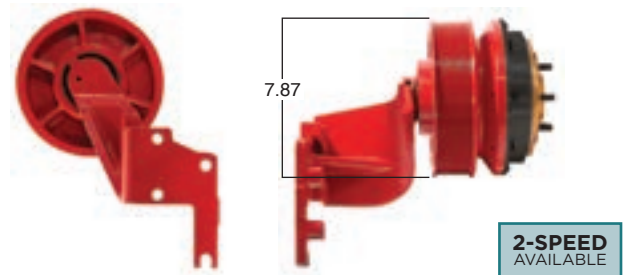

FLT99218 Fleetrite Part Number Rebuild with kit # FLT14256
 Or Convert to 2-Speed Version ▶ **FLT992182** Rebuild/convert with kit # FLT24256

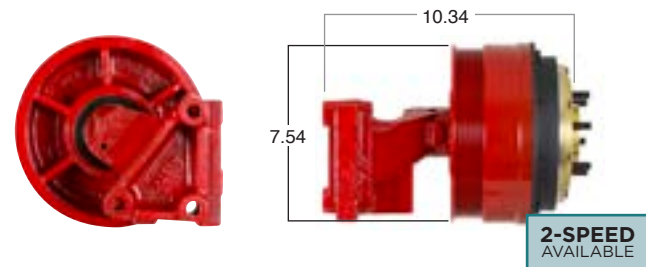

FLT99219 Fleetrite Part Number Rebuild with kit # FLT14256
 Or Convert to 2-Speed Version ▶ **FLT992192** Rebuild/convert with kit # FLT24256

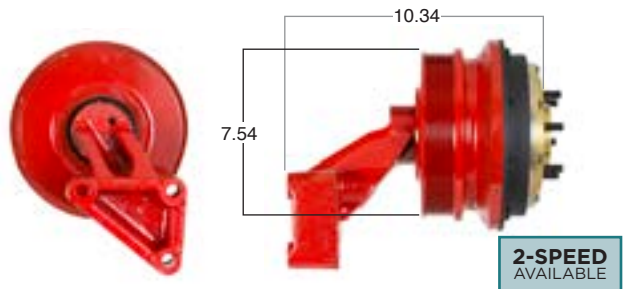

FLT99232 Fleetrite Part Number Rebuild with kit # FLT14256
 Or Convert to 2-Speed Version ▶ **FLT992322** Rebuild/convert with kit # FLT24256

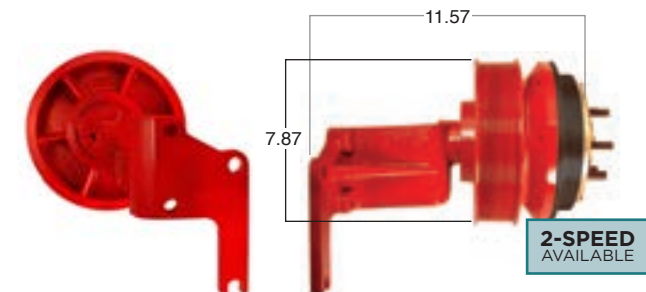

FLT99233 Fleetrite Part Number Rebuild with kit # FLT142561
 Or Convert to 2-Speed Version ▶ **FLT992332** Rebuild/convert with kit # FLT242561

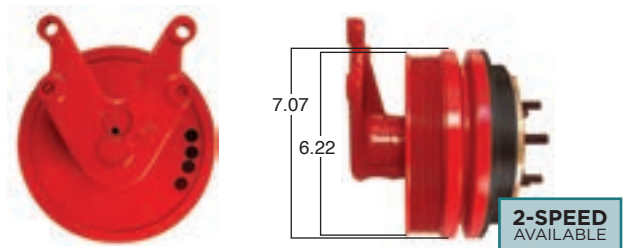

FLT99238

Fleetrite
Part Number

Rebuild with kit #
FLT14256

Or Convert to
2-Speed Version

FLT992382

Rebuild/convert with kit #
FLT24256

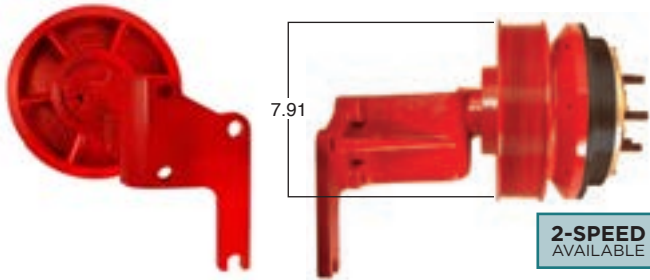

FLT99242

Fleetrite
Part Number

Rebuild with kit #
FLT14256

Or Convert to
2-Speed Version

FLT992422

Rebuild/convert with kit #
FLT24256

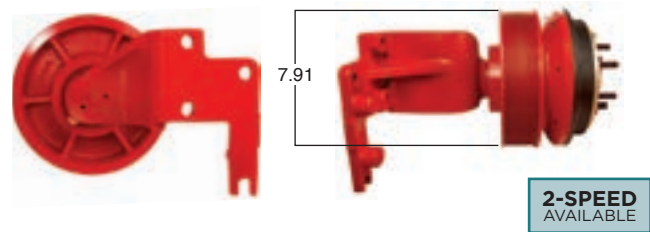

FLT99246

Fleetrite
Part Number

Rebuild with kit #
FLT14256

Or Convert to
2-Speed Version

FLT992462

Rebuild/convert with kit #
FLT24256

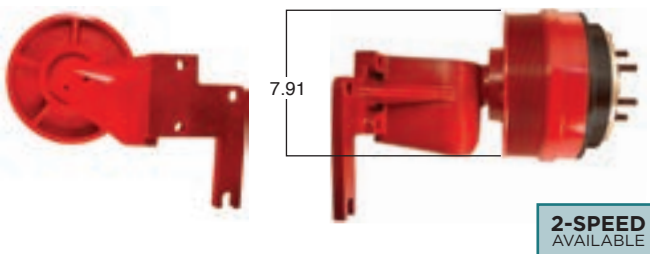

FLT99248

Fleetrite
Part Number

Rebuild with kit #
FLT142561

Or Convert to
2-Speed Version

FLT992482

Rebuild/convert with kit #
FLT242561

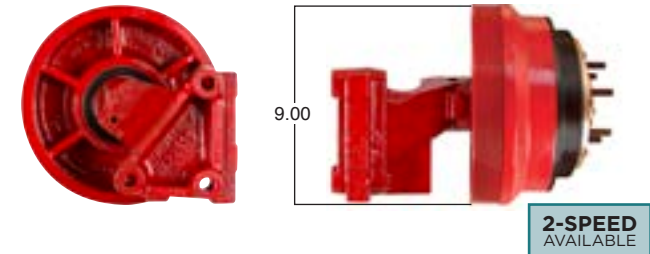

FLT99253

Fleetrite
Part Number

Rebuild with kit #
FLT14256

Or Convert to
2-Speed Version

FLT992532

Rebuild/convert with kit #
FLT24256

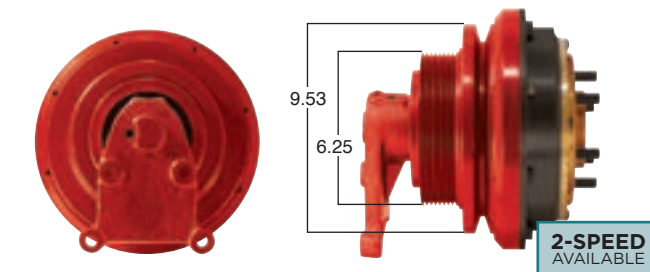

FLT99259

Fleetrite
Part Number

Rebuild with kit #
FLT142561

Or Convert to
2-Speed Version

FLT992592

Rebuild/convert with kit #
FLT242561

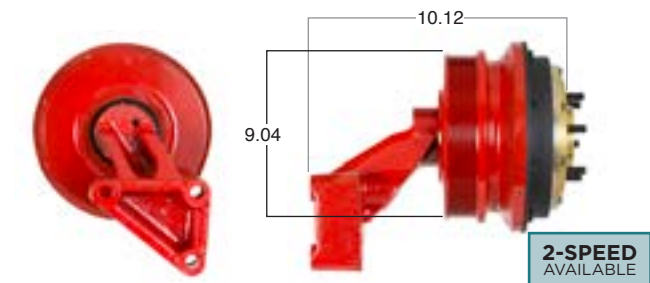

FLT99263

Fleetrite
Part Number

Rebuild with kit #
FLT14256

Or Convert to
2-Speed Version

FLT992632

Rebuild/convert with kit #
FLT24256

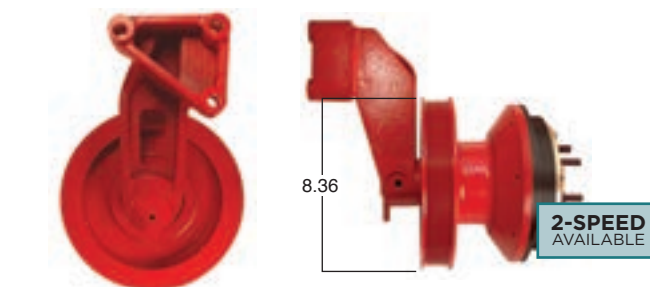

FLT99264

Fleetrite
Part Number

Rebuild with kit #
FLT14256

Or Convert to
2-Speed Version

FLT992642

Rebuild/convert with kit #
FLT24256

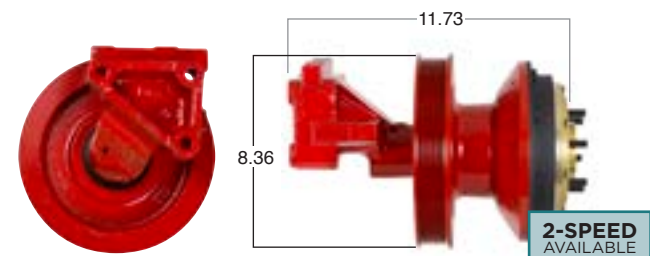

FLT99277 Fleetrite Part Number Rebuild with kit # FLT14256

Or Convert to 2-Speed Version ▶ **FLT992772** Rebuild/convert with kit # FLT24256

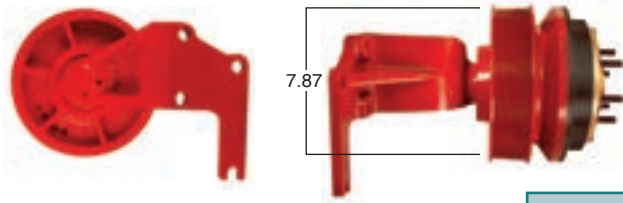

2-SPEED AVAILABLE

FLT99278 Fleetrite Part Number Rebuild with kit # FLT14256

Or Convert to 2-Speed Version ▶ **FLT992782** Rebuild/convert with kit # FLT24256

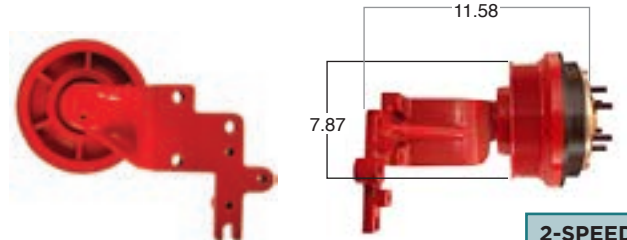

2-SPEED AVAILABLE

FLT99282 Fleetrite Part Number Rebuild with kit # FLT142561

Or Convert to 2-Speed Version ▶ **FLT992822** Rebuild/convert with kit # FLT242561

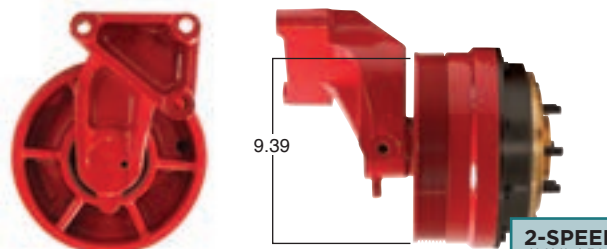

2-SPEED AVAILABLE

FLT99283 Fleetrite Part Number Rebuild with kit # FLT14256

Or Convert to 2-Speed Version ▶ **FLT992832** Rebuild/convert with kit # FLT24256

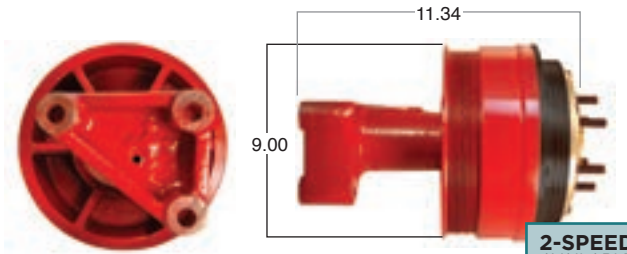

2-SPEED AVAILABLE

FLT99295 Fleetrite Part Number Rebuild with kit # FLT14256

Or Convert to 2-Speed Version ▶ **FLT992952** Rebuild/convert with kit # FLT24256

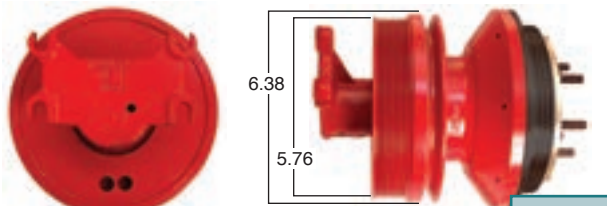

2-SPEED AVAILABLE

FLT99296 Fleetrite Part Number Rebuild with kit # FLT14256

Or Convert to 2-Speed Version ▶ **FLT992962** Rebuild/convert with kit # FLT24256

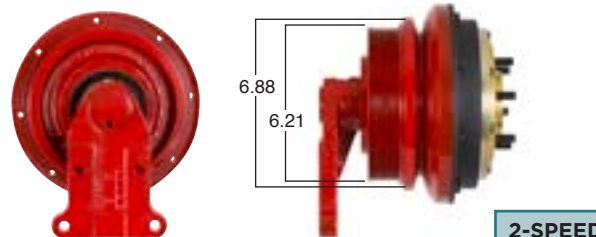

2-SPEED AVAILABLE

FLT99297 Fleetrite Part Number Rebuild with kit # FLT14256

Or Convert to 2-Speed Version ▶ **FLT992972** Rebuild/convert with kit # FLT24256

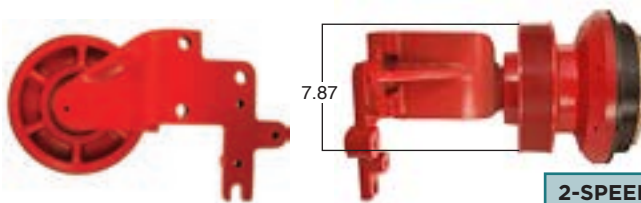

2-SPEED AVAILABLE

FLT99306 Fleetrite Part Number Rebuild with kit # FLT14256

Or Convert to 2-Speed Version ▶ **FLT993062** Rebuild/convert with kit # FLT24256

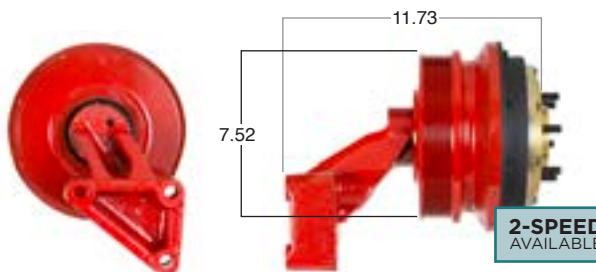

2-SPEED AVAILABLE

FLT99309

Fleetrite
Part Number

Rebuild with kit #
FLT14256

Or Convert to
2-Speed Version

FLT993092

Rebuild/convert with kit #
FLT24256

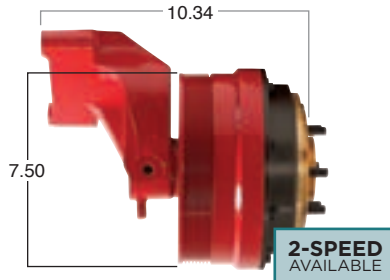

FLT99310

Fleetrite
Part Number

Rebuild with kit #
FLT142561

Or Convert to
2-Speed Version

FLT993102

Rebuild/convert with kit #
FLT242561

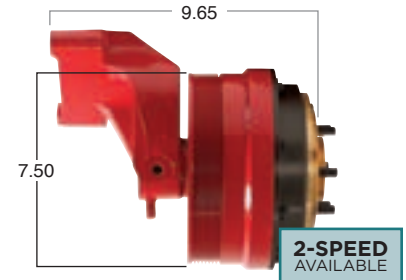

FLT99324

Fleetrite
Part Number

Rebuild with kit #
FLT14256

Or Convert to
2-Speed Version

FLT993242

Rebuild/convert with kit #
FLT24256

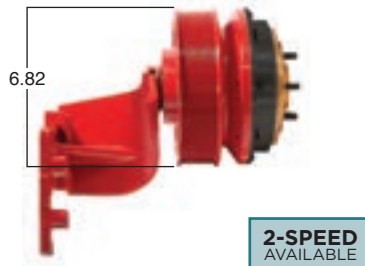

FLT99325

Fleetrite
Part Number

Rebuild with kit #
FLT14256

Or Convert to
2-Speed Version

FLT993252

Rebuild/convert with kit #
FLT24256

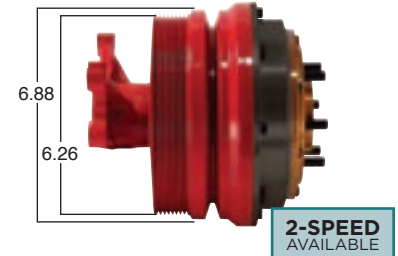

FLT99326

Fleetrite
Part Number

Rebuild with kit #
FLT14256

Or Convert to
2-Speed Version

FLT993262

Rebuild/convert with kit #
FLT24256

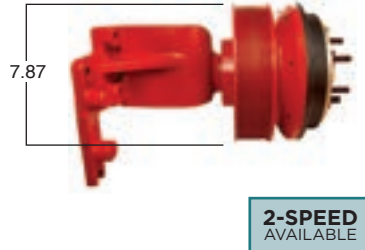

FLT99331

Fleetrite
Part Number

Rebuild with kit #
FLT14256

Or Convert to
2-Speed Version

FLT993312

Rebuild/convert with kit #
FLT24256

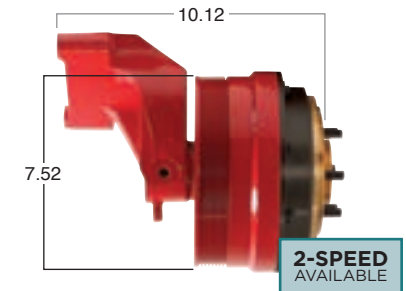

FLT99343

Fleetrite
Part Number

Rebuild with kit #
FLT14256

Or Convert to
2-Speed Version

FLT993432

Rebuild/convert with kit #
FLT24256

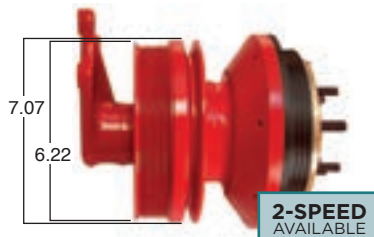

FLT99349

Fleetrite
Part Number

Rebuild with kit #
FLT14256

Or Convert to
2-Speed Version

FLT993492

Rebuild/convert with kit #
FLT24256

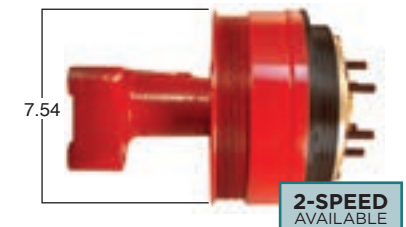

FLT99350 Fleetrite Part Number Rebuild with kit # FLT14256
 Or Convert to 2-Speed Version ▶ **FLT993502** Rebuild/convert with kit # FLT24256

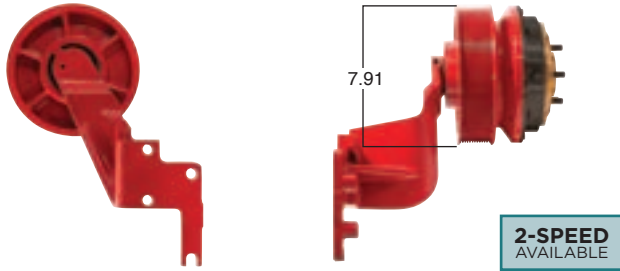

FLT99352 Fleetrite Part Number Rebuild with kit # FLT14256
 Or Convert to 2-Speed Version ▶ **FLT993522** Rebuild/convert with kit # FLT24256

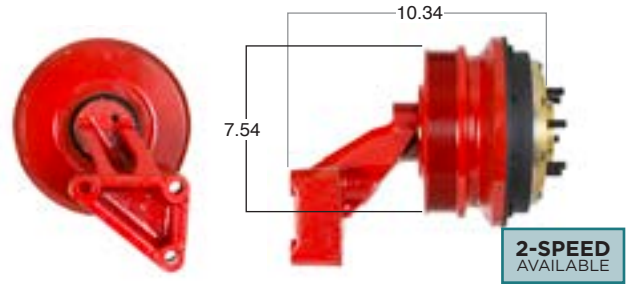

FLT99365 Fleetrite Part Number Rebuild with kit # FLT14256
 Or Convert to 2-Speed Version ▶ **FLT993652** Rebuild/convert with kit # FLT24256

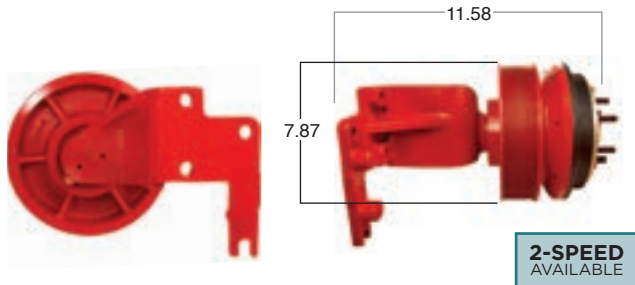

FLT99384 Fleetrite Part Number Rebuild with kit # FLT14256
 Or Convert to 2-Speed Version ▶ **FLT993842** Rebuild/convert with kit # FLT24256

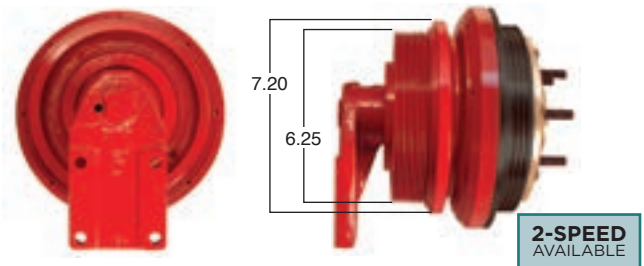

FLT99389 Fleetrite Part Number Rebuild with kit # FLT14256
 Or Convert to 2-Speed Version ▶ **FLT993892** Rebuild/convert with kit # FLT24256

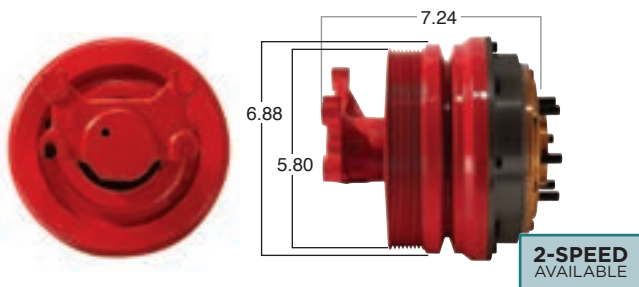

FLT99415 Fleetrite Part Number Rebuild with kit # FLT14256
 Or Convert to 2-Speed Version ▶ **FLT994152** Rebuild/convert with kit # FLT24256

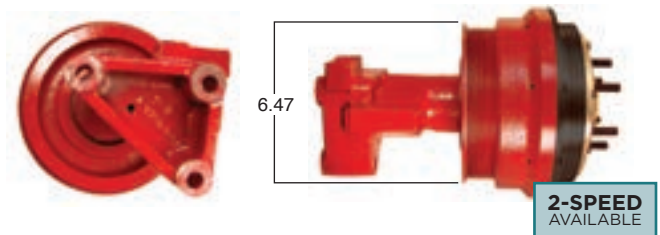

FLT99430 Fleetrite Part Number Rebuild with kit # FLT14256
 Or Convert to 2-Speed Version ▶ **FLT994302** Rebuild/convert with kit # FLT24256

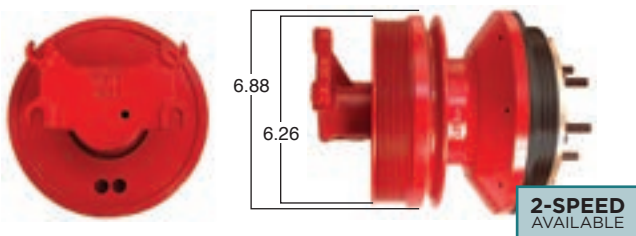

FLT99446 Fleetrite Part Number Rebuild with kit # FLT14256
 Or Convert to 2-Speed Version ▶ **FLT994462** Rebuild/convert with kit # FLT24256

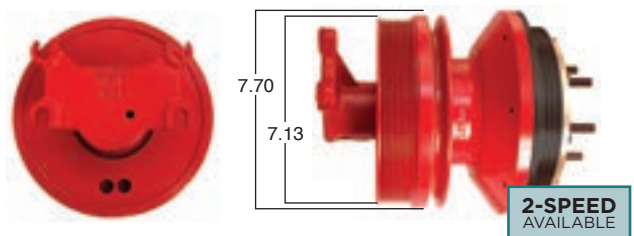

FLT99466

Fleetrite
Part Number

Rebuild with kit #
FLT14256

Or Convert to
2-Speed Version

FLT994662

Rebuild/convert with kit #
FLT24256



**2-SPEED
AVAILABLE**

FLT99509

Fleetrite
Part Number

Rebuild with kit #
FLT14256

Or Convert to
2-Speed Version

FLT995092

Rebuild/convert with kit #
FLT24256

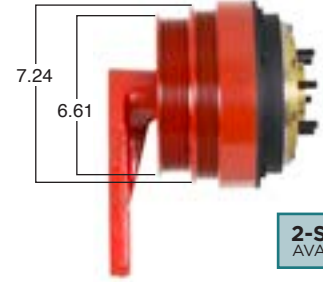

**2-SPEED
AVAILABLE**

FLT99537

Fleetrite
Part Number

Rebuild with kit #
FLT14256

Or Convert to
2-Speed Version

FLT995372

Rebuild/convert with kit #
FLT24256

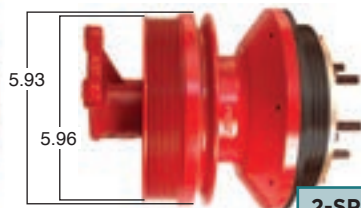

**2-SPEED
AVAILABLE**

FLT99542

Fleetrite
Part Number

Rebuild with kit #
FLT14256

Or Convert to
2-Speed Version

FLT995422

Rebuild/convert with kit #
FLT24256

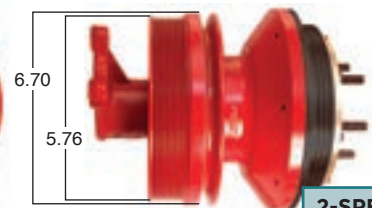

**2-SPEED
AVAILABLE**

FLT99548

Fleetrite
Part Number

Rebuild with kit #
FLT14256

Or Convert to
2-Speed Version

FLT995482

Rebuild/convert with kit #
FLT24256

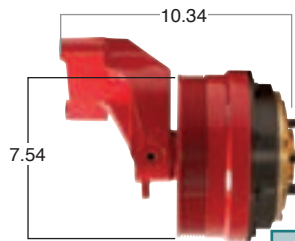

**2-SPEED
AVAILABLE**

FLT99612

Fleetrite
Part Number

Rebuild with kit #
FLT14256

Or Convert to
2-Speed Version

FLT996122

Rebuild/convert with kit #
FLT24256

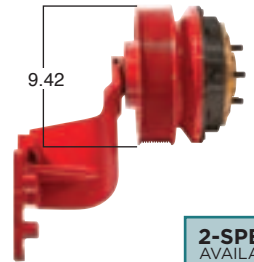

**2-SPEED
AVAILABLE**

FLT99630

Fleetrite
Part Number

Rebuild with kit #
FLT14256

Or Convert to
2-Speed Version

FLT996302

Rebuild/convert with kit #
FLT24256

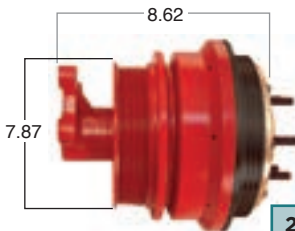

**2-SPEED
AVAILABLE**

FLT99632

Fleetrite
Part Number

Rebuild with kit #
FLT14256

Or Convert to
2-Speed Version

FLT996322

Rebuild/convert with kit #
FLT24256

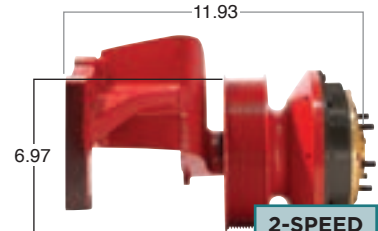
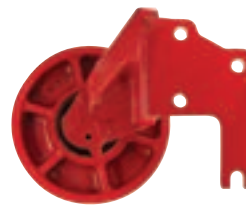

**2-SPEED
AVAILABLE**

FLT99663 Fleetrite Part Number Rebuild with kit # FLT14256

Or Convert to 2-Speed Version ▶ **FLT996632** Rebuild/convert with kit # FLT24256

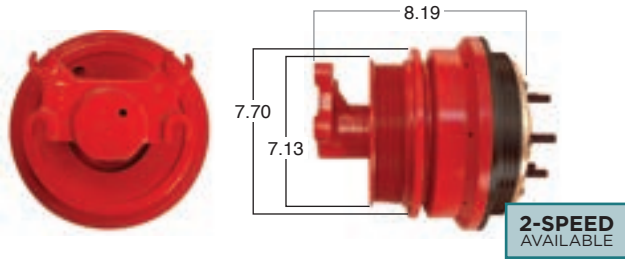

FLT99800 Fleetrite Part Number Rebuild with kit # FLT14256

Or Convert to 2-Speed Version ▶ **FLT998002** Rebuild/convert with kit # FLT24256

10 groove pulley

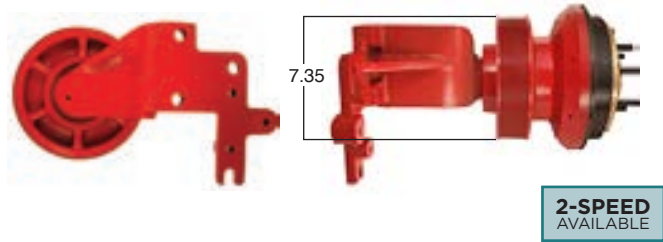

FLT99801 Fleetrite Part Number Rebuild with kit # FLT14256

Or Convert to 2-Speed Version ▶ **FLT998012** Rebuild/convert with kit # FLT24256

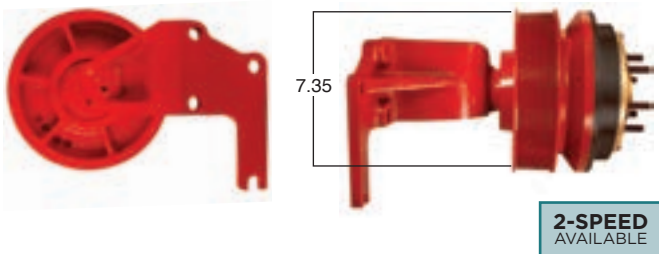

FLT99802 Fleetrite Part Number Rebuild with kit # FLT14256

Or Convert to 2-Speed Version ▶ **FLT998022** Rebuild/convert with kit # FLT24256

12 groove pulley

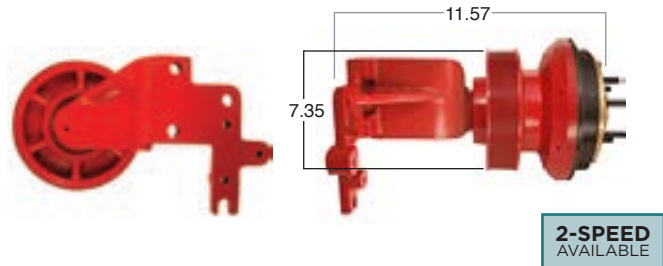

FLT99803 Fleetrite Part Number Rebuild with kit # FLT14256

Or Convert to 2-Speed Version ▶ **FLT998032** Rebuild/convert with kit # FLT24256

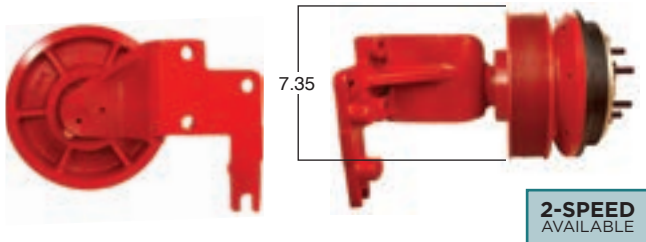

FLT99807 Fleetrite Part Number Rebuild with kit # FLT142561

Or Convert to 2-Speed Version ▶ **FLT998072** Rebuild/convert with kit # FLT242561

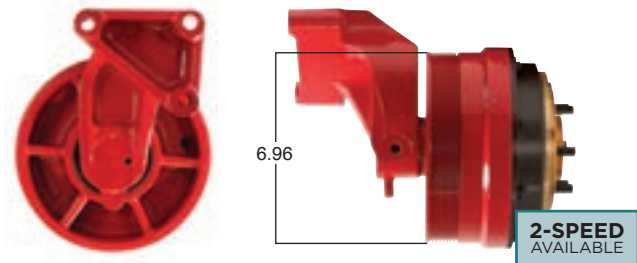

FLT99822 Fleetrite Part Number Rebuild with kit # FLT14256

Or Convert to 2-Speed Version ▶ **FLT998222** Rebuild/convert with kit # FLT24256

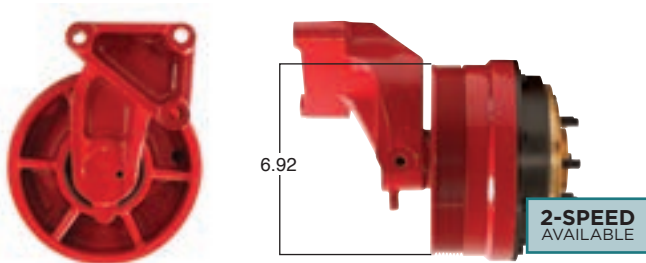

FLT99823 Fleetrite Part Number Rebuild with kit # FLT14256

Or Convert to 2-Speed Version ▶ **FLT998232** Rebuild/convert with kit # FLT24256

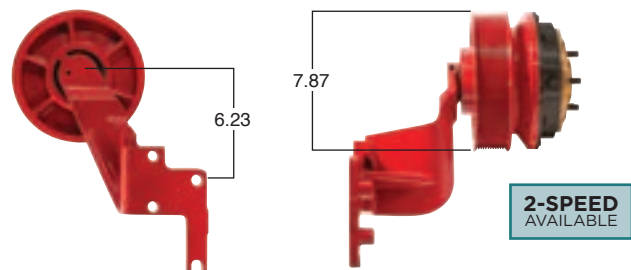

FLT99824

Fleetrite Part Number

Rebuild with kit # FLT14256

Or Convert to 2-Speed Version

FLT998242

Rebuild/convert with kit # FLT24256

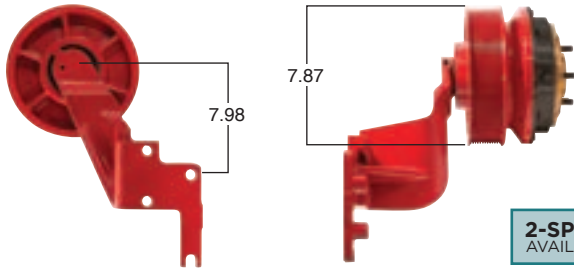

2-SPEED AVAILABLE

FLT99840

Fleetrite Part Number

Rebuild with kit # FLT14256

Or Convert to 2-Speed Version

FLT998402

Rebuild/convert with kit # FLT24256

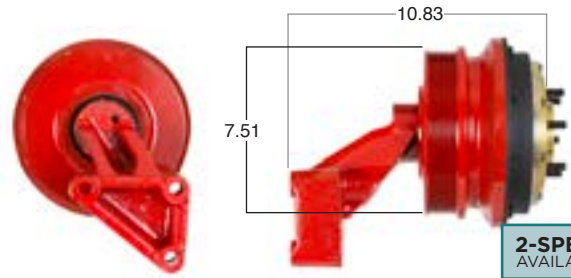

2-SPEED AVAILABLE

FLT99842

Fleetrite Part Number

Rebuild with kit # FLT14256

Or Convert to 2-Speed Version

FLT998422

Rebuild/convert with kit # FLT24256

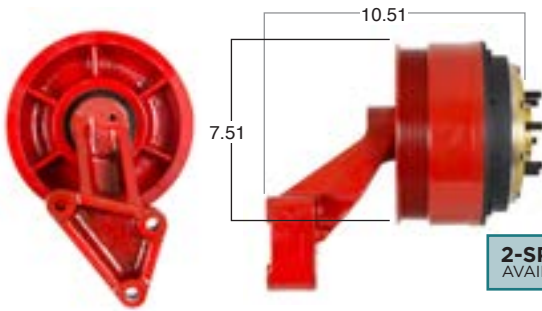

2-SPEED AVAILABLE

FLT99845

Fleetrite Part Number

Rebuild with kit # FLT14256

Or Convert to 2-Speed Version

FLT998452

Rebuild/convert with kit # FLT24256

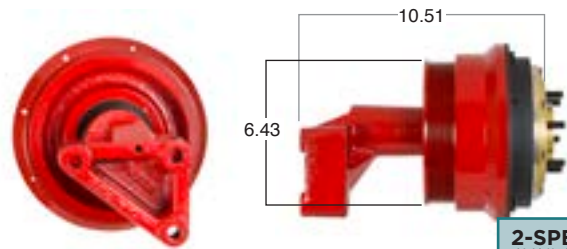

2-SPEED AVAILABLE

FLT99847

Fleetrite Part Number

Rebuild with kit # FLT14256

Or Convert to 2-Speed Version

FLT998472

Rebuild/convert with kit # FLT24256

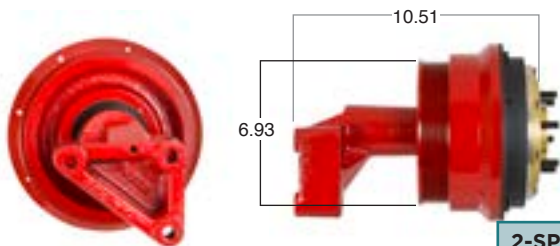

2-SPEED AVAILABLE

FLT99864

Fleetrite Part Number

Rebuild with kit # FLT14256

Or Convert to 2-Speed Version

FLT998642

Rebuild/convert with kit # FLT24256

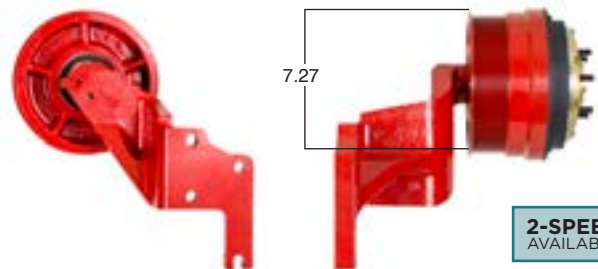

2-SPEED AVAILABLE

FLT99865

Fleetrite Part Number

Rebuild with kit # FLT14256

Or Convert to 2-Speed Version

FLT998652

Rebuild/convert with kit # FLT24256

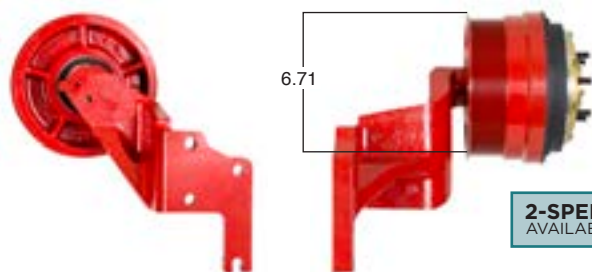

2-SPEED AVAILABLE

FLT99868

Fleetrite Part Number

Rebuild with kit # FLT14256

Or Convert to 2-Speed Version

FLT998682

Rebuild/convert with kit # FLT24256

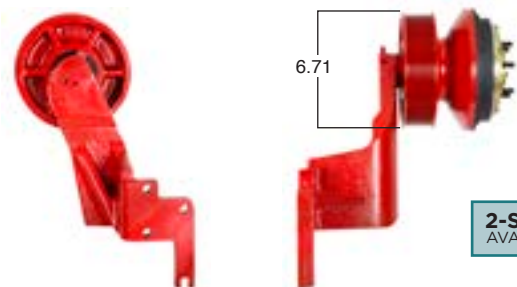

2-SPEED AVAILABLE

FLT99870 Fleetrite Part Number Rebuild with kit # FLT14256

Or Convert to 2-Speed Version ▶ **FLT998702** Rebuild/convert with kit # FLT24256

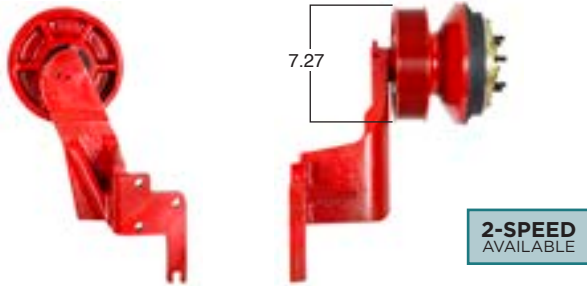

FLT99871 Fleetrite Part Number Rebuild with kit # FLT14256

Or Convert to 2-Speed Version ▶ **FLT998712** Rebuild/convert with kit # FLT24256

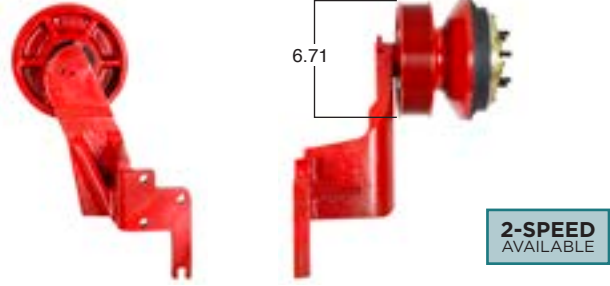

FLT99885 Fleetrite Part Number Rebuild with kit # FLT14256

Or Convert to 2-Speed Version ▶ **FLT998852** Rebuild/convert with kit # FLT24256

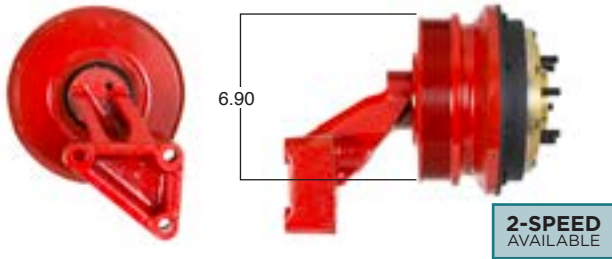

FLT99887 Fleetrite Part Number Rebuild with kit # FLT14256

Or Convert to 2-Speed Version ▶ **FLT998872** Rebuild/convert with kit # FLT24256

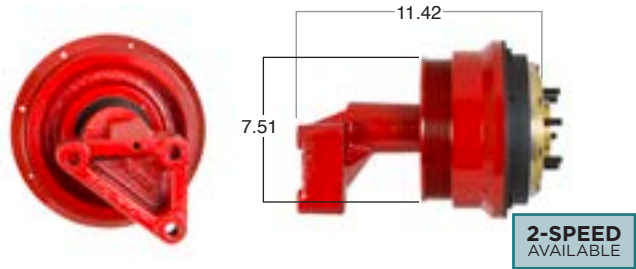

FLT99897 Fleetrite Part Number Rebuild with kit # FLT14256

Or Convert to 2-Speed Version ▶ **FLT998972** Rebuild/convert with kit # FLT24256

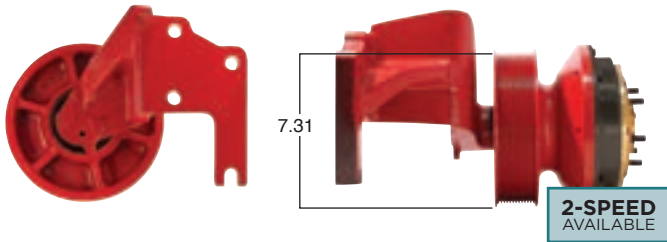

FLT90003 Fleetrite Part Number

Rebuild with kit # **FLT7500HP**

7.5" Friction Plate

2.05" Fan Pilot

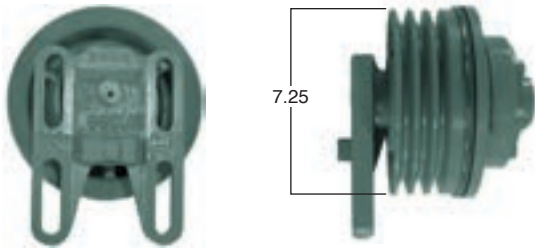

FLT90004 Fleetrite Part Number

Rebuild with kit # **FLT7500HP**

7.5" Friction Plate

2.05" Fan Pilot

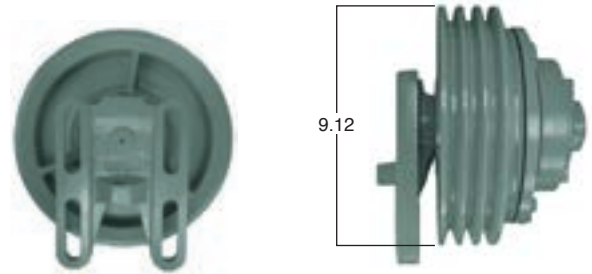

FLT90009 Fleetrite Part Number

Rebuild with kit # **FLT7500HP**

7.5" Friction Plate

2" Fan Pilot

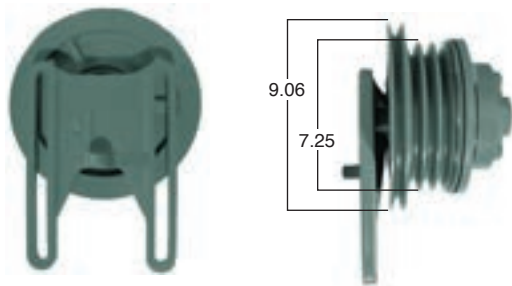

FLT90011 Fleetrite Part Number

Rebuild with kit # **FLT7500HP**

7.5" Friction Plate

2" Fan Pilot

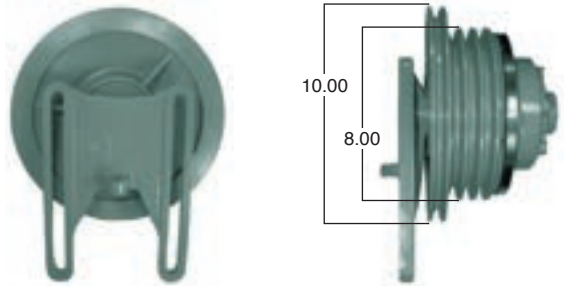

FLT90018 Fleetrite Part Number

Rebuild with kit # **FLT7500HP**

7.5" Friction Plate

2" Fan Pilot

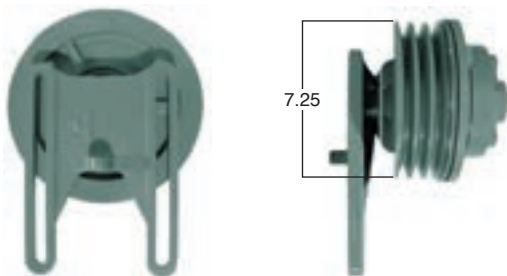

FLT90019 Fleetrite Part Number

Rebuild with kit # **FLT7500HP**

7.5" Friction Plate

2" Fan Pilot

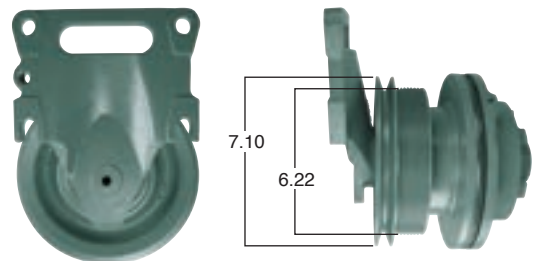

FLT90020 Fleetrite Part Number

Rebuild with kit # **FLT7500HP**

7.5" Friction Plate

2" Fan Pilot

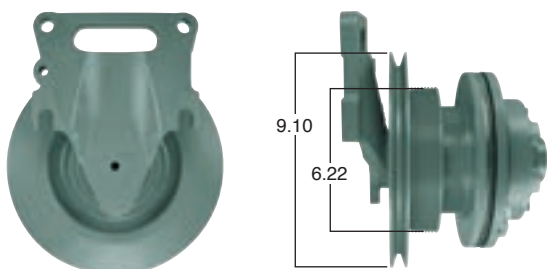

FLT90029 Fleetrite Part Number

Rebuild with kit # **FLT7500HP**

7.5" Friction Plate

2.05" Fan Pilot

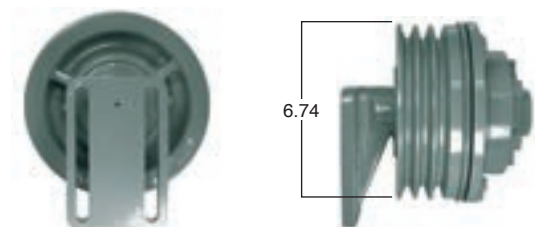

FLT91011

Fleetrite
Part Number

Rebuild with kit #
FLT9500HP

9.5" Friction Plate

2" Fan Pilot
Same as FLT91091

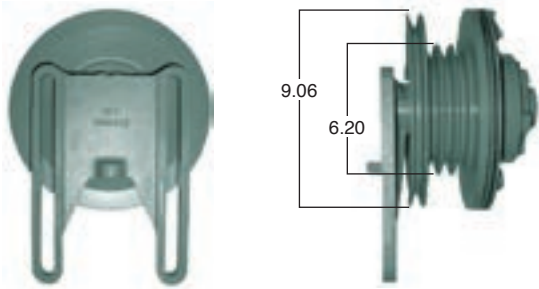

FLT91023

Fleetrite
Part Number

Rebuild with kit #
FLT9500HP

9.5" Friction Plate

5" Fan Pilot

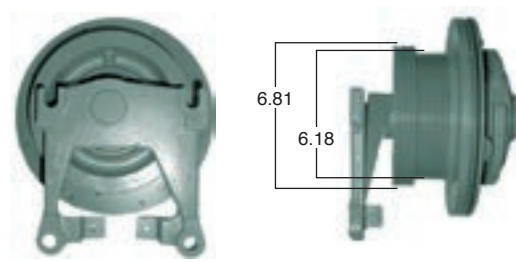

FLT91024

Fleetrite
Part Number

Rebuild with kit #
FLT9500HP

9.5" Friction Plate

2" Fan Pilot
Same as FLT91065

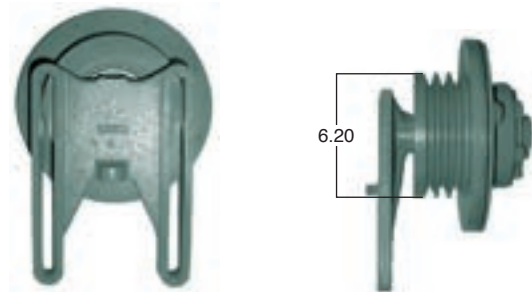

FLT91031

Fleetrite
Part Number

Rebuild with kit #
FLT9500HP

9.5" Friction Plate

5" Fan Pilot

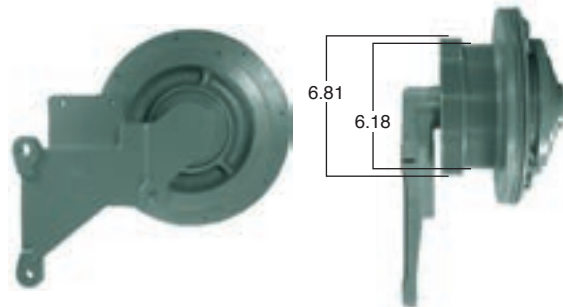

FLT91033

Fleetrite
Part Number

Rebuild with kit #
FLT9500HP

9.5" Friction Plate

2.56" Fan Pilot

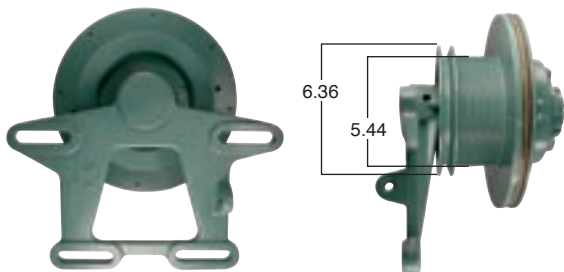

FLT91037

Fleetrite
Part Number

Rebuild with kit #
FLT9500HP

9.5" Friction Plate

2" Fan Pilot

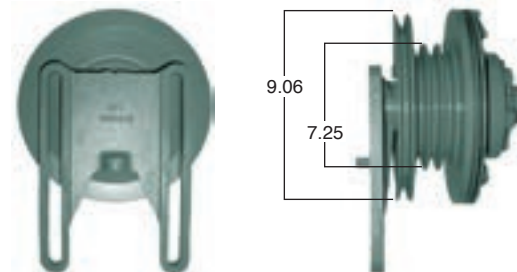

FLT91046

Fleetrite
Part Number

Rebuild with kit #
FLT9500HP

9.5" Friction Plate

2.56" Fan Pilot

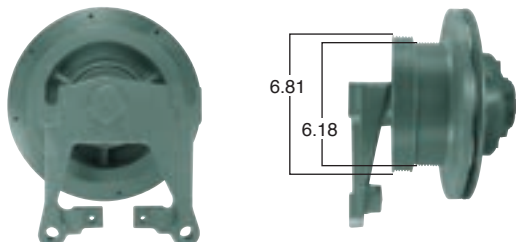

FLT91047

Fleetrite
Part Number

Rebuild with kit #
FLT9500HP

9.5" Friction Plate

2.56" Fan Pilot

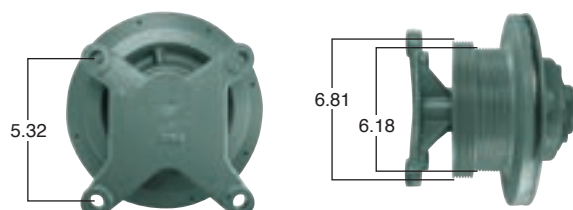

FLT91050 Fleetrite Part Number

Rebuild with kit # **FLT9500HP**

9.5" Friction Plate

2.56" Fan Pilot

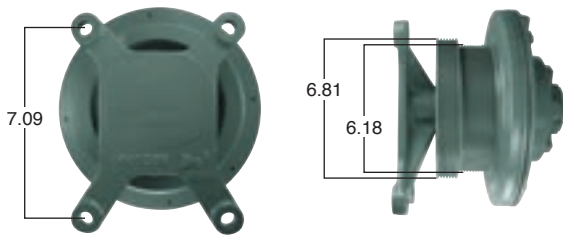

FLT91052 Fleetrite Part Number

Rebuild with kit # **FLT9500HP**

9.5" Friction Plate

5" Fan Pilot

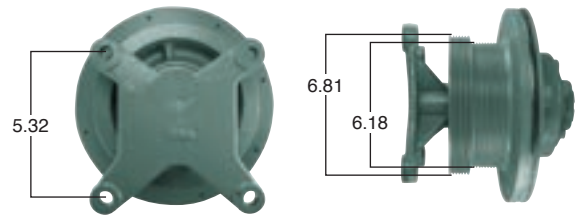

FLT91062 Fleetrite Part Number

Rebuild with kit # **FLT9506HP**

9.5" Friction Plate

2.56" Fan Pilot

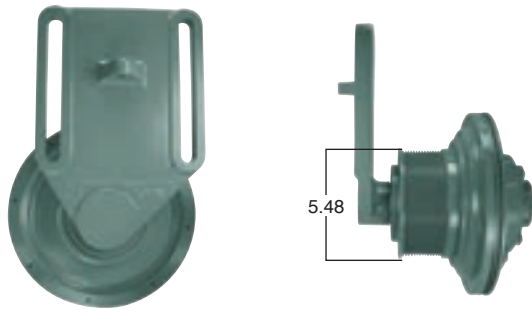

FLT91065 Fleetrite Part Number

Rebuild with kit # **FLT9500HP**

9.5" Friction Plate

2" Fan Pilot
Same as FLT91024

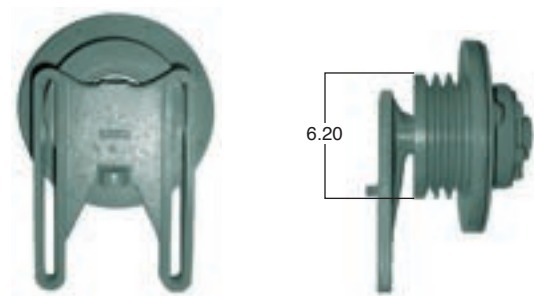

FLT91077 Fleetrite Part Number

Rebuild with kit # **FLT9500HP**

9.5" Friction Plate

2" Fan Pilot

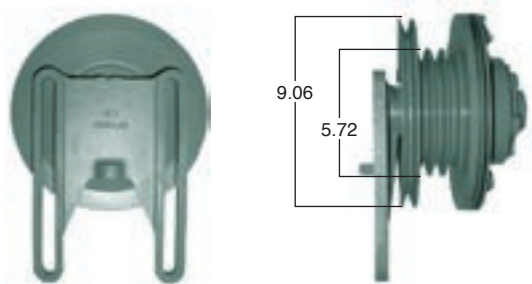

FLT91083 Fleetrite Part Number

Rebuild with kit # **FLT9500HP**

9.5" Friction Plate

2" Fan Pilot

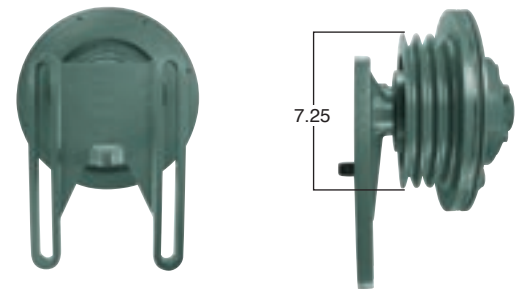

FLT91091 Fleetrite Part Number

Rebuild with kit # **FLT9500HP**

9.5" Friction Plate

2" Fan Pilot
Same as FLT91011

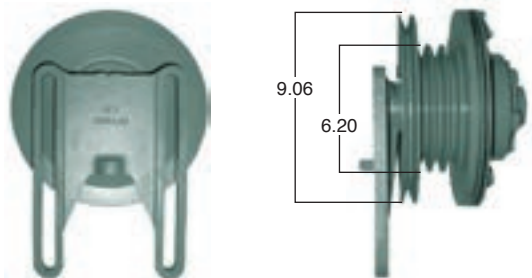

FLT91105 Fleetrite Part Number

Rebuild with kit # **FLT9500HP**

9.5" Friction Plate

2" Fan Pilot

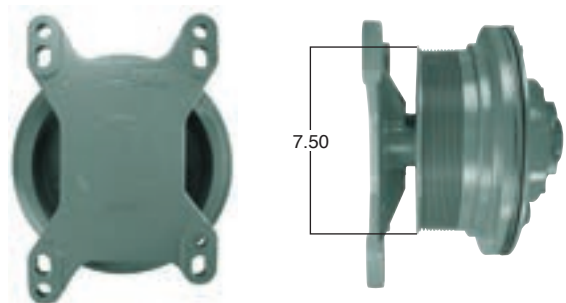

FLT91107

Fleetrite
Part Number

Rebuild with kit #
9500HP

9.5" Friction Plate

5" Fan Pilot

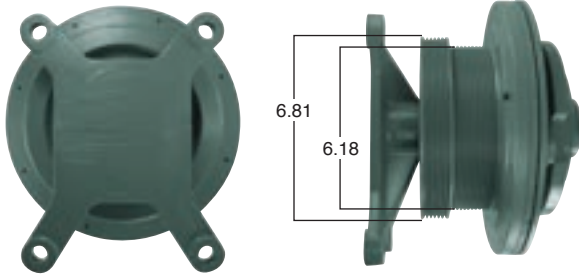

FLT91114

Fleetrite
Part Number

Rebuild with kit #
9500HP

9.5" Friction Plate

2.56" Fan Pilot

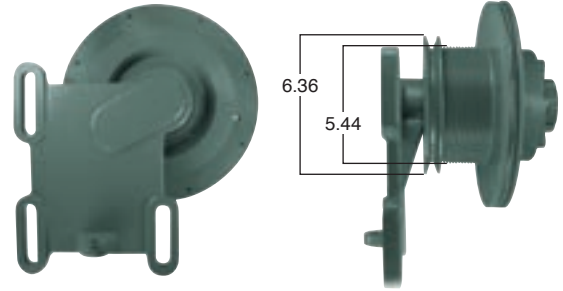

FLT98615

Fleetrite
Part Number

Rebuild with kit #
FLT14256

Or Convert to
2-Speed Version

FLT986152

Rebuild/convert with kit #
FLT24256

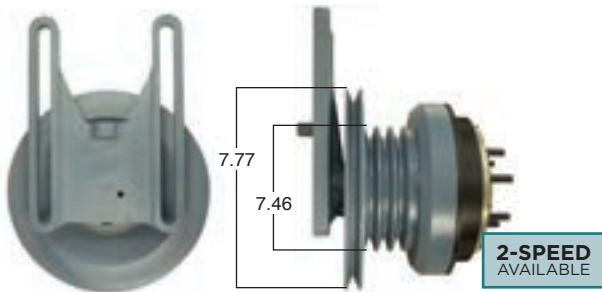

FLT98620

Fleetrite
Part Number

Rebuild with kit #
FLT14256

Or Convert to
2-Speed Version

FLT986202

Rebuild/convert with kit #
FLT24256

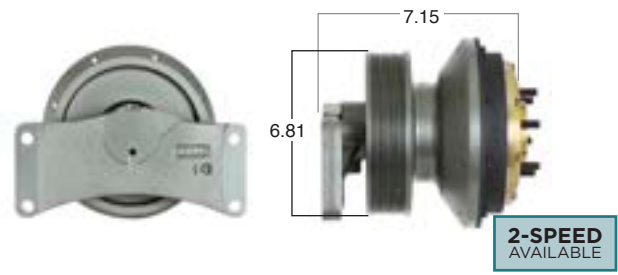

FLT98621

Fleetrite
Part Number

Rebuild with kit #
FLT14256

Or Convert to
2-Speed Version

FLT986212

Rebuild/convert with kit #
FLT24256

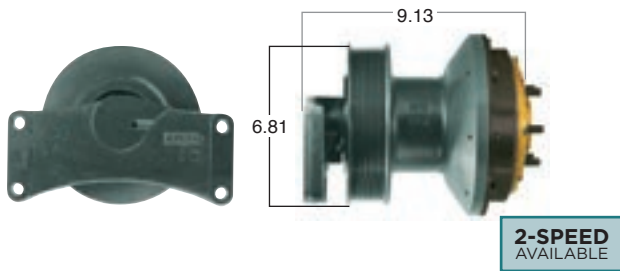

FLT98650

Fleetrite
Part Number

Rebuild with kit #
FLT14256

Or Convert to
2-Speed Version

FLT986502

Rebuild/convert with kit #
FLT24256

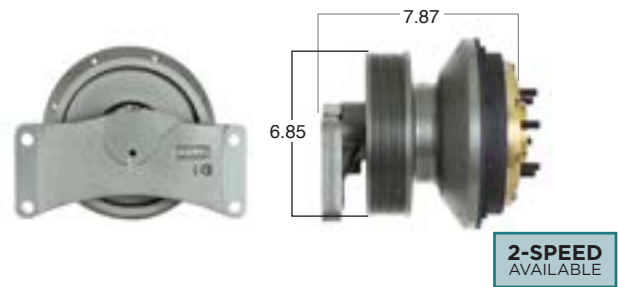

FLT98655

Fleetrite
Part Number

Rebuild with kit #
FLT14256

Or Convert to
2-Speed Version

FLT986552

Rebuild/convert with kit #
FLT24256

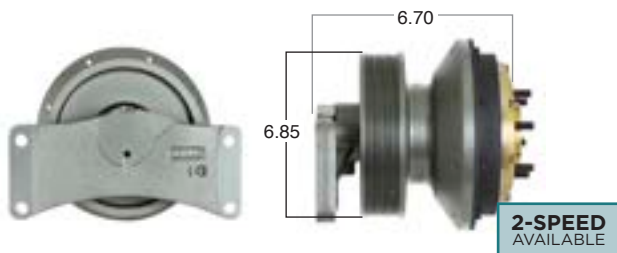

FLT99001

Fleetrite
Part Number

Rebuild with kit #
FLT14256

Or Convert to
2-Speed Version

FLT990012

Rebuild/convert with kit #
FLT24256

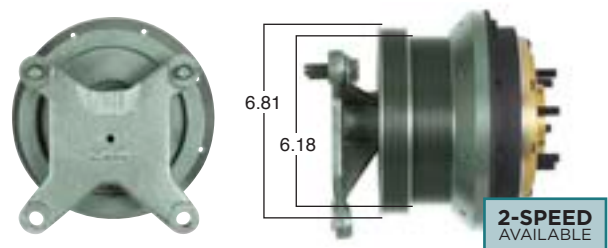

FLT99003

Fleetrite Part Number

Rebuild with kit # FLT14200

Or Convert to 2-Speed Version

FLT990032

Rebuild/convert with kit # FLT24200

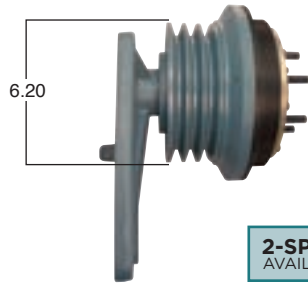

2-SPEED AVAILABLE

FLT99006

Fleetrite Part Number

Rebuild with kit # FLT14200

Or Convert to 2-Speed Version

FLT990062

Rebuild/convert with kit # FLT24200

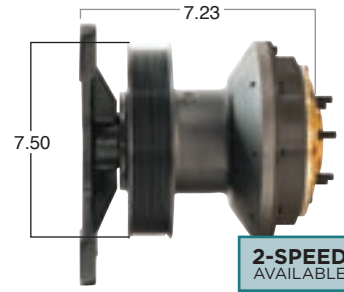

2-SPEED AVAILABLE

FLT99007

Fleetrite Part Number

Rebuild with kit # FLT14256

Or Convert to 2-Speed Version

FLT990072

Rebuild/convert with kit # FLT24256

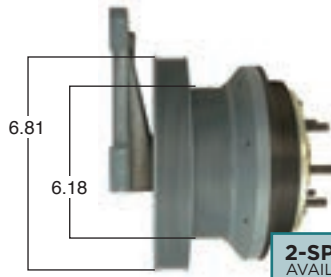

2-SPEED AVAILABLE

FLT99016

Fleetrite Part Number

Rebuild with kit # FLT14256

Or Convert to 2-Speed Version

FLT990162

Rebuild/convert with kit # FLT24256

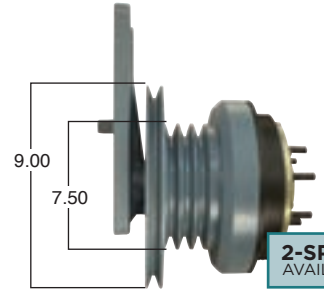

2-SPEED AVAILABLE

FLT99017

Fleetrite Part Number

Rebuild with kit # FLT14256

Or Convert to 2-Speed Version

FLT990172

Rebuild/convert with kit # FLT24256

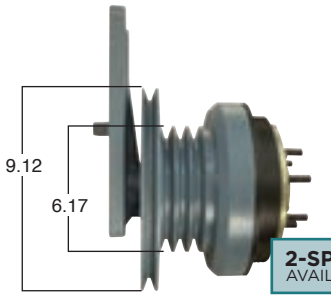

2-SPEED AVAILABLE

FLT99018

Fleetrite Part Number

Rebuild with kit # FLT14256

Or Convert to 2-Speed Version

FLT990182

Rebuild/convert with kit # FLT24256

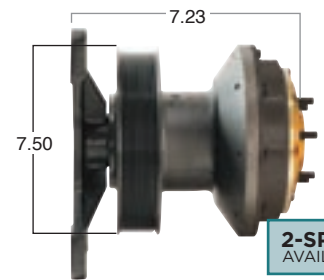

2-SPEED AVAILABLE

FLT99027

Fleetrite Part Number

Rebuild with kit # FLT14256

Or Convert to 2-Speed Version

FLT990272

Rebuild/convert with kit # FLT24256

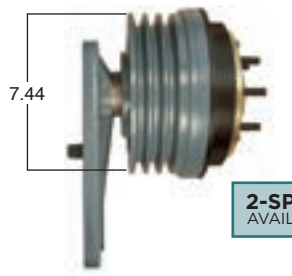

2-SPEED AVAILABLE

Also use Stud Kit FLT250SK

FLT99028

Fleetrite Part Number

Rebuild with kit # FLT14256

Or Convert to 2-Speed Version

FLT990282

Rebuild/convert with kit # FLT24256

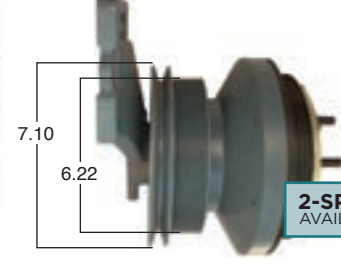

2-SPEED AVAILABLE

FLT99029 Fleetrite Part Number Rebuild with kit # **FLT14256**

Or Convert to 2-Speed Version ▶ **FLT990292** Rebuild/convert with kit # **FLT24256**

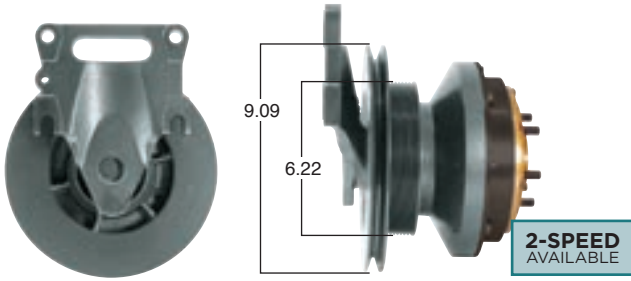

FLT99031 Fleetrite Part Number Rebuild with kit # **FLT14256**

Or Convert to 2-Speed Version ▶ **FLT990312** Rebuild/convert with kit # **FLT24256**

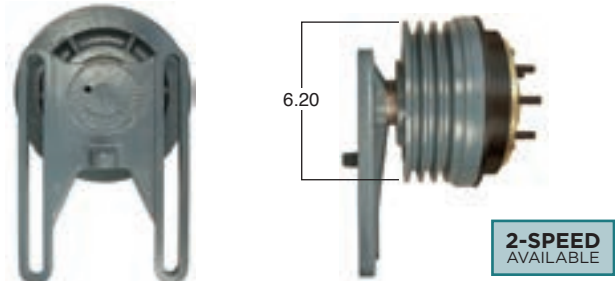

FLT99041 Fleetrite Part Number Rebuild with kit # **FLT14256**

Or Convert to 2-Speed Version ▶ **FLT990412** Rebuild/convert with kit # **FLT24256**

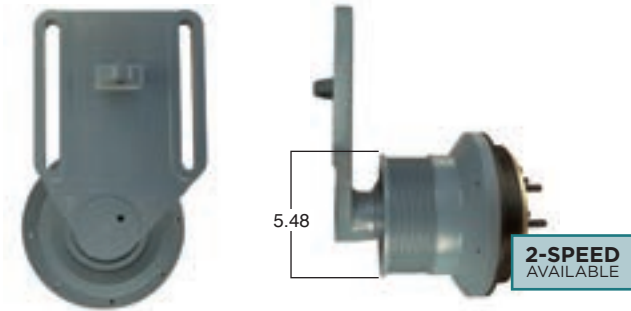

FLT99049 Fleetrite Part Number Rebuild with kit # **FLT14256**

Or Convert to 2-Speed Version ▶ **FLT990492** Rebuild/convert with kit # **FLT24256**

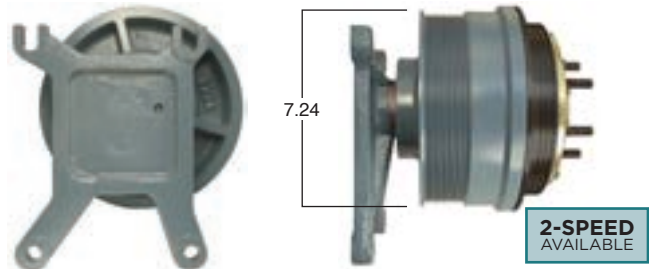

FLT99061 Fleetrite Part Number Rebuild with kit # **FLT14256**

Or Convert to 2-Speed Version ▶ **FLT990612** Rebuild/convert with kit # **FLT24256**

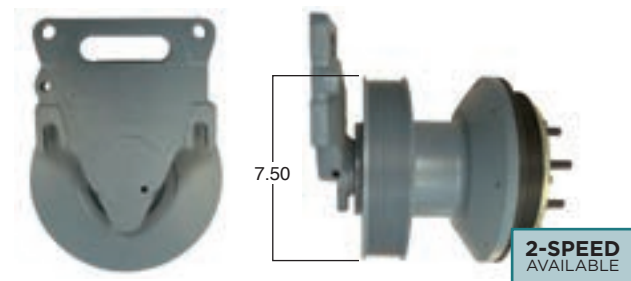

FLT99062 Fleetrite Part Number Rebuild with kit # **FLT14256**

Or Convert to 2-Speed Version ▶ **FLT990622** Rebuild/convert with kit # **FLT24256**

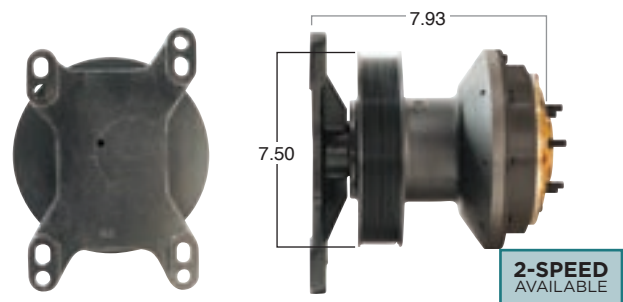

FLT99063 Fleetrite Part Number Rebuild with kit # **FLT14256**

Or Convert to 2-Speed Version ▶ **FLT990632** Rebuild/convert with kit # **FLT24256**

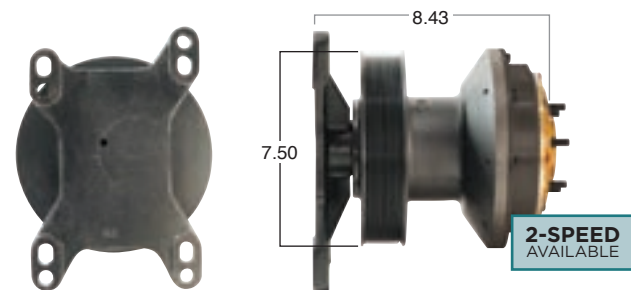

FLT99064 Fleetrite Part Number Rebuild with kit # **FLT14256**

Or Convert to 2-Speed Version ▶ **FLT990642** Rebuild/convert with kit # **FLT24256**

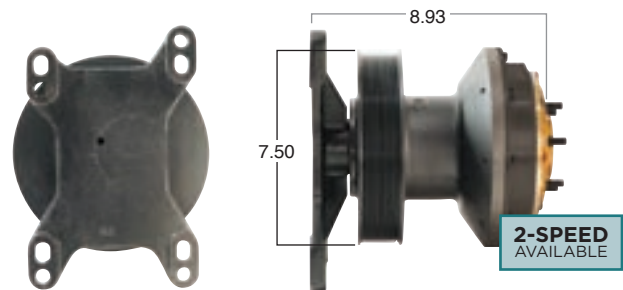

FLT99065

Fleetrite Part Number

Rebuild with kit # FLT14256

Or Convert to 2-Speed Version

FLT990652

Rebuild/convert with kit # FLT24256

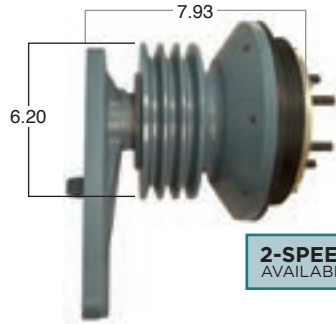

2-SPEED AVAILABLE

FLT99066

Fleetrite Part Number

Rebuild with kit # FLT14256

Or Convert to 2-Speed Version

FLT990662

Rebuild/convert with kit # FLT24256

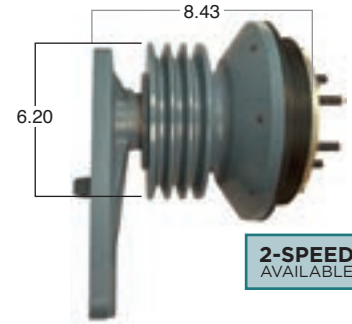

2-SPEED AVAILABLE

FLT99067

Fleetrite Part Number

Rebuild with kit # FLT14256

Or Convert to 2-Speed Version

FLT990672

Rebuild/convert with kit # FLT24256

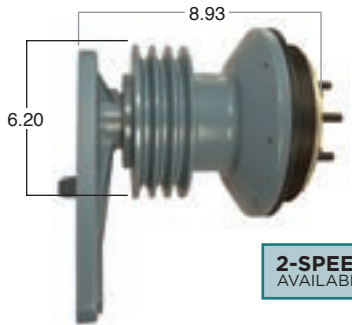

2-SPEED AVAILABLE

FLT99085

Fleetrite Part Number

Rebuild with kit # FLT14256

Or Convert to 2-Speed Version

FLT990852

Rebuild/convert with kit # FLT24256

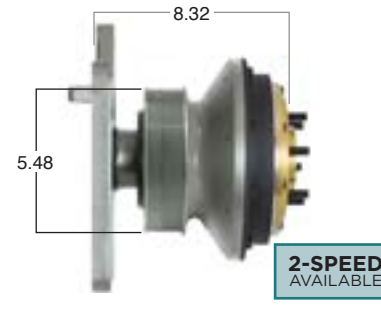

2-SPEED AVAILABLE

FLT99092

Fleetrite Part Number

Rebuild with kit # FLT14256

Or Convert to 2-Speed Version

FLT990922

Rebuild/convert with kit # FLT24256

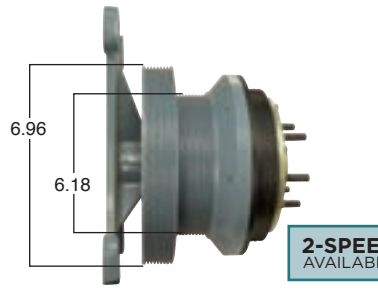

2-SPEED AVAILABLE

FLT99093

Fleetrite Part Number

Rebuild with kit # FLT14256

Or Convert to 2-Speed Version

FLT990932

Rebuild/convert with kit # FLT24256

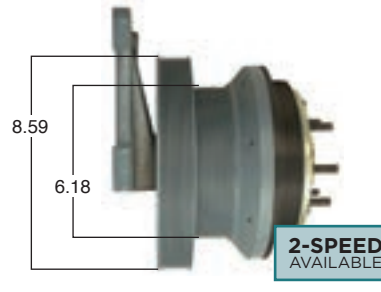

2-SPEED AVAILABLE

FLT99146

Fleetrite Part Number

Rebuild with kit # FLT14256

Or Convert to 2-Speed Version

FLT991462

Rebuild/convert with kit # FLT24256

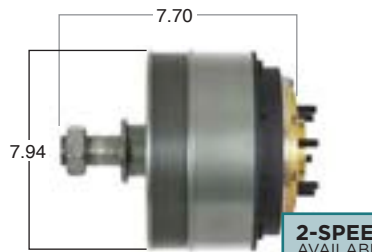

2-SPEED AVAILABLE

FLT99151

Fleetrite Part Number

Rebuild with kit # FLT14256

Or Convert to 2-Speed Version

FLT991512

Rebuild/convert with kit # FLT24256

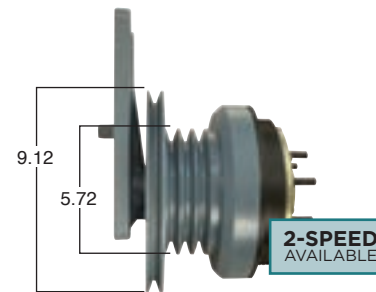

2-SPEED AVAILABLE

FLT99203 Fleetrite Part Number Rebuild with kit # **FLT14256**

Or Convert to 2-Speed Version ▶ **FLT992032** Rebuild/convert with kit # **FLT24256**

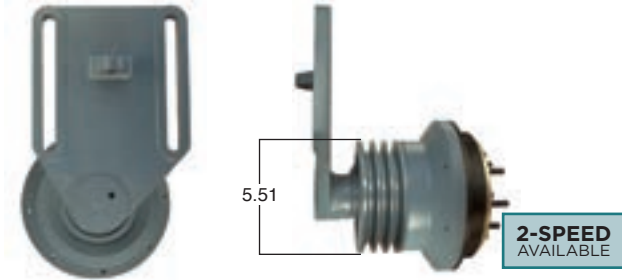

FLT99204 Fleetrite Part Number Rebuild with kit # **FLT14256**

Or Convert to 2-Speed Version ▶ **FLT992042** Rebuild/convert with kit # **FLT24256**

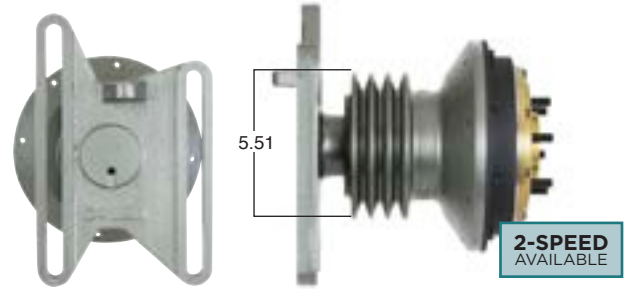

FLT99216 Fleetrite Part Number Rebuild with kit # **FLT14256**

Or Convert to 2-Speed Version ▶ **FLT992162** Rebuild/convert with kit # **FLT24256**

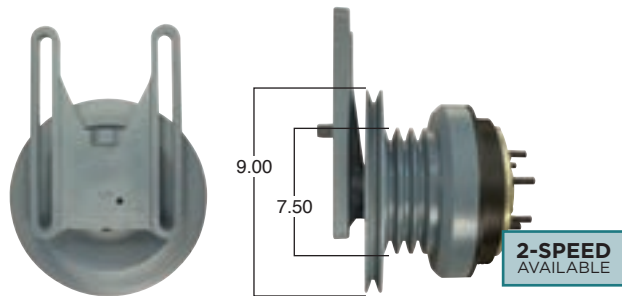

FLT99217 Fleetrite Part Number Rebuild with kit # **FLT14256**

Or Convert to 2-Speed Version ▶ **FLT992172** Rebuild/convert with kit # **FLT24256**

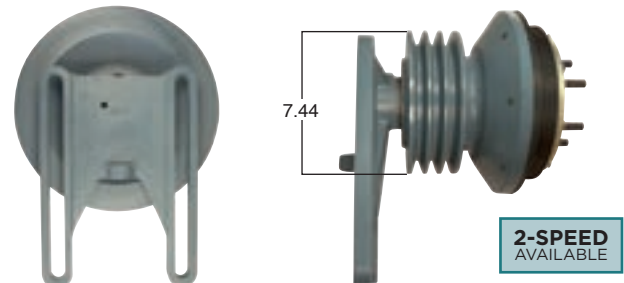

FLT99222 Fleetrite Part Number Rebuild with kit # **FLT14256**

Or Convert to 2-Speed Version ▶ **FLT992222** Rebuild/convert with kit # **FLT24256**

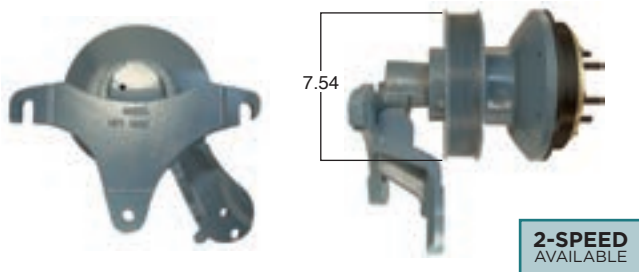

FLT99223 Fleetrite Part Number Rebuild with kit # **FLT14256**

Or Convert to 2-Speed Version ▶ **FLT992232** Rebuild/convert with kit # **FLT24256**

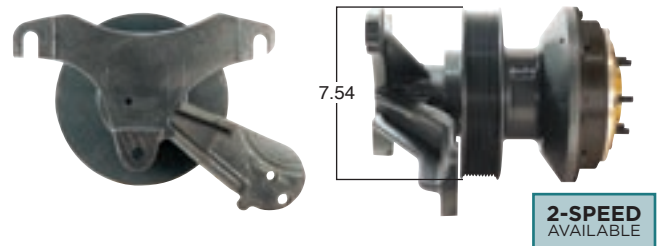

FLT99224 Fleetrite Part Number Rebuild with kit # **FLT14256**

Or Convert to 2-Speed Version ▶ **FLT992242** Rebuild/convert with kit # **FLT24256**

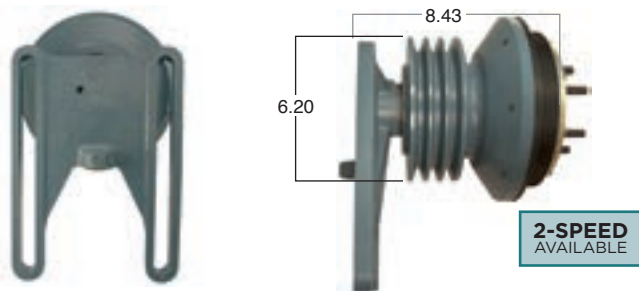

FLT99225 Fleetrite Part Number Rebuild with kit # **FLT14256**

Or Convert to 2-Speed Version ▶ **FLT992252** Rebuild/convert with kit # **FLT24256**

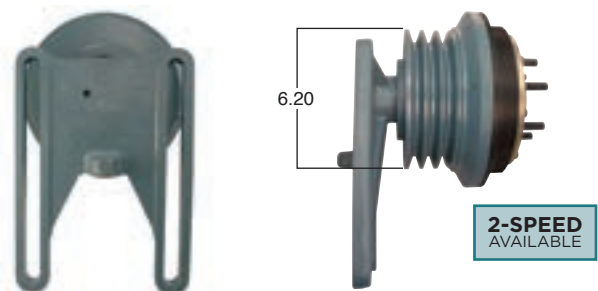

FLT99226

Fleetrite Part Number

Rebuild with kit # FLT14256

Or Convert to 2-Speed Version

FLT992262

Rebuild/convert with kit # FLT24256

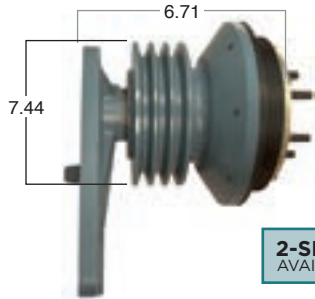

2-SPEED AVAILABLE

FLT99228

Fleetrite Part Number

Rebuild with kit # FLT14256

Or Convert to 2-Speed Version

FLT992282

Rebuild/convert with kit # FLT24256

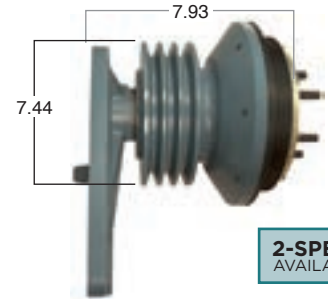

2-SPEED AVAILABLE

FLT99229

Fleetrite Part Number

Rebuild with kit # 14-256-1

Or Convert to 2-Speed Version

FLT992292

Rebuild/convert with kit # 24-256-1

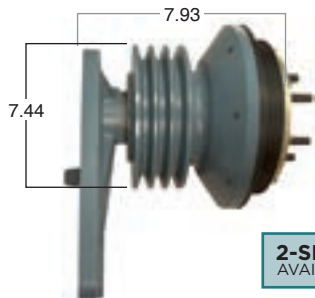

2-SPEED AVAILABLE

FLT99243

Fleetrite Part Number

Rebuild with kit # FLT14256

Or Convert to 2-Speed Version

FLT992432

Rebuild/convert with kit # FLT24256

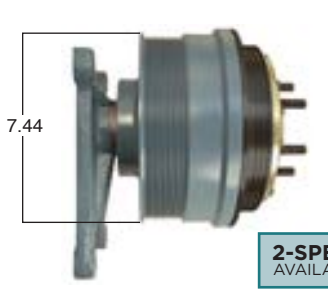

2-SPEED AVAILABLE

FLT99255

Fleetrite Part Number

Rebuild with kit # FLT14256

Or Convert to 2-Speed Version

FLT992552

Rebuild/convert with kit # FLT24256

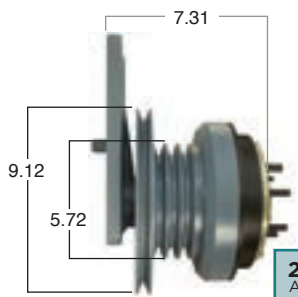

2-SPEED AVAILABLE

FLT99256

Fleetrite Part Number

Rebuild with kit # FLT14256

Or Convert to 2-Speed Version

FLT992562

Rebuild/convert with kit # FLT24256

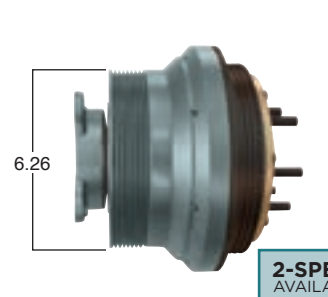

2-SPEED AVAILABLE

FLT99268

Fleetrite Part Number

Rebuild with kit # FLT14256

Or Convert to 2-Speed Version

FLT992682

Rebuild/convert with kit # FLT24256

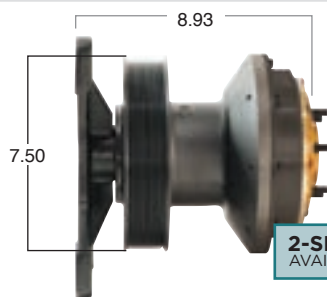

2-SPEED AVAILABLE

FLT99285

Fleetrite Part Number

Rebuild with kit # FLT14256

Or Convert to 2-Speed Version

FLT992852

Rebuild/convert with kit # FLT24256

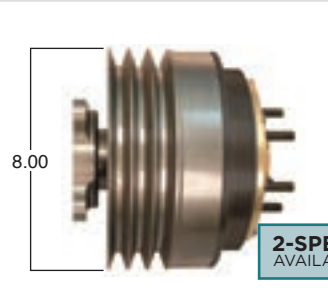

2-SPEED AVAILABLE

FLT99300 Fleetrite Part Number Rebuild with kit # **FLT14256**

Or Convert to 2-Speed Version ▶ **FLT993002** Rebuild/convert with kit # **FLT24256**

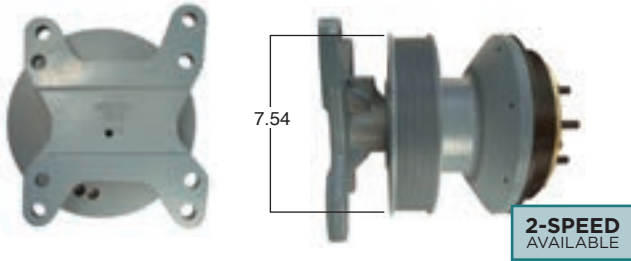

FLT99304 Fleetrite Part Number Rebuild with kit # **FLT14200**

Or Convert to 2-Speed Version ▶ **FLT993042** Rebuild/convert with kit # **FLT24200**

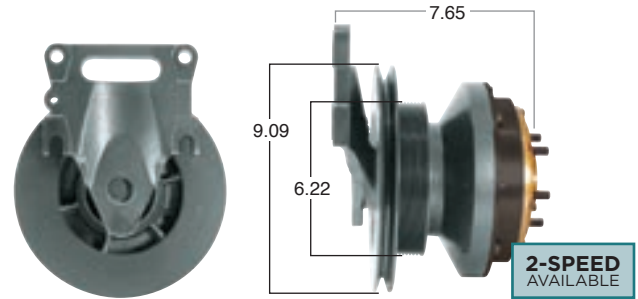

FLT99305 Fleetrite Part Number Rebuild with kit # **FLT14200**

Or Convert to 2-Speed Version ▶ **FLT993052** Rebuild/convert with kit # **FLT24200**

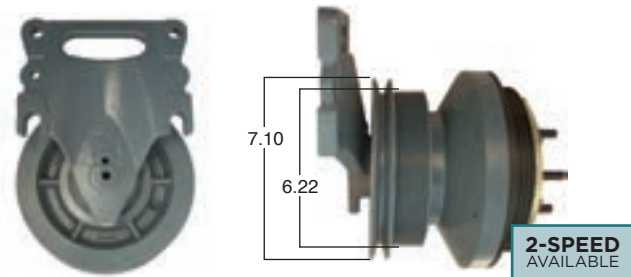

FLT99410 Fleetrite Part Number Rebuild with kit # **FLT14256**

Or Convert to 2-Speed Version ▶ **FLT994102** Rebuild/convert with kit # **FLT24256**

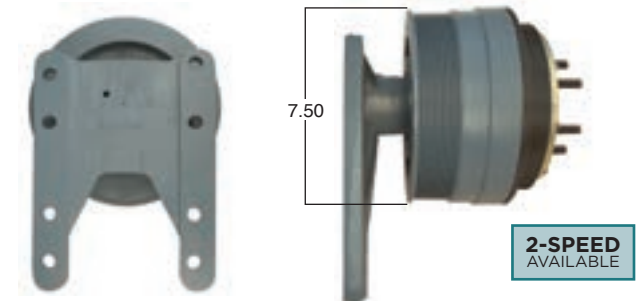

FLT99419 Fleetrite Part Number Rebuild with kit # **FLT14200**

Or Convert to 2-Speed Version ▶ **FLT994192** Rebuild/convert with kit # **FLT24200**

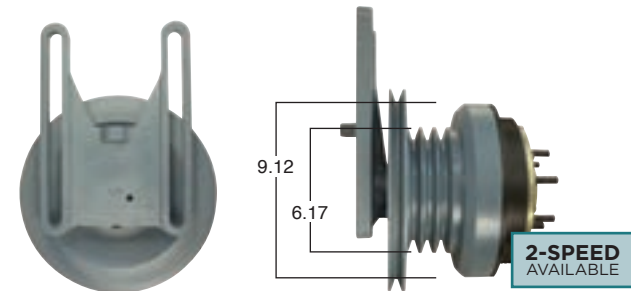

FLT99429 Fleetrite Part Number Rebuild with kit # **FLT14200**

Or Convert to 2-Speed Version ▶ **FLT994292** Rebuild/convert with kit # **FLT24200**

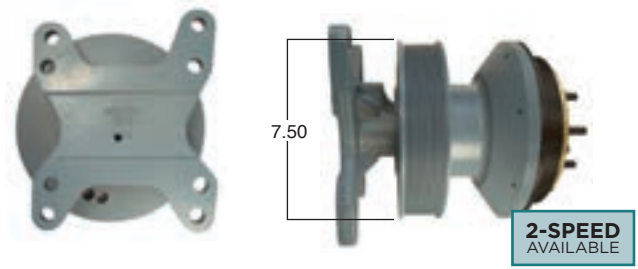

FLT99450 Fleetrite Part Number Rebuild with kit # **FLT14256**

Or Convert to 2-Speed Version ▶ **FLT994502** Rebuild/convert with kit # **FLT24256**

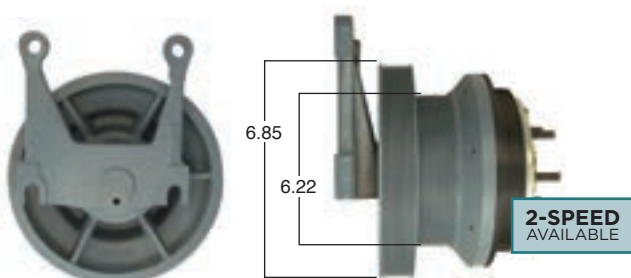

FLT99459 Fleetrite Part Number Rebuild with kit # **FLT14256**

Or Convert to 2-Speed Version ▶ **FLT994592** Rebuild/convert with kit # **FLT24256**

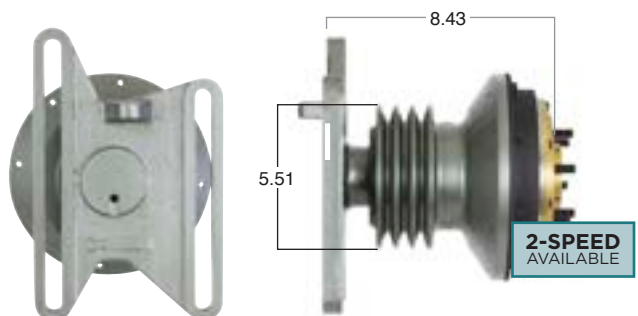

FLT99570 Fleetrite Part Number Rebuild with kit # FLT14256
 Or Convert to 2-Speed Version ▶ **FLT995702** Rebuild/convert with kit # FLT24256

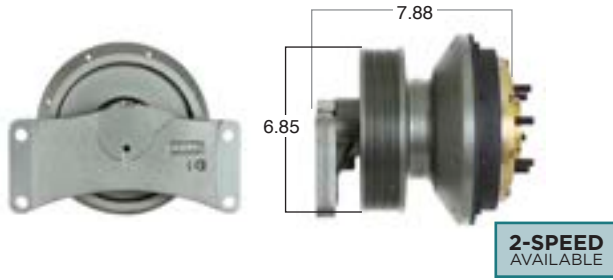

FLT99620 Fleetrite Part Number Rebuild with kit # FLT14256
 Or Convert to 2-Speed Version ▶ **FLT996202** Rebuild/convert with kit # FLT24256

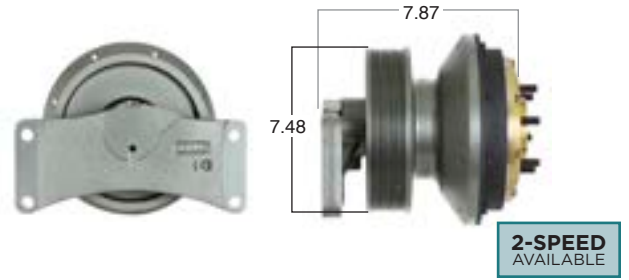

FLT99621 Fleetrite Part Number Rebuild with kit # FLT14256
 Or Convert to 2-Speed Version ▶ **FLT996212** Rebuild/convert with kit # FLT24256

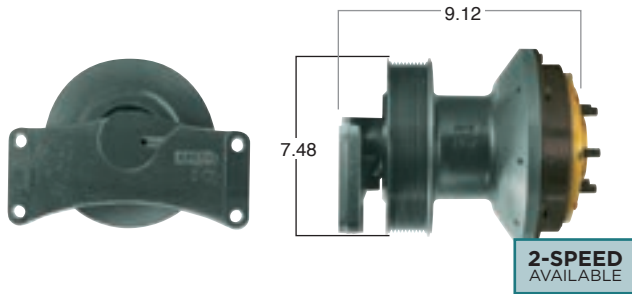

FLT99648 Fleetrite Part Number Rebuild with kit # FLT14200
 Or Convert to 2-Speed Version ▶ **FLT996482** Rebuild/convert with kit # FLT24200

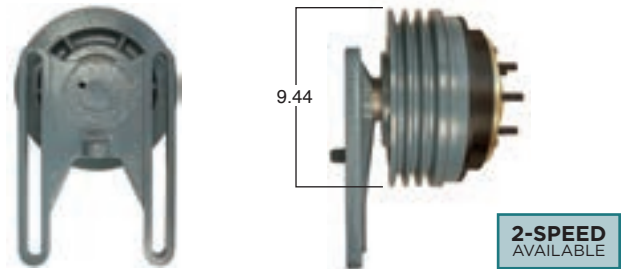

FLT99849 Fleetrite Part Number Rebuild with kit # FLT14256
 Or Convert to 2-Speed Version ▶ **FLT998492** Rebuild/convert with kit # FLT24256

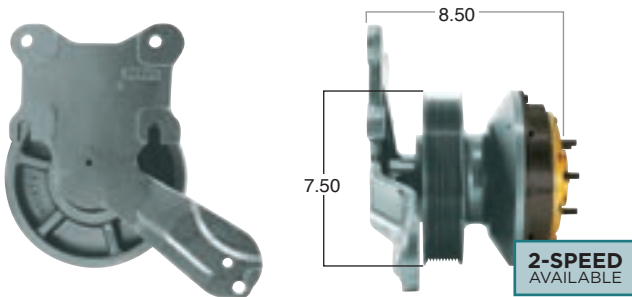

FLT99850 Fleetrite Part Number Rebuild with kit # FLT14256
 Or Convert to 2-Speed Version ▶ **FLT998502** Rebuild/convert with kit # FLT24256

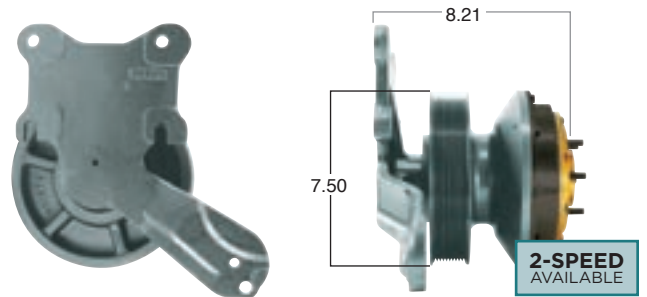

FLT91042 Fleetrite Part Number

Fleetrite Part Number

Rebuild with kit # **FLT9500HP**

9.5" Friction Plate

2.56" Fan Pilot

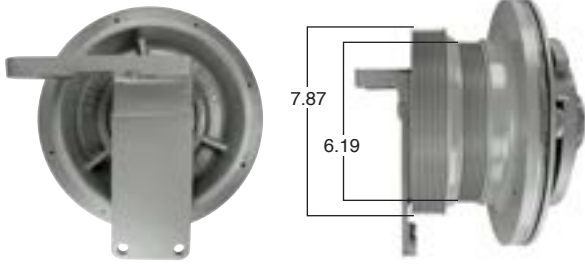

FLT91043 Fleetrite Part Number

Fleetrite Part Number

Rebuild with kit # **FLT9500HP**

9.5" Friction Plate

2.56" Fan Pilot

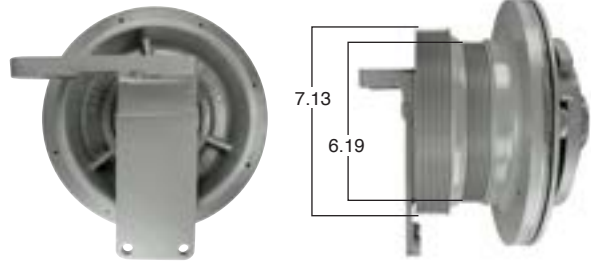

FLT98607 Fleetrite Part Number

Fleetrite Part Number

Rebuild with kit # **FLT14256**

Or Convert to 2-Speed Version

FLT986072

Rebuild/convert with kit # **FLT24256**

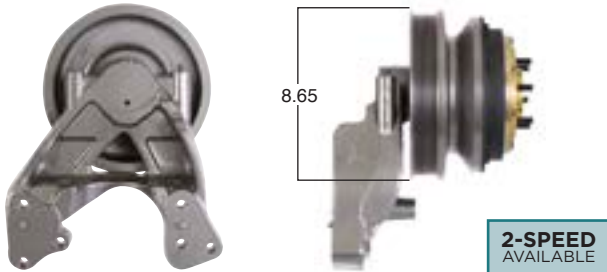

FLT98635 Fleetrite Part Number

Fleetrite Part Number

Rebuild with kit # **FLT14256**

Or Convert to 2-Speed Version

FLT986352

Rebuild/convert with kit # **FLT24256**



FLT99023 Fleetrite Part Number

Fleetrite Part Number

Rebuild with kit # **FLT14256**

Or Convert to 2-Speed Version

FLT990232

Rebuild/convert with kit # **FLT24256**

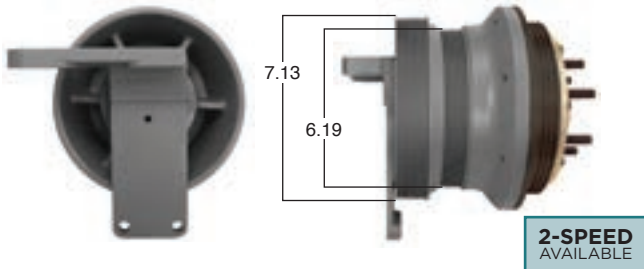

FLT99024 Fleetrite Part Number

Fleetrite Part Number

Rebuild with kit # **FLT14256**

Or Convert to 2-Speed Version

FLT990242

Rebuild/convert with kit # **FLT24256**

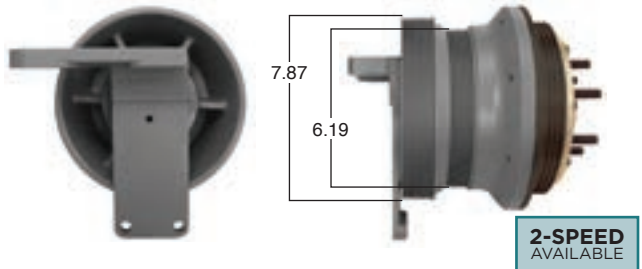

FLT99252 Fleetrite Part Number

Fleetrite Part Number

Rebuild with kit # **FLT14256**

Or Convert to 2-Speed Version

FLT992522

Rebuild/convert with kit # **FLT24256**

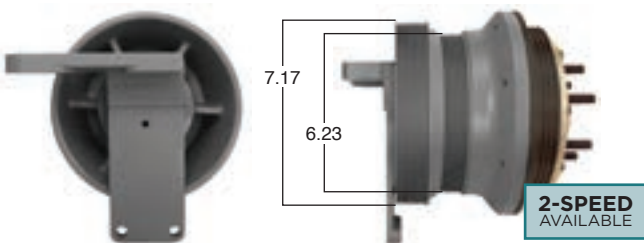

FLT99562 Fleetrite Part Number

Fleetrite Part Number

Rebuild with kit # **FLT14256**

Or Convert to 2-Speed Version

FLT995622

Rebuild/convert with kit # **FLT24256**



FLT997572 Fleetrite Part Number

Rebuild with kit # FLT24256

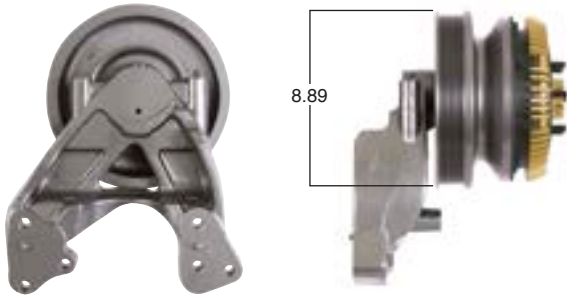

FLT999702 Fleetrite Part Number

Rebuild with kit # FLT24256

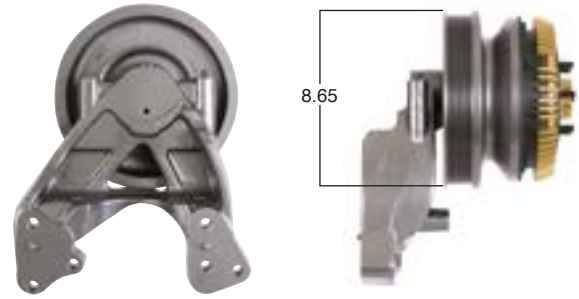

COMPATIBLE WITH INTERNATIONAL™ “CLUTCH PACK” APPLICATIONS

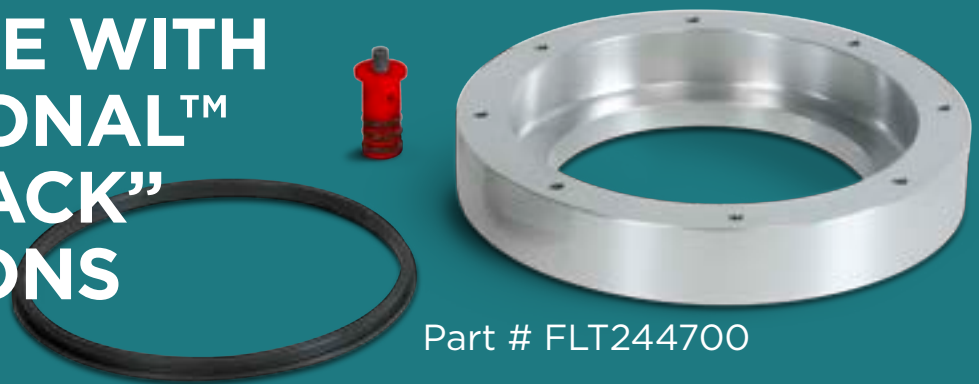

Part # FLT244700

Unlike standard, all-in-one fan clutches, some specific International applications have a unique modular system. **This system requires the fan clutch to be disassembled and re-installed component by component.**

THE PROBLEM:

The pulleys on these particular fan clutches have a **flat front** that does not allow for a typical rebuild kit.

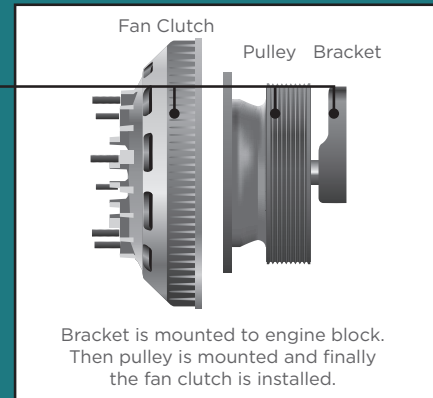
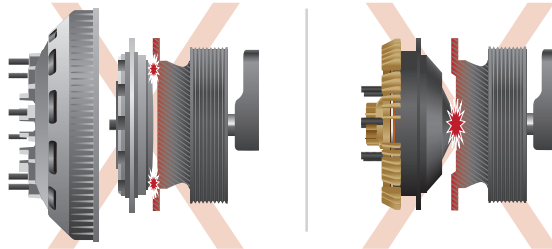

The OEM requires that you purchase a separate complete rebuild kit (clutch pack) that they have made specifically for this application.

THE SOLUTION:

Instead of creating a separate rebuild kit, we have created a unique **riser plate** that allows for the installation of our standard ON/OFF or 2-Speed kit.

- Inexpensive compared to complete rebuild kit
- Does not change the overall dimensions
- Includes adapter ring to cover multiple applications

* Installation of the FLT244700 also requires a unique extended air cartridge (included).

THE SOLUTION

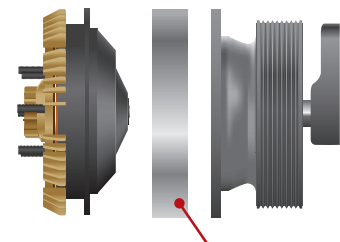

Simply install the **FLT244700 Riser Plate** during the assembly process to create a kit-friendly pulley.

FLT99247

Fleetrite
Part Number

Rebuild with kit #
FLT14256

Or Convert to
2-Speed Version

FLT992472

Rebuild/convert with kit #
FLT24256

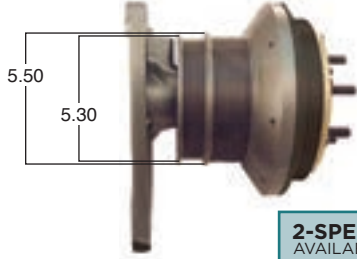

**2-SPEED
AVAILABLE**

FLT99407

Fleetrite
Part Number

Rebuild with kit #
FLT14256

Or Convert to
2-Speed Version

FLT994072

Rebuild/convert with kit #
FLT24256

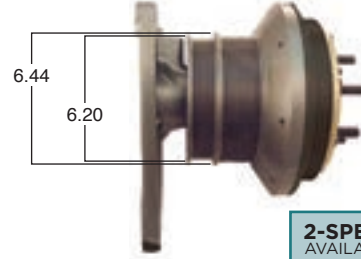

**2-SPEED
AVAILABLE**

FLT99423

Fleetrite
Part Number

Rebuild with kit #
FLT14256

Or Convert to
2-Speed Version

FLT994232

Rebuild/convert with kit #
FLT24256

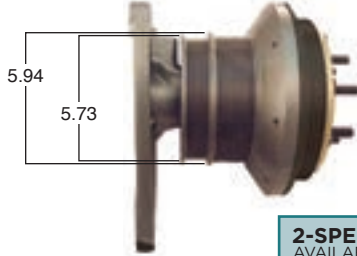

**2-SPEED
AVAILABLE**

FLT99487

Fleetrite
Part Number

Rebuild with kit #
FLT14256

Or Convert to
2-Speed Version

FLT994872

Rebuild/convert with kit #
FLT24256

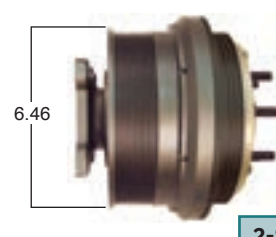

**2-SPEED
AVAILABLE**

FLT99492

Fleetrite
Part Number

Rebuild with kit #
FLT14256

Or Convert to
2-Speed Version

FLT994922

Rebuild/convert with kit #
FLT24256

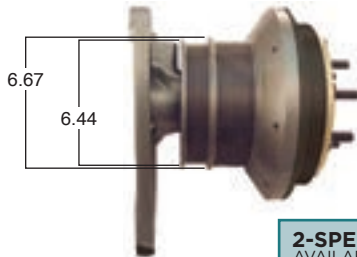

**2-SPEED
AVAILABLE**

FLT99493

Fleetrite
Part Number

Rebuild with kit #
FLT14256

Or Convert to
2-Speed Version

FLT994932

Rebuild/convert with kit #
FLT24256

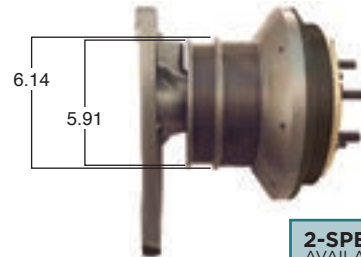

**2-SPEED
AVAILABLE**

FLT99494

Fleetrite
Part Number

Rebuild with kit #
FLT14256

Or Convert to
2-Speed Version

FLT994942

Rebuild/convert with kit #
FLT24256

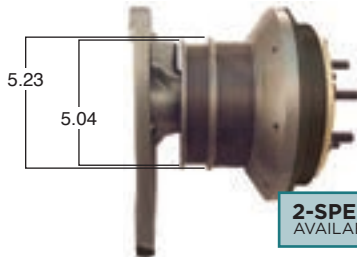

**2-SPEED
AVAILABLE**

FLT99495

Fleetrite
Part Number

Rebuild with kit #
FLT14256

Or Convert to
2-Speed Version

FLT994952

Rebuild/convert with kit #
FLT24256

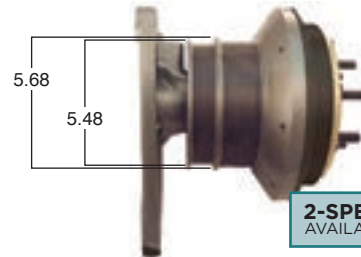

**2-SPEED
AVAILABLE**

FLT99497

Fleetrite
Part Number

Rebuild with kit #
FLT14256

Or Convert to
2-Speed Version

FLT994972

Rebuild/convert with kit #
FLT24256

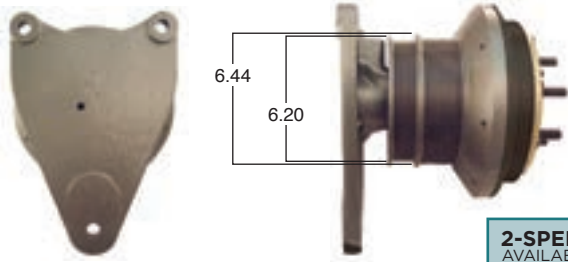

FLT99498

Fleetrite
Part Number

Rebuild with kit #
FLT14256

Or Convert to
2-Speed Version

FLT994982

Rebuild/convert with kit #
FLT24256

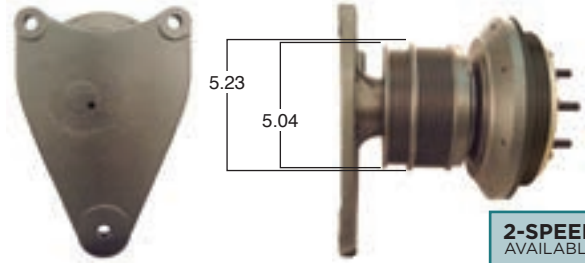

FLT99499

Fleetrite
Part Number

Rebuild with kit #
FLT14256

Or Convert to
2-Speed Version

FLT994992

Rebuild/convert with kit #
FLT24256

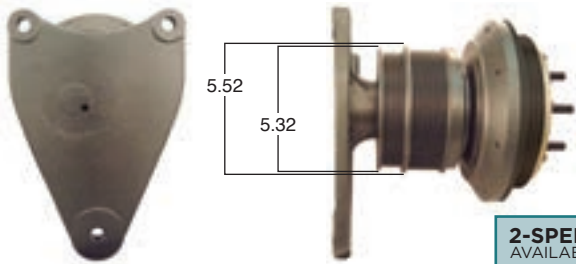

FLT99472

Fleetrite
Part Number

Rebuild with kit #
FLT24256

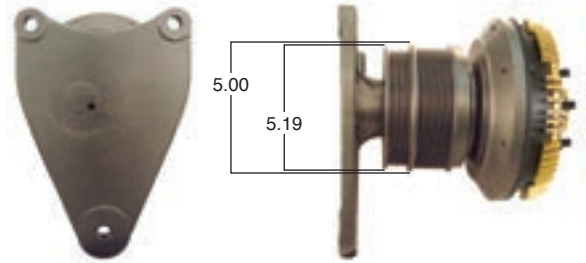

FLT999542

Fleetrite
Part Number

Rebuild with kit #
FLT24256

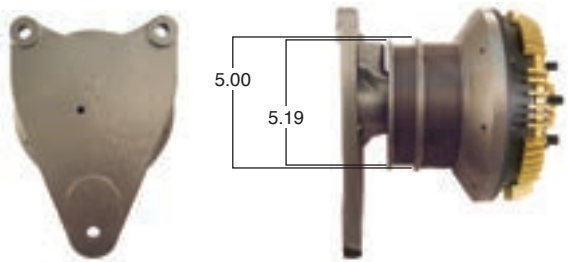

FLT999552

Fleetrite
Part Number

Rebuild with kit #
FLT24256

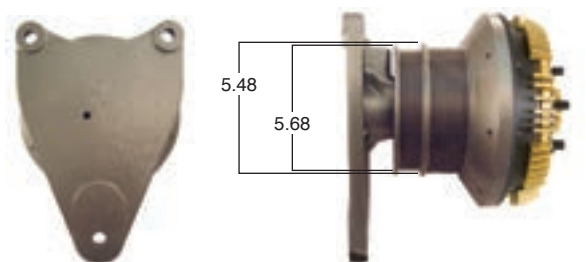

FLT91039

Fleetrite
Part Number

Rebuild with kit #
FLT9500HP

9.5" Friction Plate

2" Fan Pilot

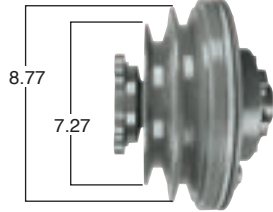

OR
Convert to a
Spring-Engaged
fan clutch

FLT91039GTN

Fleetrite
Part Number

Rebuild with kit #
FLT14200

9.5" Friction Plate

2" Fan Pilot

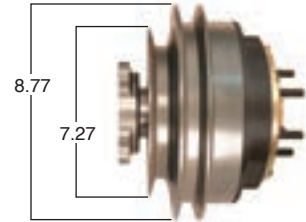

FLT91040

Fleetrite
Part Number

Rebuild with kit #
FLT9500HP

9.5" Friction Plate

2" Fan Pilot

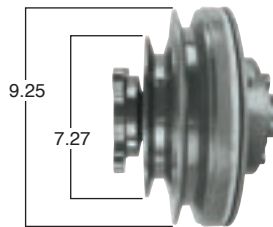

OR
Convert to a
Spring-Engaged
fan clutch

FLT91040GTN

Fleetrite
Part Number

Rebuild with kit #
FLT14200

9.5" Friction Plate

2" Fan Pilot

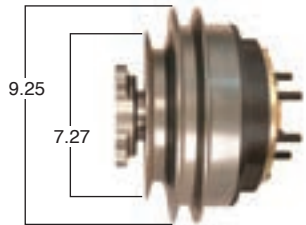

FLT91041

Fleetrite
Part Number

Rebuild with kit #
FLT9500HP

9.5" Friction Plate

2" Fan Pilot

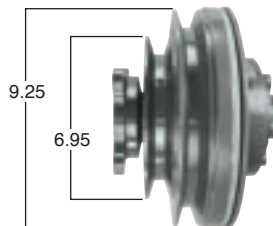

OR
Convert to a
Spring-Engaged
fan clutch

FLT91041GTN

Fleetrite
Part Number

Rebuild with kit #
FLT14200

9.5" Friction Plate

2" Fan Pilot

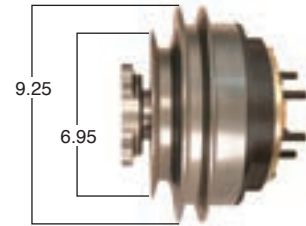

FLT99852

Fleetrite
Part Number

Rebuild with kit #
FLT14256

Or Convert to
2-Speed Version

FLT998522

Rebuild/convert with kit #
FLT24256



Not finding what you're
looking for? Check our website
www.fleetrite.com
for even more fan clutch related
information.

FLT98630

Fleetrite Part Number

Rebuild with kit # FLT14256

Or Convert to 2-Speed Version

FLT986302

Rebuild/convert with kit # FLT24256

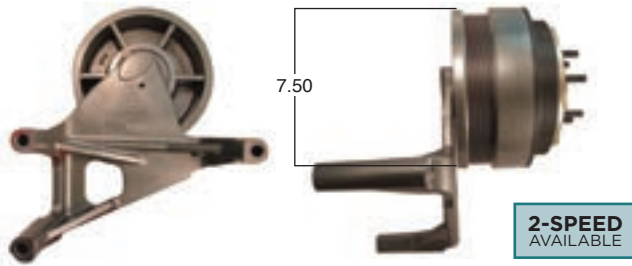

FLT98638

Fleetrite Part Number

Rebuild with kit # FLT14256

Or Convert to 2-Speed Version

FLT986382

Rebuild/convert with kit # FLT24256

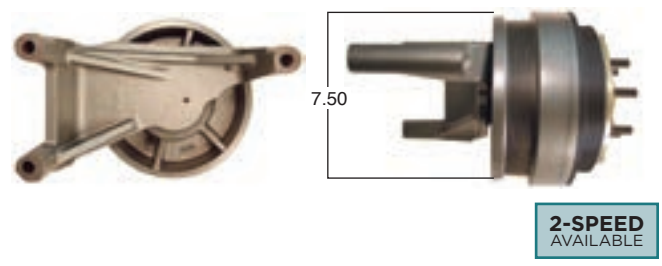

FLT99077

Fleetrite Part Number

Rebuild with kit # FLT142561

Or Convert to 2-Speed Version

FLT990772

Rebuild/convert with kit # FLT242561

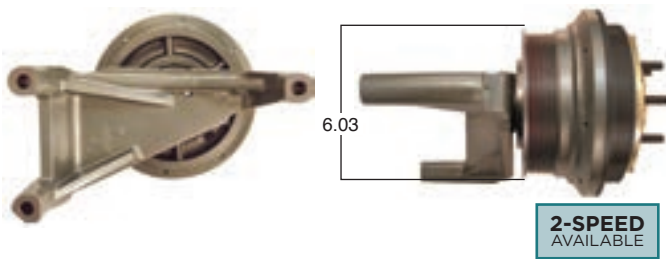

FLT99142

Fleetrite Part Number

Rebuild with kit # FLT142561

Or Convert to 2-Speed Version

FLT991422

Rebuild/convert with kit # FLT242561

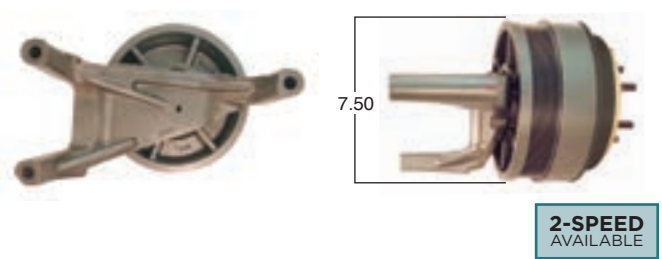

FLT99143

Fleetrite Part Number

Rebuild with kit # FLT142561

Or Convert to 2-Speed Version

FLT991432

Rebuild/convert with kit # FLT242561

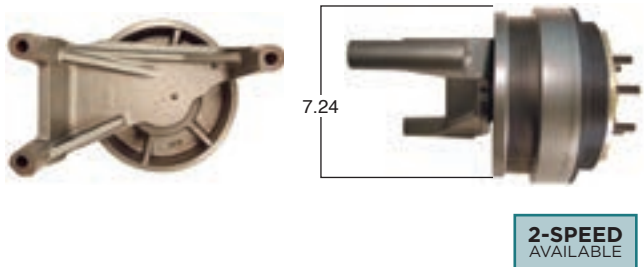

FLT99251

Fleetrite Part Number

Rebuild with kit # FLT142561

Or Convert to 2-Speed Version

FLT992512

Rebuild/convert with kit # FLT242561

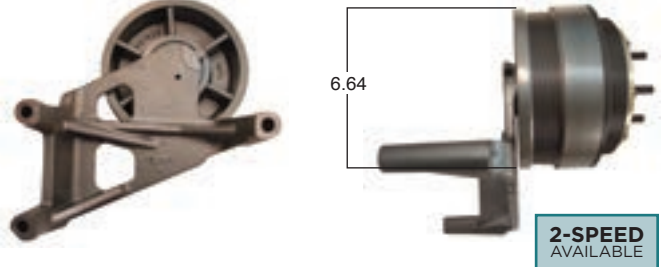

FLT99275

Fleetrite Part Number

Rebuild with kit # FLT142561

Or Convert to 2-Speed Version

FLT992752

Rebuild/convert with kit # FLT242561

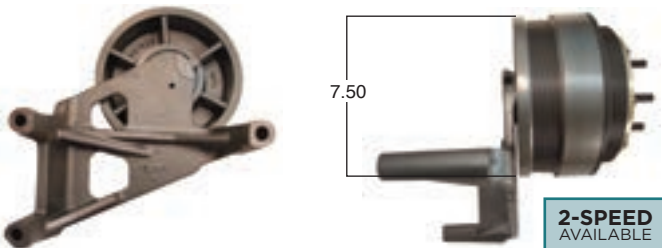

FLT99301

Fleetrite Part Number

Rebuild with kit # FLT142561

Or Convert to 2-Speed Version

FLT993012

Rebuild/convert with kit # FLT242561

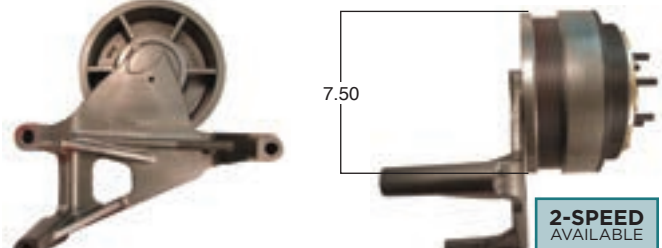

FLT99302 Fleetrite Part Number Rebuild with kit # FLT142561

Or Convert to 2-Speed Version ▶ **FLT993022** Rebuild/convert with kit # FLT242561

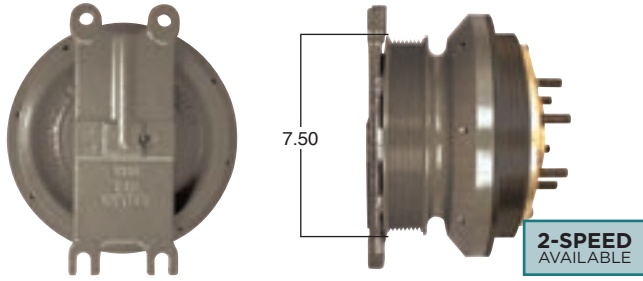

FLT99336 Fleetrite Part Number Rebuild with kit # FLT142561

Or Convert to 2-Speed Version ▶ **FLT993362** Rebuild/convert with kit # FLT242561

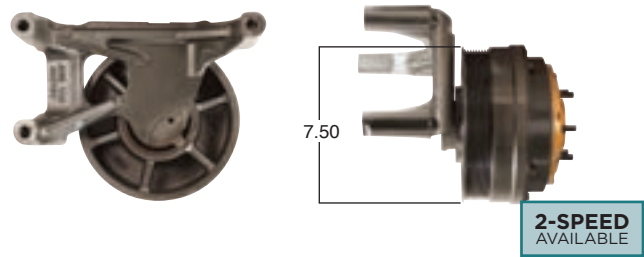

FLT99381 Fleetrite Part Number Rebuild with kit # FLT14256

Or Convert to 2-Speed Version ▶ **FLT993812** Rebuild/convert with kit # FLT24256

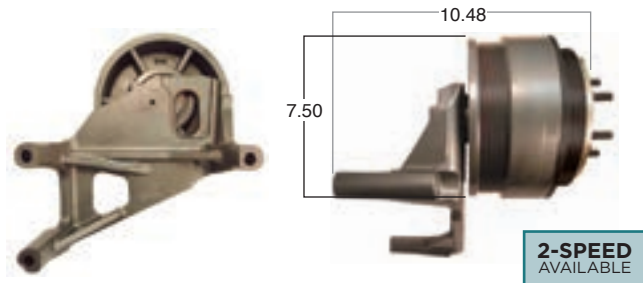

FLT99455 Fleetrite Part Number Rebuild with kit # FLT142561

Or Convert to 2-Speed Version ▶ **FLT994552** Rebuild/convert with kit # FLT242561

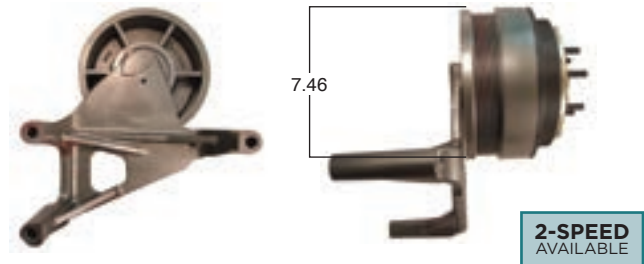

FLT99859 Fleetrite Part Number Rebuild with kit # FLT14256

Or Convert to 2-Speed Version ▶ **FLT998592** Rebuild/convert with kit # FLT24256

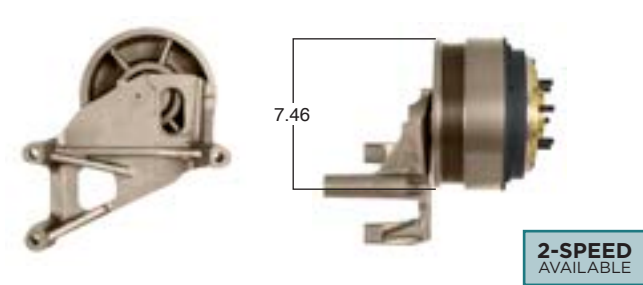

FLT99893 Fleetrite Part Number Rebuild with kit # FLT142561

Or Convert to 2-Speed Version ▶ **FLT998932** Rebuild/convert with kit # FLT242561

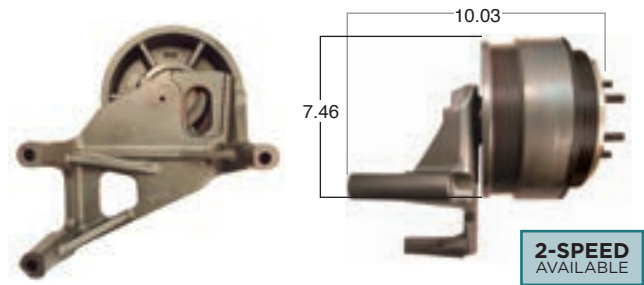

FLT98627 Fleetrite Part Number Rebuild with kit # FLT14256

Or Convert to 2-Speed Version

FLT986272

Rebuild/convert with kit # FLT24256

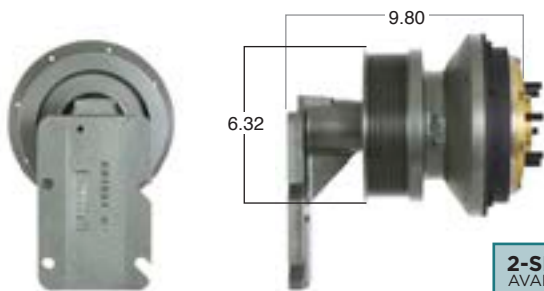

2-SPEED AVAILABLE

FLT98631 Fleetrite Part Number Rebuild with kit # FLT14256

Or Convert to 2-Speed Version

FLT986312

Rebuild/convert with kit # FLT24256

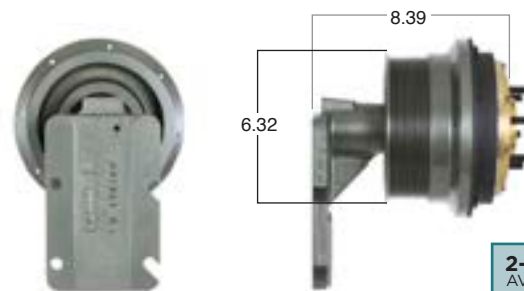

2-SPEED AVAILABLE

FLT98632 Fleetrite Part Number Rebuild with kit # FLT142561

Or Convert to 2-Speed Version

FLT986322

Rebuild/convert with kit # FLT242561

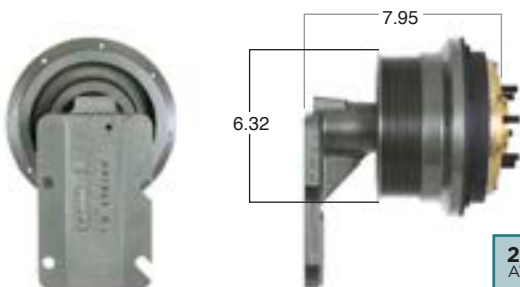

2-SPEED AVAILABLE

FLT99590 Fleetrite Part Number Rebuild with kit # FLT14256

Or Convert to 2-Speed Version

FLT995902

Rebuild/convert with kit # FLT24256

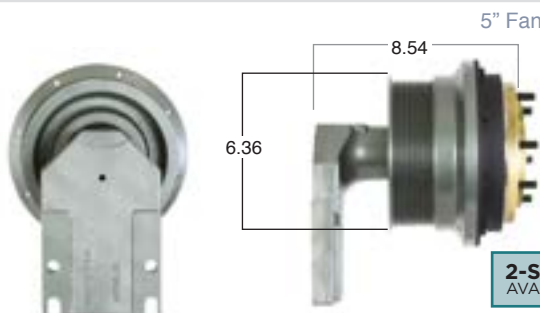

2-SPEED AVAILABLE

FLT99592 Fleetrite Part Number Rebuild with kit # FLT14256

Or Convert to 2-Speed Version

FLT995922

Rebuild/convert with kit # FLT24256

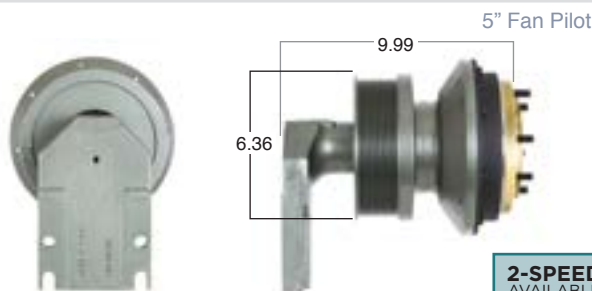

2-SPEED AVAILABLE

*Not finding what you're looking for? Check our website **www.fleetrite.com** for even more fan clutch related information.*

FLT91073

Fleetrite Part Number

Rebuild with kit # **FLT9500HP**

9.5" Friction Plate

2.56" Fan Pilot

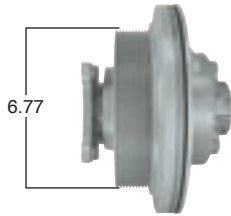

FLT91084

Fleetrite Part Number

Rebuild with kit # **FLT9500HP**

9.5" Friction Plate

2.56" Fan Pilot

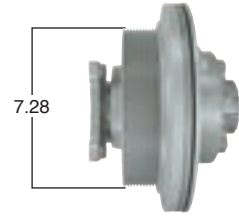

FLT99019

Fleetrite Part Number

Rebuild with kit # **FLT14256**

Or Convert to 2-Speed Version

▶ **FLT990192**

Rebuild/convert with kit # **FLT24256**

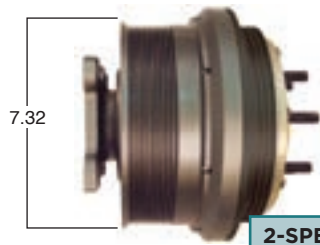

2-SPEED AVAILABLE

FLT99196

Fleetrite Part Number

Rebuild with kit # **FLT14256**

Or Convert to 2-Speed Version

▶ **FLT991962**

Rebuild/convert with kit # **FLT24256**



2-SPEED AVAILABLE

FLT99454

Fleetrite Part Number

Rebuild with kit # **FLT14256**

Or Convert to 2-Speed Version

▶ **FLT994542**

Rebuild/convert with kit # **FLT24256**



2-SPEED AVAILABLE

FLT99465

Fleetrite Part Number

Rebuild with kit # **FLT14256**

Or Convert to 2-Speed Version

▶ **FLT994652**

Rebuild/convert with kit # **FLT24256**



2-SPEED AVAILABLE

FLT99466

Fleetrite Part Number

Rebuild with kit # **FLT14256**

Or Convert to 2-Speed Version

▶ **FLT994662**

Rebuild/convert with kit # **FLT24256**

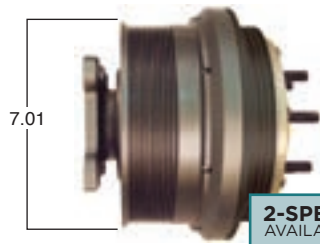

2-SPEED AVAILABLE

*Not finding what you're looking for? Check our website **www.fleetrite.com** for even more fan clutch related information.*

Mfr. Part #	Fleetrite On/Off	On/Off Kit	FLT 2-Speed	2-Speed Kit	Also Use	Pg. #
59xxxx						
590000	FLT90000	FLT7500HP	-	-		43
590001	FLT90001	FLT7500HP	-	-		41
590002	FLT90002	FLT7500HP	-	-		41
590003	FLT90003	FLT7500HP	-	-		67
590004	FLT90004	FLT7500HP	-	-		67
590005	FLT90005	FLT7500HP	-	-		17
590007	FLT90007	FLT7500HP	-	-		17
590008	FLT90008	FLT7500HP	-	-		41
590009	FLT90009	FLT7500HP	-	-		67
590010	FLT90010	FLT7500HP	-	-		41
590011	FLT90011	FLT7500HP	-	-		67
590012	FLT90012	FLT7500HP	-	-		41
590013	FLT90013	FLT7500HP	-	-		41
590014	FLT90014	FLT7500HP	-	-		17
590015	FLT90015	FLT7500HP	-	-		17
590016	FLT90016	FLT7500HP	-	-		41
590017	FLT90017	FLT7500HP	-	-		42
590018	FLT90018	FLT7500HP	-	-		67
591000	FLT91000	FLT9500HP	-	-		43
591001	FLT91001	FLT9500HP	-	-		43
591002	FLT91002	FLT9500HP	-	-		17
591003	FLT91003	FLT9505SP	-	-		18
591004	FLT91004	FLT9500HP	-	-		43
591005	FLT91005	FLT9500HP	-	-		18
591006	FLT91006	FLT9500HP	-	-		43
591007	FLT91007	FLT9500HP	-	-		18
591008	FLT91008	FLT9500HP	-	-		18
591009	FLT91009	FLT9500HP	-	-		43
591010	FLT91010	FLT9500HP	-	-		43
591011	FLT91011	FLT9500HP	-	-		68
591012	FLT91012	FLT9500HP	-	-		18
591013	FLT91013	FLT9500HP	-	-		18
591014	FLT91014	FLT9500HP	-	-		18
591015	FLT91015	FLT9500HP	-	-		18
591016	FLT91016	FLT9500HP	-	-		43
591017	FLT91017	FLT9505SP	-	-		19
591018	FLT91018	FLT9500HP	-	-		43
591019	FLT91019	FLT9500HP	-	-		44
591020	FLT91020	FLT9500HP	-	-		19
591021	FLT91021	FLT9500HP	-	-		44
591022	FLT91022	FLT9500HP	-	-		44
591023	FLT91023	FLT9500HP	-	-		68
591024	FLT91024	FLT9500HP	-	-		68
591025	FLT91025	FLT9500HP	-	-		19
591026	FLT91026	FLT9500HP	-	-		44
591027	FLT91027	FLT9500HP	-	-		19
591028	FLT91028	FLT9500HP	-	-		19
591029	FLT91029	FLT9500HP	-	-		44
591030	FLT91030	FLT9500HP	-	-		44
591031	FLT91031	FLT9500HP	-	-		68
591032	FLT91032	FLT9500HP	-	-		44
591033	FLT91033	FLT9500HP	-	-		68
591034	FLT91034	FLT9500HP	-	-		44
591035	FLT91035	FLT9500HP	-	-		19
591036	FLT91036	FLT9500HP	-	-		45
591037	FLT91037	FLT9500HP	-	-		68
591038	FLT91038	FLT9500HP	-	-		19
790xxx						
790000	FLT90000	FLT7500HP	-	-		41
790001	FLT90001	FLT7500HP	-	-		41
790002	FLT90002	FLT7500HP	-	-		41
790003	FLT90003	FLT7500HP	-	-		67
790004	FLT90004	FLT7500HP	-	-		67
790005	FLT90005	FLT7500HP	-	-		17
790007	FLT90007	FLT7500HP	-	-		17
790008	FLT90008	FLT7500HP	-	-		41
790009	FLT90009	FLT7500HP	-	-		67
790010	FLT90010	FLT7500HP	-	-		41
790011	FLT90011	FLT7500HP	-	-		67
790012	FLT90012	FLT7500HP	-	-		41
790013	FLT90013	FLT7500HP	-	-		41
790014	FLT90014	FLT7500HP	-	-		17
790015	FLT90015	FLT7500HP	-	-		17
790016	FLT90016	FLT7500HP	-	-		41

Mfr. Part #	FLT On/Off	On/Off Kit	FLT 2-Speed	2-Speed Kit	Also Use	Pg. #
790017	FLT90017	FLT7500HP	-	-		42
790018	FLT90018	FLT7500HP	-	-		67
790019	FLT90019	FLT7500HP	-	-		67
790020	FLT90020	FLT7500HP	-	-		67
790021	FLT90021	FLT7500HP	-	-		42
790022	FLT90022	FLT7500HP	-	-		17
790023	FLT90023	FLT7500HP	-	-		42
790024	FLT90024	FLT7500HP	-	-		42
790025	FLT90025	FLT7500HP	-	-		42
790026	FLT90026	FLT7500HP	-	-		-
790027	FLT90027	FLT7500HP	-	-		42
790028	FLT90028	FLT7500HP	-	-		17
790029	FLT90029	FLT7500HP	-	-		67
790030	FLT90030	FLT7500HP	-	-		17
790031	FLT90031	FLT7500HP	-	-		42
790032	FLT90032	FLT7500HP	-	-		42
791xxx						
791000	FLT91000	FLT9500HP	-	-		43
791001	FLT91001	FLT9500HP	-	-		43
791002	FLT91002	FLT9500HP	-	-		17
791003	FLT91003	FLT9505SP	-	-		18
791004	FLT91004	FLT9500HP	-	-		43
791005	FLT91005	FLT9500HP	-	-		18
791006	FLT91006	FLT9500HP	-	-		43
791007	FLT91007	FLT9500HP	-	-		18
791008	FLT91008	FLT9500HP	-	-		18
791009	FLT91009	FLT9500HP	-	-		43
791010	FLT91010	FLT9500HP	-	-		43
791011	FLT91011	FLT9500HP	-	-		68
791012	FLT91012	FLT9500HP	-	-		18
791013	FLT91013	FLT9500HP	-	-		18
791014	FLT91014	FLT9500HP	-	-		18
791015	FLT91015	FLT9500HP	-	-		18
791016	FLT91016	FLT9500HP	-	-		43
791017	FLT91017	FLT9505SP	-	-		19
791018	FLT91018	FLT9500HP	-	-		43
791019	FLT91019	FLT9500HP	-	-		44
791020	FLT91020	FLT9500HP	-	-		19
791021	FLT91021	FLT9500HP	-	-		44
791022	FLT91022	FLT9500HP	-	-		44
791023	FLT91023	FLT9500HP	-	-		68
791024	FLT91024	FLT9500HP	-	-		68
791025	FLT91025	FLT9500HP	-	-		19
791026	FLT91026	FLT9500HP	-	-		44
791027	FLT91027	FLT9500HP	-	-		19
791028	FLT91028	FLT9500HP	-	-		19
791029	FLT91029	FLT9500HP	-	-		44
791030	FLT91030	FLT9500HP	-	-		44
791031	FLT91031	FLT9500HP	-	-		68
791032	FLT91032	FLT9500HP	-	-		44
791033	FLT91033	FLT9500HP	-	-		68
791034	FLT91034	FLT9500HP	-	-		44
791035	FLT91035	FLT9500HP	-	-		19
791036	FLT91036	FLT9500HP	-	-		45
791037	FLT91037	FLT9500HP	-	-		68
791038	FLT91038	FLT9500HP	-	-		19
791039	FLT91039	FLT9500HP	-	-		82
791040	FLT91040	FLT9500HP	-	-		82
791041	FLT91041	FLT9500HP	-	-		82
791042	FLT91042	FLT9500HP	-	-		78
791043	FLT91043	FLT9500HP	-	-		78
791044	FLT91044	FLT9500HP	-	-		45
791045	FLT91045	FLT9500HP	-	-		45
791046	FLT91046	FLT9500HP	-	-		68
791047	FLT91047	FLT9500HP	-	-		68
791048	FLT91048	FLT9500HP	-	-		19
791049	FLT91049	FLT9500HP	-	-		20
791050	FLT91050	FLT9500HP	-	-		69
791051	FLT91051	FLT9500HP	-	-		20
791052	FLT91052	FLT9500HP	-	-		69
791054	FLT91054	FLT9500HP	-	-		45
791055	FLT91055	FLT9500HP	-	-		45
791056	FLT91056	FLT9500HP	-	-		45
791057	FLT91057	FLT9500HP	-	-		20
791058	FLT91058	FLT9500HP	-	-		45

Cross Reference Horton-style compatible

Mfr. Part #	Fleetrite On/Off	On/Off Kit	FLT 2-Speed	2-Speed Kit	Also Use	Pg. #
791059	FLT91059	FLT9500HP	-	-		20
791060	FLT91060	FLT9500HP	-	-		20
791061	FLT91061	FLT9500HP	-	-		45
791062	FLT91062	FLT9506HP	-	-		69
791063	FLT91063	FLT9500HP	-	-		20
791064	FLT91064	FLT9500HP	-	-		46
791065	FLT91024	FLT9500HP	-	-		68
791066	FLT91066	FLT9500HP	-	-		20
791067	FLT91067	FLT9500HP	-	-		20
791068	FLT91068	FLT9500HP	-	-		21
791069	FLT91069	FLT9500HP	-	-		21
791070	FLT91070	FLT9500HP	-	-		21
791071	FLT91071	FLT9500HP	-	-		21
791072	FLT91072	FLT9500HP	-	-		46
791073	FLT91073	FLT9500HP	-	-		46
791074	FLT91074	FLT9500HP	-	-		46
791075	FLT91075	FLT9500HP	-	-		46
791076	FLT91076	FLT9500HP	-	-		21
791077	FLT91077	FLT9500HP	-	-		69
791078	FLT91078	FLT9500HP	-	-		46
791079	FLT91079	FLT9500HP	-	-		46
791080	FLT91080	FLT9500HP	-	-		46
791081	FLT91081	FLT9500HP	-	-		21
791082	FLT91082	FLT9500HP	-	-		21
791083	FLT91083	FLT9500HP	-	-		69
791084	FLT91084	FLT9500HP	-	-		86
791085	FLT91085	FLT9500HP	-	-		21
791086	FLT91086	FLT9500HP	-	-		47
791087	FLT91087	FLT9500HP	-	-		22
791088	FLT91088	FLT9500HP	-	-		47
791089	FLT91089	FLT9500HP	-	-		22
791090	FLT91090	FLT9500HP	-	-		22
791091	FLT91091	FLT9500HP	-	-		69
791092	FLT91092	FLT9500HP	-	-		47
791093	FLT91093	FLT9504HP	-	-		47
791094	FLT91094	FLT9500HP	-	-		47
791095	FLT91095	FLT9500HP	-	-		47
791096	FLT91096	FLT9500HP	-	-		47
791097	FLT91097	FLT9500HP	-	-		22
791098	FLT91098	FLT9500HP	-	-		22
791099	FLT91099	FLT9500HP	-	-		47
791100	FLT91100	FLT9500HP	-	-		48
791101	FLT91101	FLT9500HP	-	-		48
791102	FLT91102	FLT9500HP	-	-		22
791103	FLT91103	FLT9500HP	-	-		48
791104	FLT91104	FLT9500HP	-	-		48
791105	FLT91105	FLT9500HP	-	-		69
791106	FLT91106	FLT9500HP	-	-		22
791107	FLT91107	FLT9500HP	-	-		70
791108	FLT91108	FLT9500HP	-	-		48
791109	FLT91109	FLT9500HP	-	-		48
791110	FLT91110	FLT9500HP	-	-		48
791111	FLT91111	FLT9500HP	-	-		48
791112	FLT91112	FLT9500HP	-	-		49
791113	FLT91113	FLT9500HP	-	-		49
791114	FLT91114	FLT9500HP	-	-		70
791115	FLT91115	FLT9505SP	-	-		22
791116	FLT91116	FLT9500HP	-	-		23
791125	FLT91027	FLT9500HP	-	-		19
791129	FLT91129	FLT9500HP	-	-		-
798xxx						
798003	FLT228005	-	-	-		-
798004	FLT228006	-	-	-		-
798162	-	-	FLT996272	FLT242561		-
799xxx						
799004	FLT99004	FLT14256	FLT990042	FLT24256		49
799005	FLT99005	FLT14256	FLT990052	FLT24256		49
799006	FLT99006	FLT14200	FLT990062	FLT24-200		71
799011	FLT99011	FLT142561	FLT990112	FLT242561		50
799011-2	-	-	FLT990112	FLT242561		50
799012	FLT99012	FLT14256	FLT990122	FLT24256		23
799019	FLT99019	FLT14256	FLT990192	FLT24256		86
799023	FLT99023	FLT14256	FLT990232	FLT24256		78
799024	FLT99024	FLT14256	FLT990242	FLT24256		78
799027	FLT99027	FLT14256	FLT990272	FLT24256	FLT250SK	71

Mfr. Part #	FLT On/Off	On/Off Kit	FLT 2-Speed	2-Speed Kit	Also Use	Pg. #
799030	FLT99030	FLT142561	FLT990302	FLT242561		50
799037	FLT99037	FLT14256	FLT990372	FLT24256		24
799039	FLT99039	FLT14256	FLT990392	FLT24256		-
799040	FLT99040	FLT14256	FLT990402	FLT24256		-
799041	FLT99041	FLT14256	FLT990412	FLT24256		72
799044	FLT99044	FLT14256	FLT990442	FLT24256		24
799047	FLT99097	FLT14256	FLT990972	FLT24256		53
799049	FLT99049	FLT14256	FLT990492	FLT24256		72
799052	FLT99052	FLT14256	FLT990522	FLT24256		51
799057	FLT99057	FLT14256	FLT990572	FLT24256		52
799065	FLT99065	FLT14256	FLT990652	FLT24256		73
799067	FLT99067	FLT14256	FLT990672	FLT24256		-
799068	FLT99068	FLT14256	FLT990682	FLT24256		24
799070	FLT99070	FLT14256	FLT990702	FLT24256		24
799073	FLT99073	FLT14256	FLT990732	FLT24256		25
799074	FLT99074	FLT14256	FLT990742	FLT24256		25
799077	FLT99077	FLT142561	FLT990772	FLT242561		83
799077-2	-	-	FLT990772	FLT242561		83
799078	FLT99078	FLT14256	FLT990782	FLT24256		25
799079	FLT99079	FLT14256	FLT990792	FLT24256		25
799082	FLT99082	FLT14256	FLT990822	FLT24256		52
799084	FLT99084	FLT14256	FLT990842	FLT24256		26
799090	FLT99090	FLT14256	FLT990902	FLT24256		53
799098	FLT99098	FLT14256	FLT990982	FLT24256		26
799103	FLT99103	FLT14256	FLT991032	FLT24256		26
799128	FLT99128	FLT14256	FLT991282	FLT24256		55
799131	FLT99131	FLT14256	FLT991312	FLT24256		56
799142	FLT99142	FLT142561	FLT991422	FLT242561		83
799142-2	-	-	FLT991422	FLT242561		83
799143	FLT99143	FLT142561	FLT991432	FLT242561		83
799154	FLT99154	FLT14256	FLT991542	FLT24256		56
799161	FLT99161	FLT14256	FLT991612	FLT24256		27
799168	FLT99168	FLT14256	FLT991682	FLT24256		28
799189	FLT99189	FLT14256	FLT991892	FLT24256		58
799191	FLT99191	FLT14256	FLT991912	FLT24256	FLT300SK	74
799205	FLT99205	FLT14256	FLT992052	FLT24256		58
799223	FLT99223	FLT14256	FLT992232	FLT24256		59
799233	FLT99233	FLT142561	FLT992332	FLT242561		59
799238	FLT99238	FLT14256	FLT992382	FLT24256		75
799263	FLT99263	FLT14256	FLT992632	FLT24256		30
799285	FLT99285	FLT14256	FLT992852	FLT24256		24
799291	FLT99291	FLT14256	FLT992912	FLT24256	FLT300SK	30
799292	FLT99070	FLT14256	FLT990702	FLT24256		24
799298	FLT99298	FLT14256	FLT992982	FLT24256		30
799300	FLT99300	FLT14256	FLT993002	FLT24256		76
799306	FLT99306	FLT14256	FLT993062	FLT24256		60
799311	FLT99311	FLT142561	FLT993112	FLT242561		30
799311-2	-	-	FLT993112	FLT242561		30
799313	FLT99313	FLT14256	FLT993132	FLT24256		31
799316	FLT99316	FLT14256	FLT993162	FLT24256		31
799317	FLT99317	FLT14256	FLT993172	FLT24256		31
799318	FLT99318	FLT14256	FLT993182	FLT24256		31
799323	FLT99298	FLT14256	FLT992982	FLT24256		30
799326	FLT99326	FLT14256	FLT993262	FLT24256	FLT250SK	61
799333	FLT99333	FLT14256	FLT993332	FLT24256		32
799334	FLT99334	FLT14256	FLT993342	FLT24256		32
799336	FLT99336	FLT142561	FLT993362	FLT242561		84
799336-2	-	-	FLT993362	FLT242561		84
799339	FLT99339	FLT142561	FLT993392	FLT242561		32
799341	FLT99341	FLT142561	FLT993412	FLT242561		32
799341-2	-	-	FLT993412	FLT242561		32
799346	FLT99346	FLT14256	FLT993462	FLT24256		32
799360	FLT99360	FLT14256	FLT993602	FLT24256		33
799381	FLT99381	FLT14256	FLT993812	FLT24256		84
799410	FLT99410	FLT14256	FLT994102	FLT24256		76
799455-2	-	-	FLT994552	FLT242561		84
799465	FLT99465	FLT14256	FLT994652	FLT24256		86
799466	FLT99466	FLT14256	FLT994662	FLT24256		63
799491	FLT99247	FLT14256	FLT992472	FLT24256		80
799492	FLT99492	FLT14256	FLT994922	FLT24256		80
799493	FLT99493	FLT14256	FLT994932	FLT24256		80
799494	FLT99494	FLT14256	FLT994942	FLT24256		80
799495	FLT99495	FLT14256	FLT994952	FLT24256		80
799496	FLT99423	FLT14256	FLT994232	FLT24256		80
799497	FLT99407	FLT14256	FLT994072	FLT24256		80

Mfr. Part #	Fleetrite On/Off	On/Off Kit	FLT 2-Speed	2-Speed Kit	Also Use	Pg. #
799498	FLT99498	FLT14256	FLT994982	FLT24256		81
799499	FLT99499	FLT14256	FLT994992	FLT24256		81
799504	FLT99504	FLT142561	FLT995042	FLT242561		-
799504-2	-	-	FLT995042	FLT242561		-
799801	FLT99801	FLT14256	FLT998012	FLT24256		64
799807	FLT99807	FLT142561	FLT998072	FLT242561		64
799807-2	-	-	FLT998072	FLT242561		64
799843	FLT99843	FLT142561	FLT998432	FLT242561		84
799843-2	-	-	FLT998432	FLT242561		84
799850	FLT99850	FLT14256	FLT998502	FLT24256		77
799853	FLT99853	FLT142561	FLT998532	FLT242561		-
799853-2	-	-	FLT998532	FLT242561		-
799899	FLT99899	FLT142561	FLT998992	FLT242561		40
799899-2	-	-	FLT998992	FLT242561		43
799915	-	-	FLT993392	FLT242561		-
79Axxxx						
79A8104	-	-	FLT995582	FLT24256		-
79A8105	-	-	FLT997542	FLT24256		-
79A8107	-	-	FLT997562	FLT24256		-
79A8110	-	-	FLT995952	FLT24256		-
79A8121	-	-	FLT981212	FLT24256		-
79A8125	-	-	FLT997912	FLT24256		-
79A8131	FLT99580	FLT14256	FLT995802	FLT24256		-
79A8131-2	-	-	FLT995802	FLT24256		-
79A8177	-	-	FLT997882	FLT24256		-
79A8181	-	-	FLT995582	FLT24256		-
79A8182	-	-	FLT997542	FLT24256		-
79A8183	-	-	FLT997552	FLT24256		-
79A8184	-	-	FLT997562	FLT24256		-
79A8187	-	-	FLT996632	FLT24256		-
79A8189	-	-	FLT996492	FLT24256		-
79A8202	-	-	FLT997822	FLT24256		-
79A8210	-	-	FLT986542	FLT24256		-
79A8600	FLT98600	FLT14256	FLT986002	FLT24256		49
79A8601	FLT98601	FLT14256	FLT986012	FLT24256		49
79A8601-2	-	-	FLT986012	FLT24256		-
79A8606-2	-	-	FLT986062	FLT24256		78
79A8607-2	-	-	FLT986072	FLT24256		-
79A8609	FLT98609	FLT14256	FLT986092	FLT24256		-
79A8611	FLT98611	FLT14256	FLT986112	FLT24256		-
79A8616-2	-	-	FLT986162	FLT24256		-
79A8618	FLT98618	FLT14256	FLT986182	FLT24256		-
79A8618-2	-	-	FLT986182	FLT24256		-
79A8621	FLT98621	FLT14256	FLT986212	FLT24256		70
79A8621-2	-	-	FLT986212	FLT24256		70
79A8629-2	-	-	FLT986292	FLT24256		-
79A8648	FLT98648	FLT14256	FLT986482	FLT24256		-
79A8650	FLT98650	FLT14256	FLT986502	FLT24256		70
79A8652	FLT98652	FLT14256	FLT986522	FLT24256		-
79A8652-2	-	-	FLT986522	FLT24256		-
79A8653	FLT98653	FLT14256	FLT986532	FLT24256		-
79A8653-2	-	-	FLT986532	FLT24256		-
79A8656	FLT98656	FLT14256	FLT986562	FLT24256		-
79A8657	FLT98657	FLT14256	FLT986572	FLT24256		-
79A8657-2	-	-	FLT986572	FLT24256		-
79A9004	FLT99004	FLT14256	FLT990042	FLT24256		49
79A9005	FLT99005	FLT14256	FLT990052	FLT24256		49
79A9007	FLT99007	FLT14256	FLT990072	FLT24256		71
79A9012	FLT99012	FLT14256	FLT990122	FLT24256		23
79A9019	FLT99019	FLT14256	FLT990192	FLT24256		86
79A9019-2	-	-	FLT990192	FLT24256		86
79A9023	FLT99023	FLT14256	FLT990232	FLT24256		78
79A9023-2	-	-	FLT990232	FLT24256		78
79A9026	FLT99026	FLT14256	FLT990262	FLT24256		50
79A9027	FLT99027	FLT14256	FLT990272	FLT24256	FLT250SK	71
79A9034	FLT99034	FLT14256	FLT990342	FLT24256		24
79A9034-2	-	-	FLT990342	FLT24256		24
79A9036	FLT99036	FLT14256	FLT990362	FLT24256		50
79A9037	FLT99037	FLT14256	FLT990372	FLT24256		24
79A9038	FLT99038	FLT14256	FLT990382	FLT24256		24
79A9041	FLT99041	FLT14256	FLT990412	FLT24256		72
79A9041-2	-	-	FLT990412	FLT24256		72
79A9044	FLT99044	FLT14256	FLT990442	FLT24256		24
79A9049	FLT99049	FLT14256	FLT990492	FLT24256		72
79A9050	FLT99050	FLT14256	FLT990502	FLT24256		51

Mfr. Part #	FLT On/Off	On/Off Kit	FLT 2-Speed	2-Speed Kit	Also Use	Pg. #
79A9054	FLT99054	FLT14256	FLT990542	FLT24256		51
79A9054-2	-	-	FLT990542	FLT24256		51
79A9057	FLT99057	FLT14256	FLT990572	FLT24256		52
79A9062-2	-	-	FLT990622	FLT24256		72
79A9064	FLT99064	FLT14256	FLT990642	FLT24256		72
79A9064-2	-	-	FLT990642	FLT24256		72
79A9065	FLT99065	FLT14256	FLT990652	FLT24256		73
79A9065-2	-	-	FLT990652	FLT24256		73
79A9067	FLT99067	FLT14256	FLT990672	FLT24256		-
79A9067-2	-	-	FLT990672	FLT24256		-
79A9068	FLT99068	FLT14256	FLT990682	FLT24256		24
79A9068-2	-	-	FLT990682	FLT24256		24
79A9073	FLT99073	FLT14256	FLT990732	FLT24256		25
79A9074	FLT99074	FLT14256	FLT990742	FLT24256		25
79A9074-2	-	-	FLT990742	FLT24256		25
79A9079	FLT99079	FLT14256	FLT990792	FLT24256		25
79A9084	FLT99084	FLT14256	FLT990842	FLT24256		26
79A9090	FLT99090	FLT14256	FLT990902	FLT24256		53
79A9092	FLT99092	FLT14256	FLT990922	FLT24256		73
79A9093	FLT99093	FLT14256	FLT990932	FLT24256		73
79A9096	FLT99096	FLT14256	FLT990962	FLT24256		52
79A9098	FLT99098	FLT14256	FLT990982	FLT24256		26
79A9098-2	-	-	FLT990982	FLT24256		26
79A9100	FLT99100	FLT14256	FLT991002	FLT24256		-
79A9103	FLT99103	FLT14256	FLT991032	FLT24256		26
79A9108	FLT99108	FLT14256	FLT991082	FLT24256		53
79A9110	FLT99110	FLT14256	FLT991102	FLT24256	FLT350SK	54
79A9113	FLT99113	FLT14256	FLT991132	FLT24256		54
79A9128-2	-	-	FLT991282	FLT24256		55
79A9131	FLT99131	FLT14256	FLT991312	FLT24256		56
79A9132	FLT99132	FLT14256	FLT991322	FLT24256		56
79A9133-2	-	-	FLT991332	FLT24256		56
79A9134-2	-	-	FLT991342	FLT24256		56
79A9154-2	-	-	FLT991542	FLT24256		56
79A9157	FLT99157	FLT14256	FLT991572	FLT24256		26
79A9161	FLT99161	FLT14256	FLT991612	FLT24256		27
79A9162-2	-	-	FLT991622	FLT24256		27
79A9164	FLT99164	FLT14256	FLT991642	FLT24256		27
79A9165	FLT99165	FLT14256	FLT991652	FLT24256		-
79A9166	FLT99166	FLT14256	FLT991662	FLT24256		-
79A9168	FLT99168	FLT14256	FLT991682	FLT24256		57
79A9168-2	-	-	FLT991682	FLT24256		57
79A9173	FLT99173	FLT14256	FLT991732	FLT24256		27
79A9190	FLT99190	FLT14256	FLT991902	FLT24256		28
79A9190-2	-	-	FLT991902	FLT24256		28
79A9191	FLT99191	FLT14256	FLT991912	FLT24256	FLT300SK	28
79A9205	FLT99205	FLT14256	FLT992052	FLT24256		58
79A9206	-	-	FLT992062	FLT24256		-
79A9222	FLT99222	FLT14256	FLT992222	FLT24256		74
79A9222-2	-	-	FLT992222	FLT24256		74
79A9223	FLT99223	FLT14256	FLT992232	FLT24256		74
79A9223-2	-	-	FLT992232	FLT24256		74
79A9232	FLT99232	FLT14256	FLT992322	FLT24256		58
79A9238	FLT99238	FLT14256	FLT992382	FLT24256		59
79A9238-2	-	-	FLT992382	FLT24256		59
79A9241	FLT99241	FLT14256	FLT992412	FLT24256		29
79A9254	FLT99254	FLT14256	FLT992542	FLT24256		-
79A9256	FLT99256	FLT14256	FLT992562	FLT24256	FLT300SK	75
79A9261	FLT99261	FLT14256	FLT992612	FLT24256		-
79A9261-2	-	-	FLT992612	FLT24256		-
79A9263	FLT99263	FLT14256	FLT992632	FLT24256		59
79A9263-2	-	-	FLT992632	FLT24256		59
79A9268	FLT99268	FLT14256	FLT992682	FLT24256		75
79A9285	FLT99285	FLT14256	FLT992852	FLT24256		75
79A9285-2	-	-	FLT992852	FLT24256		75
79A9291	FLT99291	FLT14256	FLT992912	FLT24256	FLT300SK	30
79A9292	FLT99070	FLT14256	FLT990702	FLT24256		24
79A9292-2	-	-	FLT990702	FLT24256		24
79A9295	FLT99295	FLT14256	FLT992952	FLT24256		60
79A9295-2	-	-	FLT992952	FLT24256		60
79a9296	FLT99296	FLT14256	FLT992962	FLT24256		60
79A9298	FLT99298	FLT14256	FLT992982	FLT24256		30
79A9298-2	-	-	FLT992982	FLT24256		30
79A9300	FLT99300	FLT14256	FLT993002	FLT24256		76
79A9303	FLT99303	FLT14256	FLT993032	FLT24256		-

Cross Reference Horton-style compatible

Mfr. Part #	Fleetrite On/Off	On/Off Kit	FLT 2-Speed	2-Speed Kit	Also Use	Pg. #
79A9305	FLT99305	FLT14200	FLT993052	FLT24-200		76
79A9306	FLT99306	FLT14256	FLT993062	FLT24256		60
79a9306-2	-	-	FLT993062	FLT24256		60
79A9313	FLT99313	FLT14256	FLT993132	FLT24256		31
79A9313-2	-	-	FLT993132	FLT24256		31
79A9316	FLT99316	FLT14256	FLT993162	FLT24256		31
79A9317	FLT99317	FLT14256	FLT993172	FLT24256		31
79A9317-2	-	-	FLT993172	FLT24256		31
79A9318	FLT99318	FLT14256	FLT993182	FLT24256		31
79A9318-2	-	-	FLT993182	FLT24256		31
79A9319	FLT99319	FLT14256	FLT993192	FLT24256		31
79A9319-2	-	-	FLT993192	FLT24256		31
79A9323	FLT99298	FLT14256	FLT992982	FLT24256		30
79A9324	FLT99324	FLT14256	FLT993242	FLT24256		61
79A9326	FLT99326	FLT14256	FLT993262	FLT24256	FLT250SK	61
79A9326-2	-	-	FLT993262	FLT24256	FLT250SK	61
79A9327	FLT99327	FLT14256	FLT993272	FLT24256		31
79A9332-2	-	-	FLT993322	FLT24256		-
79A9333	FLT99333	FLT14256	FLT993332	FLT24256		32
79A9333-2	-	-	FLT993332	FLT24256		32
79A9334	FLT99334	FLT14256	FLT993342	FLT24256		32
79A9334-2	-	-	FLT993342	FLT24256		32
79A9335-2	-	-	FLT993352	FLT24256		-
79A9346	FLT99346	FLT14256	FLT993462	FLT24256		32
79A9346-2	-	-	FLT993462	FLT24256		32
79A9349-2	-	-	FLT993492	FLT24256		61
79A9360	FLT99360	FLT14256	FLT993602	FLT24256		33
79A9361	FLT99361	FLT14256	FLT993612	FLT24256		33
79A9361-2	-	-	FLT993612	FLT24256		33
79A9362	FLT99362	FLT14256	FLT993622	FLT24256		33
79A9366	FLT99366	FLT14256	FLT993662	FLT24256		33
79A9381	FLT99381	FLT14256	FLT993812	FLT24256		84
79A9382	FLT99382	FLT14256	FLT993822	FLT24256		34
79A9385-2	-	-	FLT993852	FLT24256		-
79A9389-2	-	-	FLT993892	FLT24256		62
79A9410	FLT99410	FLT14256	FLT994102	FLT24256		76
79A9410-2	-	-	FLT994102	FLT24256		76
79A9415-2	-	-	FLT994152	FLT24256		62
79A9416-2	-	-	FLT994162	FLT24256		-
79A9421	FLT99421	FLT14256	FLT994212	FLT24256		35
79A9428	FLT99428	FLT14256	FLT994282	FLT24256		36
79A9428-2	-	-	FLT994282	FLT24256		36
79A9434-2	-	-	FLT994342	FLT24256		-
79A9436-2	-	-	FLT992792	FLT24256		29
79A9437	FLT99346	FLT14256	FLT993462	FLT24256		32
79A9440-2	-	-	FLT994402	FLT24256		36
79A9457	FLT99457	FLT14256	FLT994572	FLT24256		36
79A9461-2	-	-	FLT994612	FLT24256		-
79A9465	FLT99465	FLT14256	FLT994652	FLT24256		86
79A9465-2	-	-	FLT994652	FLT24256		86
79A9466	FLT99466	FLT14256	FLT994662	FLT24256		63
79A9466-2	-	-	FLT994662	FLT24256		63
79A9487-2	-	-	FLT994872	FLT24256		80
79A9491	FLT99247	FLT14256	FLT992472	FLT24256		80
79A9491-2	-	-	FLT992472	FLT24256		80
79A9492	FLT99492	FLT14256	FLT994922	FLT24256		80
79A9492-2	-	-	FLT994922	FLT24256		80
79A9493	FLT99493	FLT14256	FLT994932	FLT24256		80
79A9494-2	-	-	FLT994942	FLT24256		80
79A9495-2	-	-	FLT994952	FLT24256		80
79A9496	FLT99423	FLT14256	FLT994232	FLT24256		80
79A9497	FLT99497	FLT14256	FLT994972	FLT24256		81
79A9498-2	-	-	FLT994982	FLT24256		81
79A9502-2	-	-	FLT995022	FLT24256		-
79A9508-2	-	-	FLT995082	FLT24256		-
79A9509-2	-	-	FLT995092	FLT24256	FLT300SK	63
79A9512-2	-	-	FLT995022	FLT24256		51
79A9515	FLT99188	FLT14256	FLT991882	FLT24256		57
79A9515-2	-	-	FLT991882	FLT24256		57
79A9530-2	-	-	FLT995302	FLT24256		-
79A9539-2	-	-	FLT995392	FLT24256		-
79A9553-2	-	-	FLT995532	FLT24256		-
79A9554-2	-	-	FLT995542	FLT24256		-
79A9560	FLT99560	FLT14256	FLT995602	FLT24256		-
79A9562-2	-	-	FLT995622	FLT24256		78

Mfr. Part #	FLT On/Off	On/Off Kit	FLT 2-Speed	2-Speed Kit	Also Use	Pg. #
79A9569	FLT99569	FLT14256	FLT995692	FLT24256		-
79A9581	FLT99581	FLT14256	FLT995812	FLT24256		-
79A9581-2	-	-	FLT995812	FLT24256		-
79A9586	FLT99586	FLT14-500	FLT995862	FLT24256		-
79A9589	FLT99589	FLT14-500	FLT995892	FLT24256		-
79A9590	FLT99590	FLT14-500	FLT995902	FLT24256		85
79A9591	FLT99591	FLT14-500	FLT995912	FLT24256		-
79A9592	FLT99592	FLT14-500	FLT995922	FLT24256		85
79A9594	FLT99594	FLT14-500	FLT995942	FLT24256		-
79A9595	FLT99595	FLT14-500	FLT995952	FLT24256		-
79A9625	-	-	FLT999702	FLT24256		79
79A9637	FLT99637	FLT14-500	FLT996372	FLT24256		-
79A9638	FLT99638	FLT14-500	FLT996382	FLT24256		-
79A9639	FLT99639	FLT14-500	FLT996392	FLT24256	FLT200SK	-
79A9640	FLT99640	FLT14-500	FLT996402	FLT24256	FLT200SK	-
79A9643-2	-	-	FLT996432	FLT24256		-
79A9644	FLT99552	FLT14256	FLT995522	FLT24256		-
79A9644-2	-	-	FLT995522	FLT24256		-
79A9645	FLT99553	FLT14256	FLT995532	FLT24256		-
79A9645-2	-	-	FLT995532	FLT24256		-
79A9646	FLT99554	FLT14256	FLT995542	FLT24256		-
79A9646-2	-	-	FLT995542	FLT24256		-
79A9647	FLT99647	FLT14-500	FLT996472	FLT24256		-
79A9649	FLT99649	FLT14-500	FLT996492	FLT24256		-
79A9649	FLT99649	FLT14256	FLT996492	FLT24256		-
79A9659	FLT99586	FLT14-500	FLT995862	FLT24256		-
79A9660	FLT99589	FLT14-500	FLT995892	FLT24256		-
79A9737	-	-	FLT986562	FLT24256		-
79A9740	-	-	FLT995602	FLT24256		-
79A9746	-	-	FLT986502	FLT24256		70
79A9748	-	-	FLT997482	FLT24256		-
79A9749	-	-	FLT986092	FLT24256		-
79A9750	-	-	FLT998332	FLT24256		-
79A9757	-	-	FLT997572	FLT24256		79
79A9760	-	-	FLT997602	FLT24256		-
79A9761	-	-	FLT995902	FLT24256		85
79A9762	-	-	FLT995922	FLT24256		85
79A9763	-	-	FLT995912	FLT24256		-
79A9764	-	-	FLT997642	FLT24256		-
79A9766	-	-	FLT997662	FLT24256		-
79A9768	-	-	FLT995942	FLT24256		-
79A9777	-	-	FLT996392	FLT24256	FLT200SK	-
79A9781	-	-	FLT997812	FLT24256		-
79A9782	-	-	FLT997822	FLT24256		-
79A9788	-	-	FLT997882	FLT24256		-
79A9789	-	-	FLT997892	FLT24256		-
79A9790	-	-	FLT997902	FLT24256		-
79A9791	-	-	FLT997912	FLT24256		-
79A9793	-	-	FLT997932	FLT24256		-
79A9797	-	-	FLT996432	FLT24256		-
79A9798	-	-	FLT995892	FLT24256		-
79A9801	FLT99801	FLT14256	FLT998012	FLT24256		64
79A9809	FLT99809	FLT14256	FLT998092	FLT24256		37
79A9809-2	-	-	FLT998092	FLT24256		37
79A9815	FLT99815	FLT14256	FLT998152	FLT24256		37
79A9815-2	-	-	FLT998152	FLT24256		37
79A9818	FLT99818	FLT14256	FLT998182	FLT24256		38
79A9818-2	-	-	FLT998182	FLT24256		38
79A9820-2	-	-	FLT998202	FLT24256		63
79A9823	FLT99823	FLT14256	FLT998232	FLT24256		64
79A9823-2	-	-	FLT998232	FLT24256		64
79A9833	FLT99833	FLT14256	FLT998332	FLT24256		-
79A9845-2	-	-	FLT998452	FLT24256		65
79A9847	-	-	FLT998472	FLT24256		65
79A9849-2	-	-	FLT998492	FLT24256		77
79A9850	FLT99850	FLT14256	FLT998502	FLT24256		77
79A9854	FLT99854	FLT14256	FLT998542	FLT24256		-
79A9857	FLT99857	FLT14256	FLT998572	FLT24256		-
79A9857-2	-	-	FLT998572	FLT24256		-
79A9861-2	-	-	FLT998612	FLT24256		-
79A9897	FLT99897	FLT14256	FLT998972	FLT24256		66
79A9897-2	-	-	FLT998972	FLT24256		66
79A9898	FLT99834	FLT14256	FLT998342	FLT24256		38
79A9898-2	-	-	FLT998342	FLT24256		38
79A9906	-	-	FLT999002	FLT24256		40

Mfr. Part #	Fleetrite On/Off	On/Off Kit	FLT 2-Speed	2-Speed Kit	Also Use	Pg. #
79A9908	-	-	FLT993462	FLT24256	-	-
79A9916	-	-	FLT992612	FLT24256	-	-
79A9924	-	-	FLT992622	FLT24256	-	-
79A9946	-	-	FLT994992	FLT24256	-	81
79A9947	-	-	FLT994982	FLT24256	-	81
79A9954	-	-	FLT999542	FLT24256	-	81
79A9955	-	-	FLT999552	FLT24256	-	81
79A9993	-	-	FLT997222	FLT24256	-	-
79A9994	-	-	FLT997212	FLT24256	-	-
79A9996	-	-	FLT999962	FLT24256	-	-
79A9997	-	-	FLT999972	FLT24256	-	-
79A9998	-	-	FLT996782	FLT24256	-	-
8xxxxx						
809800	Use Kit	FLT7500HP	-	-	-	-
809803	FLT90023	FLT7500HP	-	-	-	42
809804	FLT91001	FLT9500HP	-	-	-	43
809806	Use Kit	FLT7500HP	-	-	-	-
809811	FLT90000	FLT7500HP	-	-	-	41
809812	Use Kit	FLT7500HP	-	-	-	-
809815	FLT90008	FLT7500HP	-	-	-	41
809823	FLT90001	FLT7500HP	-	-	-	41
809826	FLT90002	FLT7500HP	-	-	-	41
809829	Use Kit	FLT7500HP	-	-	-	-
809832	FLT90003	FLT7500HP	-	-	-	67
809835	Use Kit	FLT7500HP	-	-	-	-
809845	Use Kit	FLT7500HP	-	-	-	-
809849	FLT90011	FLT7500HP	-	-	-	67
809853	Use Kit	FLT7500HP	-	-	-	-
809854	FLT90004	FLT7500HP	-	-	-	67
809861	Use Kit	FLT7500HP	-	-	-	-
809864	Use Kit	FLT7500HP	-	-	-	-
809865	FLT90005	FLT7500HP	-	-	-	17
819803	FLT90023	FLT7500HP	-	-	-	42
819804	FLT90010	FLT7500HP	-	-	-	41
819806	Use Kit	FLT7500HP	-	-	-	-
819811	FLT90000	FLT7500HP	-	-	-	41
819812	Use Kit	FLT7500HP	-	-	-	-
819820	Use Kit	FLT7500HP	-	-	-	-
819823	FLT90001	FLT7500HP	-	-	-	41
819826	FLT90002	FLT7500HP	-	-	-	41
819829	Use Kit	FLT7500HP	-	-	-	-
819849	FLT90009	FLT7500HP	-	-	-	67
819853	Use Kit	FLT7500HP	-	-	-	-
819854	FLT90004	FLT7500HP	-	-	-	67
819855	Use Kit	FLT7500HP	-	-	-	-
819861	Use Kit	FLT7500HP	-	-	-	-
819865	FLT90005	FLT7500HP	-	-	-	17
819875	FLT91027	FLT9500HP	-	-	-	19
829826	Use Kit	FLT7500HP	-	-	-	-
829832	FLT90003	FLT7500HP	-	-	-	67
829839	Use Kit	FLT7500HP	-	-	-	-
829853	Use Kit	FLT7500HP	-	-	-	-
829854	FLT90004	FLT7500HP	-	-	-	67
829855	Use Kit	FLT7500HP	-	-	-	-
829861	Use Kit	FLT7500HP	-	-	-	-
829864	FLT90810	FLT94207	-	-	-	90808
839803	FLT90023	FLT7500HP	-	-	-	42
839806	Use Kit	FLT7500HP	-	-	-	-
839811	FLT90000	FLT7500HP	-	-	-	41
839812	Use Kit	FLT7500HP	-	-	-	-
839813	FLT90000	FLT7500HP	-	-	-	41
839822	Use Kit	FLT7500HP	-	-	-	-
839832	FLT90003	FLT7500HP	-	-	-	67
839854	FLT90004	FLT7500HP	-	-	-	67
839861	Use Kit	FLT7500HP	-	-	-	-
839864	FLT90810	FLT94207	-	-	-	-
839865	FLT90005	FLT7500HP	-	-	-	17
839874	FLT91005	FLT9500HP	-	-	-	18
843826	FLT90002	FLT7500HP	-	-	-	41
849803	FLT90010	FLT7500HP	-	-	-	41
849812	FLT91000	FLT9500HP	-	-	-	43
849813	FLT91016	FLT9500HP	-	-	-	43
849822	Use Kit	FLT7500HP	-	-	-	-
849874	Use Kit	FLT7500HP	-	-	-	-
859803	FLT91001	FLT9500HP	-	-	-	43

Mfr. Part #	FLT On/Off	On/Off Kit	FLT 2-Speed	2-Speed Kit	Also Use	Pg. #
859822	FLT91004	FLT9500HP	-	-	-	43
859865	FLT90005	FLT7500HP	-	-	-	17
859867	FLT91002	FLT9500HP	-	-	-	17
869811	FLT90000	FLT7500HP	-	-	-	41
869822	FLT91006	FLT9500HP	-	-	-	43
869823	FLT91010SP	FLT94207	-	-	-	-
869864	FLT90022	FLT7500HP	-	-	-	17
869865	FLT90007	FLT7500HP	-	-	-	17
879812	Use Kit	FLT7500HP	-	-	-	-
879823	FLT91010SP	FLT94207	-	-	-	-
879865	FLT90005	FLT7500HP	-	-	-	17
879867	FLT91002	FLT9500HP	-	-	-	17
889803	FLT90010	FLT7500HP	-	-	-	41
889812	Use Kit	FLT9500HP	-	-	-	-
889867	FLT91003	FLT9505SP	-	-	-	18
889874	Use Kit	FLT9500HP	-	-	-	-
899832	FLT90003	FLT7500HP	-	-	-	67
899865	FLT90007	FLT7500HP	-	-	-	17
899874	Use Kit	FLT9500HP	-	-	-	-
90xxxx						
900004	Use Kit	FLT7500HP	-	-	-	-
900006	FLT90004	FLT7500HP	-	-	-	67
98xxxx						
980003	FLT90000	FLT7500HP	-	-	-	41
980004	Use Kit	FLT7500HP	-	-	-	-
980005	Use Kit	FLT7500HP	-	-	-	-
980006	Use Kit	FLT7500HP	-	-	-	-
980007	Use Kit	FLT7500HP	-	-	-	-
980008	FLT90012	FLT7500HP	-	-	-	41
980009	FLT90005	FLT7500HP	-	-	-	17
980010	FLT90009	FLT7500HP	-	-	-	67
980011	FLT91115	FLT9500HP	-	-	-	22
980012	Use Kit	FLT7500HP	-	-	-	-
980013	FLT90013	FLT7500HP	-	-	-	41
980014	FLT90014	FLT7500HP	-	-	-	17
980015	FLT90009	FLT7500HP	-	-	-	67
980016	Use Kit	FLT7500HP	-	-	-	-
980017	FLT90015	FLT7500HP	-	-	-	17
980018	Use Kit	FLT7500HP	-	-	-	-
980019	Use Kit	FLT7500HP	-	-	-	-
980020	FLT91011	FLT9500HP	-	-	-	68
980021	Use Kit	FLT7500HP	-	-	-	-
980022	Use Kit	FLT7500HP	-	-	-	-
980023	FLT90014	FLT7500HP	-	-	-	17
980024	FLT90017	FLT7500HP	-	-	-	42
980025	Use Kit	FLT7500HP	-	-	-	-
980026	FLT90015	FLT7500HP	-	-	-	17
980027	FLT90016	FLT7500HP	-	-	-	41
980028	FLT90005	FLT7500HP	-	-	-	17
980029	Use Kit	FLT7500HP	-	-	-	-
980031	Use Kit	FLT7500HP	-	-	-	-
980032	Use Kit	FLT7500HP	-	-	-	-
980033	Use Kit	FLT7500HP	-	-	-	-
980036	FLT90014	FLT7500HP	-	-	-	17
980037	FLT90018	FLT7500HP	-	-	-	67
980038	Use Kit	FLT7500HP	-	-	-	-
980039	Use Kit	FLT7500HP	-	-	-	-
980040	FLT90002	FLT7500HP	-	-	-	41
980043	FLT90022	FLT7500HP	-	-	-	17
980044	FLT90019	FLT7500HP	-	-	-	67
980045	Use Kit	FLT7500HP	-	-	-	-
980046	Use Kit	FLT7500HP	-	-	-	-
980048	Use Kit	FLT7500HP	-	-	-	-
980049	FLT90021	FLT7500HP	-	-	-	42
980050	FLT90019	FLT7500HP	-	-	-	67
980051	FLT90021	FLT7500HP	-	-	-	42
980052	Use Kit	FLT7500HP	-	-	-	-
980053	Use Kit	FLT7500HP	-	-	-	-
980054	Use Kit	FLT7500HP	-	-	-	-
980055	FLT90017	FLT7500HP	-	-	-	42
980056	FLT90015	FLT7500HP	-	-	-	17
980057	Use Kit	FLT7500HP	-	-	-	-
980059	FLT90022	FLT7500HP	-	-	-	17
980060	FLT90010	FLT7500HP	-	-	-	41
980061	FLT90018	FLT7500HP	-	-	-	67

Cross Reference Horton-style compatible

Mfr. Part #	Fleetrite On/Off	On/Off Kit	FLT 2-Speed	2-Speed Kit	Also Use	Pg. #
980062	FLT90013	FLT7500HP	-	-		41
980063	FLT90017	FLT7500HP	-	-		42
980064	FLT90004	FLT7500HP	-	-		67
980065	Use Kit	FLT7500HP	-	-		-
980066	Use Kit	FLT7500HP	-	-		-
980067	FLT90014	FLT7500HP	-	-		17
980068	Use Kit	FLT7500HP	-	-		-
980069	FLT90002	FLT7500HP	-	-		41
980070	FLT90014	FLT7500HP	-	-		17
980071	FLT90015	FLT7500HP	-	-		17
980072	Use Kit	FLT7500HP	-	-		-
980073	FLT90023	FLT7500HP	-	-		42
980074	FLT90016	FLT7500HP	-	-		41
980075	Use Kit	FLT7500HP	-	-		-
980076	Use Kit	FLT7500HP	-	-		-
980077	FLT90012	FLT7500HP	-	-		41
980078	FLT90000	FLT7500HP	-	-		41
980079	Use Kit	FLT7500HP	-	-		-
980080	FLT90005	FLT7500HP	-	-		17
980081	FLT90007	FLT7500HP	-	-		17
980082	FLT90002	FLT7500HP	-	-		41
980083	Use Kit	FLT7500HP	-	-		-
980084	Use Kit	FLT7500HP	-	-		-
980085	FLT90003	FLT7500HP	-	-		67
980086	FLT90003	FLT7500HP	-	-		67
980087	FLT90009	FLT7500HP	-	-		67
980088	Use Kit	FLT7500HP	-	-		-
980089	Use Kit	FLT7500HP	-	-		-
980090	Use Kit	FLT7500HP	-	-		-
980091	FLT90008	FLT7500HP	-	-		41
980092	Use Kit	FLT7500HP	-	-		-
980093	FLT90001	FLT7500HP	-	-		41
980094	Use Kit	FLT7500HP	-	-		-
980095	Use Kit	FLT7500HP	-	-		-
980096	Use Kit	FLT7500HP	-	-		-
980097	FLT90010	FLT7500HP	-	-		41
980098	Use Kit	FLT7500HP	-	-		-
980099	FLT90013	FLT7500HP	-	-		41
980100	FLT90018	FLT7500HP	-	-		67
980101	Use Kit	FLT7500HP	-	-		-
980102	FLT90020	FLT7500HP	-	-		67
980103	Use Kit	FLT7500HP	-	-		-
980104	Use Kit	FLT7500HP	-	-		-
980105	FLT90004	FLT7500HP	-	-		67
980107	Use Kit	FLT7500HP	-	-		-
980108	Use Kit	FLT7500HP	-	-		-
981000	FLT91003	FLT9505SP	-	-		18
981001	FLT91027	FLT9500HP	-	-		19
981002	FLT91000	FLT9500HP	-	-		43
981003	FLT91103	FLT9500HP	-	-		48
981004	FLT91012	FLT9505SP	-	-		18
981005	FLT91015	FLT9500HP	-	-		18
981006	FLT91007	FLT9500HP	-	-		18
981007	FLT91008	FLT9500HP	-	-		18
981008	FLT91108	FLT9500HP	-	-		48
981009	FLT91000	FLT9500HP	-	-		43
981010	Use Kit	FLT9500HP	-	-		-
981011	FLT91009	FLT9500HP	-	-		43
981012	FLT91016	FLT9500HP	-	-		43
981013	FLT91026	FLT9500HP	-	-		44
981014	Use Kit	FLT9500HP	-	-		-
981015	Use Kit	FLT9500HP	-	-		-
981016	FLT91017	FLT9505SP	-	-		19
981017	FLT91104	FLT9500HP	-	-		48
981018	Use Kit	FLT9505SP	-	-		-
981019	FLT91116	FLT9500HP	-	-		23
981020	Use Kit	FLT9505SP	-	-		-
981021	Use Kit	FLT9500HP	-	-		-
981022	FLT91034	FLT9500HP	-	-		44
981023	FLT91018	FLT9500HP	-	-		43
981024	FLT91010	FLT9500HP	-	-		43
981025	Use Kit	FLT9505SP	-	-		-
981026	Use Kit	FLT9500HP	-	-		-
981027	Use Kit	FLT9500HP	-	-		-
981028	FLT91019	FLT9500HP	-	-		44

Mfr. Part #	FLT On/Off	On/Off Kit	FLT 2-Speed	2-Speed Kit	Also Use	Pg. #
981029	Use Kit	FLT9500HP	-	-		-
981030	FLT91034	FLT9500HP	-	-		44
981031	FLT91020	FLT9500HP	-	-		19
981032	Use Kit	FLT9500HP	-	-		-
981033	FLT91109	FLT9500HP	-	-		48
981034	FLT91034	FLT9500HP	-	-		44
981035	FLT91095	FLT9500HP	-	-		47
981036	FLT91012	FLT9505SP	-	-		18
981037	FLT91011	FLT9500HP	-	-		68
981038	FLT91082	FLT9500HP	-	-		21
981039	FLT91029	FLT9500HP	-	-		44
981040	FLT91030	FLT9500HP	-	-		44
981041	FLT91022	FLT9500HP	-	-		44
981042	FLT91021	FLT9500HP	-	-		44
981043	Use Kit	FLT9500HP	-	-		-
981044	Use Kit	FLT9500HP	-	-		-
981045	Use Kit	FLT9500HP	-	-		-
981046	Use Kit	FLT9500HP	-	-		-
981047	FLT91031	FLT9500HP	-	-		68
981048	FLT91023	FLT9500HP	-	-		68
981049	FLT91036	FLT9500HP	-	-		45
981050	FLT91024	FLT9500HP	-	-		68
981051	FLT91067	FLT9500HP	-	-		20
981052	Use Kit	FLT9500HP	-	-		-
981053	FLT91027	FLT9500HP	-	-		19
981054	FLT91027	FLT9500HP	-	-		19
981055	Use Kit	FLT9500HP	-	-		-
981057	FLT91033	FLT9500HP	-	-		68
981058	Use Kit	FLT9500HP	-	-		-
981059	FLT91031	FLT9500HP	-	-		68
981060	FLT91090	FLT9500HP	-	-		22
981061	FLT91024	FLT9500HP	-	-		68
981062	FLT91037	FLT9500HP	-	-		68
981063	FLT91081	FLT9500HP	-	-		21
981064	FLT91014	FLT9500HP	-	-		18
981065	Use Kit	FLT9500HP	-	-		-
981066	Use Kit	FLT9500HP	-	-		-
981067	FLT91116	FLT9500HP	-	-		23
981068	Use Kit	FLT9500HP	-	-		-
981069	FLT91025	FLT9500HP	-	-		19
981070	FLT91011	FLT9500HP	-	-		68
981071	FLT91025	FLT9500HP	-	-		19
981072	Use Kit	FLT9500HP	-	-		-
981073	FLT91009	FLT9500HP	-	-		43
981074	FLT91032	FLT9500HP	-	-		44
981075	FLT91040	FLT9500HP	-	-		82
981076	Use Kit	FLT9500HP	-	-		-
981077	FLT91026	FLT9500HP	-	-		44
981078	Use Kit	FLT9500HP	-	-		-
981080	FLT91028	FLT9500HP	-	-		19
981081	Use Kit	FLT9500HP	-	-		-
981082	FLT91039	FLT9500HP	-	-		82
981083	FLT91040	FLT9500HP	-	-		82
981084	FLT91114	FLT9500HP	-	-		70
981085	FLT91016	FLT9500HP	-	-		43
981086	FLT91041	FLT9500HP	-	-		82
981087	Use Kit	FLT9500HP	-	-		-
981088	FLT91077	FLT9500HP	-	-		69
981089	FLT91094	FLT9500HP	-	-		47
981090	FLT91039	FLT9500HP	-	-		82
981091	FLT91040	FLT9500HP	-	-		82
981092	FLT91041	FLT9500HP	-	-		82
981094	FLT91076	FLT9500HP	-	-		21
981095	Use Kit	FLT9500HP	-	-		-
981096	FLT91006	FLT9500HP	-	-		43
981097	FLT91054	FLT9500HP	-	-		45
981098	FLT91052	FLT9500HP	-	-		69
981099	FLT91038	FLT9500HP	-	-		19
981100	Use Kit	FLT9500HP	-	-		-
981101	FLT91011	FLT9500HP	-	-		68
981102	FLT91000	FLT9500HP	-	-		43
981103	FLT91020	FLT9500HP	-	-		19
981104	FLT91024	FLT9500HP	-	-		68
981105	FLT91082	FLT9500HP	-	-		21
981106	FLT91102	FLT9500HP	-	-		22

Mfr. Part #	Fleetrite On/Off	On/Off Kit	FLT 2-Speed	2-Speed Kit	Also Use	Pg. #
981107	Use Kit	FLT9500HP	-	-		-
981108	FLT91110	FLT9500HP	-	-		48
981109	FLT91026	FLT9500HP	-	-		44
981110	FLT91014	FLT9500HP	-	-		18
981111	FLT91030	FLT9500HP	-	-		44
981112	FLT91023	FLT9500HP	-	-		68
981113	FLT91009	FLT9500HP	-	-		43
981114	FLT91035	FLT9500HP	-	-		19
981115	FLT91043	FLT9500HP	-	-		78
981116	FLT91000	FLT9500HP	-	-		43
981117	FLT91028	FLT9500HP	-	-		19
981118	FLT91089	FLT9500HP	-	-		22
981119	FLT91067	FLT9500HP	-	-		20
981120	FLT91024	FLT9500HP	-	-		68
981121	FLT91001	FLT9500HP	-	-		43
981122	FLT91042	FLT9500HP	-	-		78
981123	FLT91052	FLT9500HP	-	-		69
981124	FLT91087	FLT9500HP	-	-		22
981125	FLT91090	FLT9500HP	-	-		22
981126	FLT91027	FLT9500HP	-	-		19
981127	FLT91011	FLT9500HP	-	-		68
981128	FLT91000	FLT9500HP	-	-		43
981129	FLT91001	FLT9500HP	-	-		43
981130	FLT91106	FLT9500HP	-	-		22
981131	Use Kit	FLT9500HP	-	-		-
981132	FLT91028	FLT9500HP	-	-		19
981133	FLT91032	FLT9500HP	-	-		44
981134	Use Kit	FLT9500HP	-	-		-
981135	Use Kit	FLT9500HP	-	-		-
981136	FLT91035	FLT9500HP	-	-		19
981138	FLT91021	FLT9500HP	-	-		44
981139	FLT91022	FLT9500HP	-	-		44
981140	FLT91012	FLT9505SP	-	-		18
981141	FLT91007	FLT9500HP	-	-		18
981143	FLT91024	FLT9500HP	-	-		68
981144	FLT91071	FLT9500HP	-	-		21
981145	FLT91009	FLT9500HP	-	-		43
981146	FLT91024	FLT9500HP	-	-		68
981147	FLT91024	FLT9500HP	-	-		68
981148	FLT91014	FLT9500HP	-	-		18
981149	FLT91035	FLT9500HP	-	-		19
981150	FLT91025	FLT9500HP	-	-		19
981151	FLT91006	FLT9500HP	-	-		43
981152	FLT91018	FLT9500HP	-	-		43
981153	FLT91015	FLT9500HP	-	-		18
981154	FLT91010	FLT9500HP	-	-		43
981155	FLT91019	FLT9500HP	-	-		44
981156	FLT91029	FLT9500HP	-	-		44
981157	FLT91034	FLT9500HP	-	-		44
981158	FLT91022	FLT9500HP	-	-		44
981159	FLT91023	FLT9500HP	-	-		68
981160	FLT91076	FLT9500HP	-	-		21
981161	FLT91052	FLT9500HP	-	-		69
981162	FLT91054	FLT9500HP	-	-		45
981163	FLT91089	FLT9500HP	-	-		22
981164	FLT91032	FLT9500HP	-	-		44
981165	FLT91102	FLT9500HP	-	-		22
981166	Use Kit	FLT9500HP	-	-		-
981167	FLT91036	FLT9500HP	-	-		45
981168	FLT91043	FLT9500HP	-	-		78
981169	FLT91016	FLT9500HP	-	-		43
981170	FLT91036	FLT9500HP	-	-		45
981171	FLT91106	FLT9500HP	-	-		22
981172	FLT91012	FLT9505SP	-	-		18
981173	Use Kit	FLT9500HP	-	-		-
981174	Use Kit	FLT9500HP	-	-		-
981175	Use Kit	FLT9500HP	-	-		-
981176	FLT91024	FLT9500HP	-	-		68
981177	FLT91094	FLT9500HP	-	-		47
981178	Use Kit	FLT9500HP	-	-		-
981179	FLT91039	FLT9500HP	-	-		82
981180	FLT91040	FLT9500HP	-	-		82
981181	FLT91041	FLT9500HP	-	-		82
981182	FLT91071	FLT9500HP	-	-		21
981183	FLT91037	FLT9500HP	-	-		68

Mfr. Part #	FLT On/Off	On/Off Kit	FLT 2-Speed	2-Speed Kit	Also Use	Pg. #
981184	FLT91068	FLT9500HP	-	-		21
981185	FLT91115	FLT9505SP	-	-		22
981186	FLT91016	FLT9500HP	-	-		43
981187	FLT91110	FLT9500HP	-	-		48
981188	FLT91077	FLT9500HP	-	-		69
981189	FLT91057	FLT9500HP	-	-		20
981190	FLT91058	FLT9500HP	-	-		45
981191	Use Kit	FLT9500HP	-	-		-
981192	Use Kit	FLT9500HP	-	-		-
981193	Use Kit	FLT9500HP	-	-		-
981194	FLT91059	FLT9500HP	-	-		20
981195	Use Kit	FLT9500HP	-	-		-
981196	Use Kit	FLT9500HP	-	-		-
981197	FLT91072	FLT9500HP	-	-		46
981198	FLT91000	FLT9500HP	-	-		43
981199	FLT91060	FLT9500HP	-	-		20
981200	Use Kit	FLT9500HP	-	-		-
981201	Use Kit	FLT9500HP	-	-		-
981202	Use Kit	FLT9500HP	-	-		-
981203	FLT91061	FLT9500HP	-	-		45
981204	Use Kit	FLT9500HP	-	-		-
981205	Use Kit	FLT9500HP	-	-		-
981206	FLT91114	FLT9500HP	-	-		70
981207	FLT91033	FLT9500HP	-	-		68
981208	FLT91085	FLT9500HP	-	-		21
981209	FLT91011	FLT9500HP	-	-		68
981210	Use Kit	FLT9500HP	-	-		-
981211	Use Kit	FLT9500HP	-	-		-
981212	FLT91100	FLT9500HP	-	-		48
981213	Use Kit	FLT9500HP	-	-		-
981214	FLT91007	FLT9500HP	-	-		18
981215	Use Kit	FLT9500HP	-	-		-
981216	FLT91012	FLT9500HP	-	-		18
981217	Use Kit	FLT9500HP	-	-		-
981218	Use Kit	FLT9500HP	-	-		-
981219	FLT91007	FLT9500HP	-	-		18
981220	Use Kit	FLT9500HP	-	-		-
981221	FLT91087	FLT9500HP	-	-		22
981222	Use Kit	FLT9500HP	-	-		-
981223	Use Kit	FLT9500HP	-	-		-
981224	FLT91024	FLT9500HP	-	-		68
981225	FLT91054	FLT9500HP	-	-		45
981226	FLT91035	FLT9500HP	-	-		19
981227	FLT91031	FLT9500HP	-	-		68
981228	FLT91031	FLT9500HP	-	-		68
981229	FLT91023	FLT9500HP	-	-		68
981230	FLT91011	FLT9500HP	-	-		68
981231	Use Kit	FLT9500HP	-	-		-
981232	FLT91052	FLT9500HP	-	-		69
981233	FLT91029	FLT9500HP	-	-		44
981234	FLT91032	FLT9500HP	-	-		44
981235	FLT91030	FLT9500HP	-	-		44
981236	Use Kit	FLT9500HP	-	-		-
981237	Use Kit	FLT9500HP	-	-		-
981238	FLT91038	FLT9500HP	-	-		19
981239	FLT91019	FLT9500HP	-	-		44
981240	Use Kit	FLT9500HP	-	-		-
981241	Use Kit	FLT9500HP	-	-		-
981242	FLT91036	FLT9500HP	-	-		45
981243	FLT91009	FLT9500HP	-	-		43
981244	FLT91068	FLT9500HP	-	-		21
981245	Use Kit	FLT9500HP	-	-		-
981246	Use Kit	FLT9500HP	-	-		-
981247	Use Kit	FLT9500HP	-	-		-
981248	Use Kit	FLT9500HP	-	-		-
981249	Use Kit	FLT9500HP	-	-		-
981250	FLT91071	FLT9500HP	-	-		21
981251	FLT91026	FLT9500HP	-	-		44
981252	FLT91000	FLT9500HP	-	-		43
981253	FLT91026	FLT9500HP	-	-		44
981254	FLT91095	FLT9500HP	-	-		47
981255	Use Kit	FLT9500HP	-	-		-
981256	FLT91082	FLT9500HP	-	-		21
981257	FLT91028	FLT9500HP	-	-		19
981258	Use Kit	FLT9500HP	-	-		-

Cross Reference Horton-style compatible

Mfr. Part #	Fleetrite On/Off	On/Off Kit	FLT 2-Speed	2-Speed Kit	Also Use	Pg. #
981260	FLT91000	FLT9500HP	-	-		43
981261	FLT91007	FLT9500HP	-	-		18
981262	FLT91001	FLT9500HP	-	-		43
981264	FLT91081	FLT9500HP	-	-		21
981265	FLT91005	FLT9500HP	-	-		18
981266	FLT91116	FLT9500HP	-	-		23
981267	Use Kit	FLT9500HP	-	-		-
981268	Use Kit	FLT9500HP	-	-		-
981269	Use Kit	FLT9500HP	-	-		-
981270	Use Kit	FLT9500HP	-	-		-
981271	FLT91055	FLT9500HP	-	-		45
981272	FLT91032	FLT9500HP	-	-		44
981273	FLT91016	FLT9500HP	-	-		43
981274	Use Kit	FLT9500HP	-	-		-
981275	Use Kit	FLT9500HP	-	-		-
981276	FLT91056	FLT9500HP	-	-		45
981277	FLT91068	FLT9500HP	-	-		21
981278	Use Kit	FLT9500HP	-	-		-
981279	FLT91001	FLT9500HP	-	-		43
981280	FLT91109	FLT9500HP	-	-		48
981281	FLT91017	FLT9505SP	-	-		19
981282	FLT91008	FLT9505SP	-	-		18
981283	FLT91112	FLT9500HP	-	-		49
981284	FLT91003	FLT9505SP	-	-		18
981285	Use Kit	FLT9505SP	-	-		-
981286	Use Kit	FLT9500HP	-	-		-
981287	Use Kit	FLT9500HP	-	-		-
981288	FLT91004	FLT9500HP	-	-		43
981289	FLT91104	FLT9500HP	-	-		48
981290	FLT91103	FLT9500HP	-	-		48
981291	FLT91108	FLT9500HP	-	-		48
981292	Use Kit	FLT9500HP	-	-		-
981294	FLT91007	FLT9500HP	-	-		18
981295	FLT91081	FLT9500HP	-	-		21
981296	Use Kit	FLT9500HP	-	-		-
981297	FLT91107	FLT9500HP	-	-		70
981298	FLT91011	FLT9500HP	-	-		68
981299	FLT91087	FLT9500HP	-	-		22
981300	FLT91088	FLT9500HP	-	-		47
981301	FLT91101	FLT9500HP	-	-		48
981302	Use Kit	FLT9500HP	-	-		-
981303	FLT91102	FLT9500HP	-	-		22
981304	FLT91095	FLT9500HP	-	-		47
981305	FLT91094	FLT9500HP	-	-		47
981306	Use Kit	FLT9500HP	-	-		-
981307	Use Kit	FLT9500HP	-	-		-
981308	Use Kit	FLT9500HP	-	-		-
981309	FLT91020	FLT9500HP	-	-		19
981310	FLT91071	FLT9500HP	-	-		21
981311	FLT91099	FLT9500HP	-	-		47
981312	FLT91062	FLT9506HP	-	-		69
981313	Use Kit	FLT9500HP	-	-		-
981314	Use Kit	FLT9500HP	-	-		-
981315	Use Kit	FLT9500HP	-	-		-
981316	FLT91037	FLT9500HP	-	-		68
981317	FLT91031	FLT9500HP	-	-		68
981318	FLT91066	FLT9500HP	-	-		20
981319	FLT91066	FLT9500HP	-	-		20
981320	Use Kit	FLT9500HP	-	-		-
981321	FLT91028	FLT9500HP	-	-		19
981322	FLT91072	FLT9500HP	-	-		46
981323	FLT91107	FLT9500HP	-	-		70
981324	FLT91024	FLT9500HP	-	-		68
981325	FLT91036	FLT9500HP	-	-		45
981326	Use Kit	FLT9500HP	-	-		-
981327	FLT91035	FLT9500HP	-	-		19
981328	FLT91009	FLT9500HP	-	-		43
981329	Use Kit	FLT9500HP	-	-		-
981330	Use Kit	FLT9500HP	-	-		-
981331	Use Kit	FLT9500HP	-	-		-
981332	Use Kit	FLT9500HP	-	-		-
981333	Use Kit	FLT9500HP	-	-		-
981334	FLT91062	FLT9506HP	-	-		69
981335	Use Kit	FLT9500HP	-	-		-
981336	FLT91083	FLT9500HP	-	-		69

Mfr. Part #	FLT On/Off	On/Off Kit	FLT 2-Speed	2-Speed Kit	Also Use	Pg. #
981337	Use Kit	FLT9500HP	-	-		-
981338	FLT91098	FLT9500HP	-	-		22
981339	FLT91066	FLT9500HP	-	-		20
981340	FLT91072	FLT9500HP	-	-		46
981341	FLT91063	FLT9500HP	-	-		20
981342	FLT91024	FLT9500HP	-	-		68
981343	FLT91097	FLT9500HP	-	-		22
981344	FLT91096	FLT9500HP	-	-		47
981345	FLT91113	FLT9500HP	-	-		49
981346	Use Kit	FLT9500HP	-	-		-
981347	Use Kit	FLT9500HP	-	-		-
981348	FLT91074	FLT9500HP	-	-		46
981349	FLT91014	FLT9500HP	-	-		18
981350	Use Kit	FLT9500HP	-	-		-
981351	FLT91064	FLT9500HP	-	-		46
981352	Use Kit	FLT9500HP	-	-		-
981354	FLT91001	FLT9500HP	-	-		43
981355	FLT91001	FLT9500HP	-	-		43
981356	Use Kit	FLT9500HP	-	-		-
981357	FLT91006	FLT9500HP	-	-		43
981358	FLT91006	FLT9500HP	-	-		43
981359	FLT91004	FLT9500HP	-	-		43
981360	FLT91081	FLT9500HP	-	-		21
981361	Use Kit	FLT9500HP	-	-		-
981362	FLT91014	FLT9500HP	-	-		18
981363	FLT91014	FLT9500HP	-	-		18
981364	FLT91081	FLT9500HP	-	-		21
981365	FLT91070	FLT9500HP	-	-		21
981366	FLT91070	FLT9500HP	-	-		21
981367	Use Kit	FLT9500HP	-	-		-
981368	FLT91091	FLT9500HP	-	-		69
981369	FLT91000	FLT9500HP	-	-		43
981370	Use Kit	FLT9500HP	-	-		-
981371	Use Kit	FLT9500HP	-	-		-
981372	Use Kit	FLT9500HP	-	-		-
981373	Use Kit	FLT9500HP	-	-		-
981374	Use Kit	FLT9500HP	-	-		-
981375	Use Kit	FLT9500HP	-	-		-
981376	Use Kit	FLT9500HP	-	-		-
981377	FLT91001	FLT9500HP	-	-		43
981378	Use Kit	FLT9500HP	-	-		-
981379	FLT91055	FLT9500HP	-	-		45
981381	FLT91029	FLT9500HP	-	-		44
981382	FLT91023	FLT9500HP	-	-		68
981383	FLT91076	FLT9500HP	-	-		21
981384	FLT91052	FLT9500HP	-	-		69
981385	FLT91032	FLT9500HP	-	-		44
981386	FLT91038	FLT9500HP	-	-		19
981389	FLT91086	FLT9500HP	-	-		47
981390	Use Kit	FLT9500HP	-	-		-
981391	FLT91092	FLT9500HP	-	-		47
981392	Use Kit	FLT9500HP	-	-		-
981393	FLT91111	FLT9500HP	-	-		48
981394	FLT91093	FLT9504HP	-	-		47
981395	FLT91105	FLT9500HP	-	-		69
981397	Use Kit	FLT9500HP	-	-		-
981398	Use Kit	FLT9500HP	-	-		-
981399	Use Kit	FLT9500HP	-	-		-
981400	Use Kit	FLT9500HP	-	-		-
981401	FLT91112	FLT9500HP	-	-		49
984154		FLT24256	-	-	FLT244700	-
984160		FLT24256	-	-	FLT244700	-
984178		FLT24256	-	-	FLT244700	-
984221		FLT24256	-	-	FLT244700	-
987000	Use Kit	FLT9500HP	-	-		-
987001	Use Kit	FLT9500HP	-	-		-
987002	Use Kit	FLT9500HP	-	-		-
987003	Use Kit	FLT9500HP	-	-		-
987004	Use Kit	FLT9500HP	-	-		-
987005	Use Kit	FLT9500HP	-	-		-
987006	Use Kit	FLT9500HP	-	-		-
987007	Use Kit	FLT9500HP	-	-		-
987008	FLT91079	FLT9500HP	-	-		46
987009	FLT91075	FLT9500HP	-	-		46
987010	FLT91042	FLT9500HP	-	-		78

Mfr. Part #	Fleetrite On/Off	On/Off Kit	FLT 2-Speed	2-Speed Kit	Also Use	Pg. #
987011	FLT91043	FLT9500HP	-	-	-	78
987016	Use Kit	FLT9500HP	-	-	-	-
987017	FLT91078	FLT9500HP	-	-	-	46
987018	FLT91073	FLT9500HP	-	-	-	46
987019	Use Kit	FLT9500HP	-	-	-	-
987024	Use Kit	FLT9500HP	-	-	-	-
987025	FLT91084	FLT9500HP	-	-	-	86
987026	Use Kit	FLT9500HP	-	-	-	-
987027	Use Kit	FLT9500HP	-	-	-	-
987028	Use Kit	FLT9500HP	-	-	-	-
987029	FLT91037	FLT9500HP	-	-	-	68
987030	Use Kit	FLT9500HP	-	-	-	-
987032	FLT91084	FLT9500HP	-	-	-	86
987033	Use Kit	FLT9500HP	-	-	-	-
987034	Use Kit	FLT9500HP	-	-	-	-
987035	FLT91073	FLT9500HP	-	-	-	46
987036	Use Kit	FLT9500HP	-	-	-	-
987037	FLT91044	FLT9500HP	-	-	-	45
987038	FLT91045	FLT9500HP	-	-	-	45
987039	Use Kit	FLT9500HP	-	-	-	-
987040	Use Kit	FLT9500HP	-	-	-	-
987041	Use Kit	FLT9500HP	-	-	-	-
987042	Use Kit	FLT9500HP	-	-	-	-
987043	FLT91080	FLT9500HP	-	-	-	46
987044	Use Kit	FLT9500HP	-	-	-	-
987045	Use Kit	FLT9500HP	-	-	-	-
987046	Use Kit	FLT9500HP	-	-	-	-
987047	Use Kit	FLT9500HP	-	-	-	-
987048	Use Kit	FLT9500HP	-	-	-	-
987049	Use Kit	FLT9500HP	-	-	-	-
987050	Use Kit	FLT9500HP	-	-	-	-
987051	Use Kit	FLT9500HP	-	-	-	-
987052	Use Kit	FLT9500HP	-	-	-	-
987053	Use Kit	FLT9500HP	-	-	-	-
987054	FLT91046	FLT9500HP	-	-	-	68
987055	FLT91047	FLT9500HP	-	-	-	68
987056	Use Kit	FLT9500HP	-	-	-	-
987057	Use Kit	FLT9500HP	-	-	-	-
987058	FLT91048	FLT9500HP	-	-	-	19
987059	FLT91049	FLT9500HP	-	-	-	20
987060	Use Kit	FLT9500HP	-	-	-	-
987061	Use Kit	FLT9500HP	-	-	-	-
987062	FLT91050	FLT9500HP	-	-	-	69
987063	Use Kit	FLT9500HP	-	-	-	-
987064	FLT91075	FLT9500HP	-	-	-	46
987065	FLT91079	FLT9500HP	-	-	-	46
987066	Use Kit	FLT9500HP	-	-	-	-
987067	FLT91051	FLT9500HP	-	-	-	20
987068	FLT91116	FLT9500HP	-	-	-	23
987069	Use Kit	FLT9500HP	-	-	-	-
987070	Use Kit	FLT9500HP	-	-	-	-
987073	FLT91091	FLT9500HP	-	-	-	69
987074	Use Kit	FLT9500HP	-	-	-	-
987075	Use Kit	FLT9500HP	-	-	-	-
987076	FLT91097	FLT9500HP	-	-	-	22
987077	FLT91066	FLT9500HP	-	-	-	20
987078	FLT91070	FLT9500HP	-	-	-	21
987079	FLT91070	FLT9500HP	-	-	-	21
987080	Use Kit	FLT9500HP	-	-	-	-
987081	FLT91080	FLT9500HP	-	-	-	46
987082	Use Kit	FLT9500HP	-	-	-	-
987084	Use Kit	FLT9500HP	-	-	-	-
987085	FLT91088	FLT9500HP	-	-	-	47
987086	Use Kit	FLT9500HP	-	-	-	-
988001	FLT228005	-	-	-	-	-
988002	FLT228006	-	-	-	-	-
988003	FLT228006	-	-	-	-	-
988004	FLT228006	-	-	-	-	-
988005	FLT228005	-	-	-	-	-
988006	FLT228006	-	-	-	-	-
988162	-	-	FLT996272	FLT242561	-	-
988600	FLT98600	FLT14256	FLT986002	FLT24256	-	49
988601	FLT98601	FLT14256	FLT986012	FLT24256	-	49
988602	FLT98602	FLT14256	FLT98602	FLT24256	-	-
988603	FLT98603	FLT14256	FLT986032	FLT24256	-	-

Mfr. Part #	FLT On/Off	On/Off Kit	FLT 2-Speed	2-Speed Kit	Also Use	Pg. #
988604	FLT98604	FLT14256	FLT986042	FLT24256	-	-
988605	FLT99410	FLT14256	FLT994102	FLT24256	-	76
988606	-	-	FLT986062	FLT24256	-	-
988607	FLT98607	FLT14256	FLT986072	FLT24256	-	78
988608	FLT98608	FLT14256	FLT986082	FLT24256	-	-
988609	FLT98609	FLT14256	FLT986092	FLT24256	-	-
988610	FLT99160	FLT14256	FLT991602	FLT24256	-	27
988611	FLT98611	FLT14256	FLT986112	FLT24256	-	-
988612	-	-	FLT986122	FLT24256	-	-
988613	FLT98613	FLT14256	FLT986132	FLT24256	-	-
988614	FLT98614	FLT14256	FLT986142	FLT24256	-	23
988615	FLT98615	FLT14256	FLT986152	FLT24256	-	70
988616	FLT98616	FLT14256	FLT986162	FLT24256	-	-
988617	FLT98617	FLT14256	FLT986172	FLT24256	-	-
988618	FLT98618	FLT14256	FLT986182	FLT24256	-	-
988620	FLT98620	FLT14256	FLT986202	FLT24256	-	70
988621	FLT98621	FLT14256	FLT986212	FLT24256	-	70
988622	FLT98622	FLT14256	FLT986222	FLT24256	-	-
988623	FLT98623	FLT14256	FLT986232	FLT24256	-	-
988624	FLT98624	FLT14256	FLT986242	FLT24256	FLT300SK	-
988625	FLT98625	FLT14256	FLT986252	FLT24256	-	-
988627	FLT98627	FLT14256	FLT986272	FLT24256	-	85
988629	FLT98629	FLT14256	FLT986292	FLT24256	-	-
988630	FLT98630	FLT14256	FLT986302	FLT24256	-	83
988631	FLT98631	FLT14256	FLT986312	FLT24256	-	85
988632	FLT98632	FLT14256	FLT986322	FLT24256	-	85
988633	FLT98633	FLT14256	FLT986332	FLT24256	-	-
988639	FLT99352	FLT14256	FLT993522	FLT24256	-	62
988640	FLT99254	FLT14256	FLT992542	FLT24256	-	-
988641	FLT98641	FLT14256	FLT986412	FLT24256	-	23
988644	FLT99514	FLT14256	FLT995142	FLT24256	-	-
988645	FLT98645	FLT14256	FLT986452	FLT24256	-	23
989001	FLT99001	FLT14256	FLT990012	FLT24256	-	70
989002	FLT99002	FLT14200	FLT990022	FLT24-200	Remove Studs	49
989003	FLT99003	FLT14200	FLT990032	FLT24-200	Remove Studs	71
989004	FLT99004	FLT14256	FLT990042	FLT24256	-	49
989005	FLT99005	FLT14256	FLT990052	FLT24256	-	49
989006	FLT99006	FLT14200	FLT990062	FLT24-200	-	71
989007	FLT99007	FLT14256	FLT990072	FLT24256	-	71
989008	FLT99008	FLT14256	FLT990082	FLT24256	-	23
989009	FLT99009	FLT14256	FLT990092	FLT24256	-	23
989010	FLT99010	FLT14256	FLT990102	FLT24256	-	49
989011	FLT99011	FLT14256	FLT990112	FLT24256	-	50
989012	FLT99012	FLT14256	FLT990122	FLT24256	-	23
989013	FLT99013	FLT14256	FLT990132	FLT24256	-	-
989014	FLT99014	FLT14256	FLT990142	FLT24256	-	50
989015	FLT99015	FLT14256	FLT990152	FLT24256	-	50
989016	FLT99016	FLT14256	FLT990162	FLT24256	-	71
989017	FLT99017	FLT14256	FLT990172	FLT24256	-	71
989018	FLT99018	FLT14256	FLT990182	FLT24256	-	71
989019	FLT99019	FLT14256	FLT990192	FLT24256	-	86
989020	FLT99020	FLT14256	FLT990202	FLT24256	-	53
989023	FLT99023	FLT14256	FLT990232	FLT24256	-	78
989024	FLT99024	FLT14256	FLT990242	FLT24256	-	78
989025	FLT99025	FLT14200	FLT990252	FLT24-200	Remove Studs	50
989026	FLT99026	FLT14256	FLT990262	FLT24256	-	50
989027	FLT99027	FLT14256	FLT990272	FLT24256	FLT250SK	71
989028	FLT99028	FLT14256	FLT990282	FLT24256	-	71
989029	FLT99029	FLT14256	FLT990292	FLT24256	-	72
989030	FLT99030	FLT14256	FLT990302	FLT24256	-	50
989031	FLT99031	FLT14256	FLT990312	FLT24256	FLT250SK	72
989034	FLT99034	FLT14256	FLT990342	FLT24256	-	24
989035	FLT99035	FLT14256	FLT990352	FLT24256	-	50
989036	FLT99036	FLT14256	FLT990362	FLT24256	-	50
989037	FLT99037	FLT14256	FLT990372	FLT24256	-	24
989038	FLT99038	FLT14256	FLT990382	FLT24256	-	24
989039	FLT99039	FLT14256	FLT990392	FLT24256	-	-
989040	FLT99040	FLT14256	FLT990402	FLT24256	-	-
989041	FLT99041	FLT14256	FLT990412	FLT24256	-	72
989043	FLT99043	FLT14256	FLT990432	FLT24256	-	-
989044	FLT99044	FLT14256	FLT990442	FLT24256	-	24
989045	FLT99045	FLT14256	FLT990452	FLT24256	-	51
989046	FLT99046	FLT14256	FLT990462	FLT24256	-	24
989047	FLT99047	FLT14256	FLT990472	FLT24256	-	53
989048	FLT99048	FLT14256	FLT990482	FLT24256	-	51

Cross Reference Horton-style compatible

Mfr. Part #	Fleetrite On/Off	On/Off Kit	FLT 2-Speed	2-Speed Kit	Also Use	Pg. #
989049	FLT99049	FLT14256	FLT990492	FLT24256		72
989050	FLT99050	FLT14256	FLT990502	FLT24256		51
989051	FLT99051	FLT14256	FLT990512	FLT24256		51
989052	FLT99052	FLT14256	FLT990522	FLT24256		51
989053	FLT99053	FLT14256	FLT990532	FLT24256		51
989054	FLT99054	FLT14256	FLT990542	FLT24256		51
989055	FLT99055	FLT14256	FLT990552	FLT24256		51
989056	FLT99056	FLT14256	FLT990562	FLT24256		52
989057	FLT99057	FLT14256	FLT990572	FLT24256		52
989058	FLT99058	FLT14256	FLT990582	FLT24256		52
989059	FLT99059	FLT14256	FLT990592	FLT24256		52
989060	FLT99060	FLT14256	FLT990602	FLT24256		52
989061	FLT99061	FLT14256	FLT990612	FLT24256		72
989062	FLT99062	FLT14256	FLT990622	FLT24256		72
989063	FLT99063	FLT14256	FLT990632	FLT24256		72
989064	FLT99064	FLT14256	FLT990642	FLT24256		72
989065	FLT99065	FLT14256	FLT990652	FLT24256		73
989066	FLT99066	FLT14256	FLT990662	FLT24256		73
989067	FLT99067	FLT14256	FLT990672	FLT24256		-
989068	FLT99068	FLT14256	FLT990682	FLT24256		24
989069	FLT99069	FLT14256	FLT990692	FLT24256		24
989070	FLT99070	FLT14256	FLT990702	FLT24256		24
989071	FLT99071	FLT14256	FLT990712	FLT24256		30
989072	FLT99072	FLT14256	FLT990722	FLT24256		25
989073	FLT99073	FLT14256	FLT990732	FLT24256		25
989074	FLT99074	FLT14256	FLT990742	FLT24256		25
989075	FLT99075	FLT14256	FLT990752	FLT24256		25
989076	FLT99076	FLT14256	FLT990762	FLT24256		25
989077	FLT99077	FLT142561	FLT990772	FLT242561		83
989078	FLT99078	FLT14256	FLT990782	FLT24256		25
989079	FLT99079	FLT14256	FLT990792	FLT24256		25
989080	FLT99080	FLT14256	FLT990802	FLT24256		25
989081	FLT99081	FLT14256	FLT990812	FLT24256		52
989082	FLT99082	FLT14256	FLT990822	FLT24256		52
989083	FLT99083	FLT14256	FLT990832	FLT24256		-
989084	FLT99084	FLT14256	FLT990842	FLT24256		26
989085	FLT99085	FLT14256	FLT990852	FLT24256		73
989087	FLT99087	FLT14256	FLT990872	FLT24256		-
989088	FLT99088	FLT14256	FLT990882	FLT24256		52
989090	FLT99090	FLT14256	FLT990902	FLT24256		53
989091	FLT99091	FLT14256	FLT990912	FLT24256		-
989092	FLT99092	FLT14256	FLT990922	FLT24256		73
989093	FLT99093	FLT14256	FLT990932	FLT24256		73
989094	FLT99094	FLT14256	FLT990942	FLT24256		53
989095	FLT99095	FLT14256	FLT990952	FLT24256		53
989096	FLT99096	FLT14256	FLT990962	FLT24256		52
989097	FLT99097	FLT14256	FLT990972	FLT24256		53
989098	FLT99098	FLT14256	FLT990982	FLT24256		26
989099	FLT99099	FLT14256	FLT990992	FLT24256		53
989100	FLT99100	FLT14256	FLT991002	FLT24256		-
989101	FLT99101	FLT14256	FLT991012	FLT24256		53
989102	FLT99102	FLT14256	FLT991022	FLT24256		-
989103	FLT99103	FLT14256	FLT991032	FLT24256		26
989104	FLT99104	FLT14256	FLT991042	FLT24256		53
989106	FLT99106	FLT14256	FLT991062	FLT24256		-
989107	FLT99107	FLT14256	FLT991072	FLT24256		-
989108	FLT99108	FLT14256	FLT991082	FLT24256		53
989110	FLT99110	FLT14256	FLT991102	FLT24256	FLT350SK	54
989111	FLT99111	FLT14256	FLT991112	FLT24256		54
989112	FLT99112	FLT14256	FLT991122	FLT24256		54
989113	FLT99113	FLT14256	FLT991132	FLT24256		54
989114	FLT99114	FLT14256	FLT991142	FLT24256		54
989115	FLT99115	FLT14256	FLT991152	FLT24256		54
989116	FLT99116	FLT14256	FLT991162	FLT24256	FLT250SK	54
989117	FLT99117	FLT14256	FLT991172	FLT24256		54
989118	FLT99118	FLT14256	FLT991182	FLT24256		55
989119	FLT99119	FLT14256	FLT991192	FLT24256		26
989124	FLT99124	FLT14256	FLT991242	FLT24256		55
989125	FLT99125	FLT142561	FLT991252	FLT242561		55
989126	FLT99126	FLT14256	FLT991262	FLT24256		55
989127	FLT99127	FLT14256	FLT991272	FLT24256		55
989128	FLT99128	FLT14256	FLT991282	FLT24256		55
989129	FLT99129	FLT14256	FLT991292	FLT24256		55
989130	FLT99130	FLT14256	FLT991302	FLT24256		55
989131	FLT99131	FLT14256	FLT991312	FLT24256		56

Mfr. Part #	FLT On/Off	On/Off Kit	FLT 2-Speed	2-Speed Kit	Also Use	Pg. #
989132	FLT99132	FLT14256	FLT991322	FLT24256		56
989133	FLT99133	FLT14256	FLT991332	FLT24256		56
989134	FLT99134	FLT14256	FLT991342	FLT24256		56
989135	FLT99135	FLT14256	FLT991352	FLT24256		26
989136	FLT99136	FLT14256	FLT991362	FLT24256		-
989139	FLT99139	FLT14256	FLT991392	FLT24256		26
989142	FLT99142	FLT142561	FLT991422	FLT242561		83
989143	FLT99143	FLT142561	FLT991432	FLT242561		83
989146	FLT99146	FLT14256	FLT991462	FLT24256		73
989147	FLT99147	FLT14256	FLT991472	FLT24256	FLT425SK	-
989149	FLT99149	FLT14256	FLT991492	FLT24256	FLT200SK	-
989150	FLT99150	FLT14256	FLT991502	FLT24256		56
989151	FLT99151	FLT14256	FLT991512	FLT24256	FLT200SK	73
989152	FLT99152	FLT14256	FLT991522	FLT24256		-
989153	FLT99153	FLT14200	FLT991532	FLT24-200		56
989154	FLT99154	FLT14256	FLT991542	FLT24256		56
989155	FLT99155	FLT14256	FLT991552	FLT24256		26
989157	FLT99157	FLT14256	FLT991572	FLT24256		26
989158	FLT99158	FLT14200	FLT991582	FLT24-200		-
989159	FLT99159	FLT14256	FLT991592	FLT24256		-
989160	FLT99160	FLT14256	FLT991602	FLT24256		27
989161	FLT99161	FLT14256	FLT991612	FLT24256		27
989162	FLT99162	FLT14256	FLT991622	FLT24256		27
989163	FLT99163	FLT14256	FLT991632	FLT24256		27
989164	FLT99164	FLT14256	FLT991642	FLT24256		27
989165	FLT99165	FLT14256	FLT991652	FLT24256		-
989166	FLT99166	FLT14256	FLT991662	FLT24256		-
989167	FLT99167	FLT14256	FLT991672	FLT24256		56
989168	FLT99168	FLT14256	FLT991682	FLT24256		57
989169	FLT99169	FLT14256	FLT991692	FLT24256		57
989170	FLT99170	FLT14256	FLT991702	FLT24256	FLT250SK	57
989171	FLT99171	FLT14256	FLT991712	FLT24256		57
989172	FLT99172	FLT14256	FLT991722	FLT24256	FLT200SK	57
989173	FLT99173	FLT14256	FLT991732	FLT24256		27
989174	FLT99174	FLT14256	FLT991742	FLT24256		57
989175	FLT99175	FLT14256	FLT991752	FLT24256		57
989176	FLT99176	FLT14256	FLT991762	FLT24256	FLT250SK	-
989177	FLT99177	FLT14256	FLT991772	FLT24256		27
989181	FLT99181	FLT14200	FLT991812	FLT24-200	FLT300SK	-
989183	FLT99183	FLT14256	FLT991832	FLT24256		35
989184	FLT99184	FLT14256	FLT991842	FLT24256		36
989186	FLT99186	FLT14256	FLT991862	FLT24256	FLT244700	-
989187	FLT99187	FLT14256	FLT991872	FLT24256		-
989188	FLT99188	FLT14256	FLT991882	FLT24256		57
989189	FLT99189	FLT14256	FLT991892	FLT24256		27
989190	FLT99190	FLT14256	FLT991902	FLT24256		28
989191	FLT99191	FLT14256	FLT991912	FLT24256	FLT300SK	28
989192	FLT99192	FLT14256	FLT991922	FLT24256		27
989194	FLT99194	FLT14256	FLT991942	FLT24256		28
989195	FLT99195	FLT14256	FLT991952	FLT24256		63
989196	FLT99196	FLT14256	FLT991962	FLT24256		86
989197	FLT99197	FLT14256	FLT991972	FLT24256		86
989198	FLT99198	FLT14256	FLT991982	FLT24256		58
989199	FLT99199	FLT14256	FLT991992	FLT24256		28
989200	FLT99200	FLT14256	FLT992002	FLT24256		28
989201	FLT99201	FLT14200	FLT992012	FLT24-200	FLT200SK	58
989202	FLT99202	FLT14256	FLT992022	FLT24256		-
989203	FLT99203	FLT14256	FLT992032	FLT24256		74
989204	FLT99204	FLT14256	FLT992042	FLT24256		74
989205	FLT99205	FLT14256	FLT992052	FLT24256		58
989206	FLT99206	FLT14256	FLT992062	FLT24256		-
989207	FLT99207	FLT14256	FLT992072	FLT24256		58
989208	FLT99208	FLT14256	FLT992082	FLT24256		28
989209	FLT99209	FLT14256	FLT992092	FLT24256		28
989211	FLT99211	FLT14256	FLT992112	FLT24256		28
989212	FLT99212	FLT14256	FLT992122	FLT24256		29
989213	FLT99213	FLT14256	FLT992132	FLT24256		-
989214	FLT99214	FLT14256	FLT992142	FLT24256		-
989216	FLT99216	FLT14256	FLT992162	FLT24256	FLT250SK	74
989217	FLT99217	FLT14256	FLT992172	FLT24256		74
989218	FLT99218	FLT14256	FLT992182	FLT24256	FLT250SK	58
989219	FLT99219	FLT14256	FLT992192	FLT24256	FLT250SK	58
989220	FLT99220	FLT14256	FLT992202	FLT24256		29
989221	FLT99221	FLT14256	FLT992212	FLT24256		29
989222	FLT99222	FLT14256	FLT992222	FLT24256		74

Mfr. Part #	Fleetrite On/Off	On/Off Kit	FLT 2-Speed	2-Speed Kit	Also Use	Pg. #
989223	FLT99223	FLT14256	FLT992232	FLT24256		74
989224	FLT99224	FLT14256	FLT992242	FLT24256		74
989225	FLT99225	FLT14256	FLT992252	FLT24256		74
989226	FLT99226	FLT14256	FLT992262	FLT24256		75
989227	FLT99065	FLT14256	FLT990652	FLT24256		75
989228	FLT99228	FLT14256	FLT992282	FLT24256		73
989229	FLT99229	FLT14256	FLT992292	FLT24256	FLT250SK	75
989230	FLT99230	FLT14256	FLT992302	FLT24256		-
989231	FLT99231	FLT14256	FLT992312	FLT24256		-
989232	FLT99232	FLT14256	FLT992322	FLT24256		58
989233	FLT99233	FLT142561	FLT992332	FLT242561		58
989235	FLT99235	FLT14256	FLT992352	FLT24256	FLT244700	-
989236	FLT99236	FLT14256	FLT992362	FLT24256	FLT244700	-
989238	FLT99238	FLT14256	FLT992382	FLT24256		59
989239	FLT99877	FLT14256	FLT998772	FLT24256		-
989240	FLT99240	FLT14256	FLT992402	FLT24256		29
989241	FLT99241	FLT14256	FLT992412	FLT24256		29
989242	FLT99242	FLT14256	FLT992422	FLT24256		59
989243	FLT99243	FLT14256	FLT992432	FLT24256		75
989246	FLT99246	FLT14256	FLT992462	FLT24256		59
989247	FLT99247	FLT14256	FLT992472	FLT24256		80
989248	FLT99248	FLT142561	FLT992482	FLT242561		59
989251	FLT99251	FLT142561	FLT992512	FLT242561		83
989252	FLT99252	FLT14256	FLT992522	FLT24256		78
989253	FLT99253	FLT14256	FLT992532	FLT24256	FLT350SK	59
989254	FLT99254	FLT14256	FLT992542	FLT24256		-
989255	FLT99255	FLT14256	FLT992552	FLT24256		75
989256	FLT99256	FLT14256	FLT992562	FLT24256	FLT300SK	75
989259	FLT99259	FLT142561	FLT992592	FLT242561		59
989261	FLT99261	FLT14256	FLT992612	FLT24256		-
989262	FLT99262	FLT14256	FLT992622	FLT24256		-
989263	FLT99263	FLT14256	FLT992632	FLT24256		59
989264	FLT99264	FLT14256	FLT992642	FLT24256		59
989266	FLT99266	FLT14256	FLT992662	FLT24256		-
989268	FLT99268	FLT14256	FLT992682	FLT24256		75
989269	FLT99269	FLT14256	FLT992692	FLT24256		29
989270	FLT99270	FLT14256	FLT992702	FLT24256		-
989272	FLT99410	FLT14256	FLT994102	FLT24256		76
989273	FLT99273	FLT14256	FLT992732	FLT24256		29
989274	FLT99274	FLT14256	FLT992742	FLT24256	FLT244700 + FLT250SK	83
989275	FLT99275	FLT142561	FLT992752	FLT242561		60
989277	FLT99277	FLT14256	FLT992772	FLT24256		60
989278	FLT99278	FLT14256	FLT992782	FLT24256		29
989279	FLT99279	FLT14256	FLT992792	FLT24256		34
989280	FLT99387	FLT14256	FLT993872	FLT24256		34
989281	FLT99387	FLT14256	FLT993872	FLT24256		60
989282	FLT99282	FLT142561	FLT992822	FLT242561	FLT200SK	60
989283	FLT99283	FLT14256	FLT992832	FLT24256	FLT200SK	75
989285	FLT99285	FLT14256	FLT992852	FLT24256		-
989286	FLT99286	FLT14200	FLT992862	FLT24256	FLT300SK	30
989289	FLT99289	FLT14256	FLT992892	FLT24256	FLT300SK	30
989291	FLT99291	FLT14256	FLT992912	FLT24256	FLT300SK	24
989292	FLT99070	FLT14256	FLT990702	FLT24256		30
989293	FLT99293	FLT14256	FLT992932	FLT24256		25
989294	FLT99078	FLT14256	FLT990782	FLT24256		60
989295	FLT99295	FLT14256	FLT992952	FLT24256		60
989296	FLT99296	FLT14256	FLT992962	FLT24256	FLT350SK	60
989297	FLT99297	FLT14256	FLT992972	FLT24256		30
989298	FLT99298	FLT14256	FLT992982	FLT24256		30
989300	FLT99300	FLT14256	FLT993002	FLT24256		76
989301	FLT99301	FLT142561	FLT993012	FLT242561		83
989302	FLT99302	FLT142561	FLT993022	FLT242561		84
989303	FLT99303	FLT14256	FLT993032	FLT24256		-
989304	FLT99304	FLT14200	FLT993042	FLT24-200		76
989305	FLT99305	FLT14200	FLT993052	FLT24-200		76
989306	FLT99306	FLT14256	FLT993062	FLT24256		60
989307	FLT99307	FLT14256	FLT993072	FLT24256		30
989309	FLT99309	FLT14256	FLT993092	FLT24256		61
989310	FLT99310	FLT142561	FLT993102	FLT242561		61
989311	FLT99311	FLT142561	FLT993112	FLT242561		30
989313	FLT99313	FLT14256	FLT993132	FLT24256		31
989316	FLT99316	FLT14256	FLT993162	FLT24256		31
989317	FLT99317	FLT14256	FLT993172	FLT24256		31
989318	FLT99318	FLT14256	FLT993182	FLT24256		31

Mfr. Part #	FLT On/Off	On/Off Kit	FLT 2-Speed	2-Speed Kit	Also Use	Pg. #
989319	FLT99319	FLT14256	FLT993192	FLT24256		31
989320	FLT99319	FLT14256	FLT993192	FLT24256		31
989321	FLT99321	FLT14256	FLT993212	FLT24256		-
989322	FLT99322	FLT14256	FLT993222	FLT24256		31
989323	FLT99298	FLT14256	FLT992982	FLT24256		30
989324	FLT99324	FLT14256	FLT993242	FLT24256		61
989325	FLT99325	FLT14256	FLT993252	FLT24256	FLT250SK	61
989326	FLT99326	FLT14256	FLT993262	FLT24256	FLT250SK	61
989327	FLT99327	FLT14256	FLT993272	FLT24256		31
989329	FLT99329	FLT14256	FLT993292	FLT24256		-
989330	FLT99330	FLT14256	FLT993302	FLT24256		31
989331	FLT99331	FLT14256	FLT993312	FLT24256		61
989332	FLT99332	FLT14256	FLT993322	FLT24256	FLT250SK	-
989333	FLT99333	FLT14256	FLT993332	FLT24256		32
989334	FLT99334	FLT14256	FLT993342	FLT24256		32
989335	FLT99335	FLT14256	FLT993352	FLT24256		-
989336	FLT99336	FLT142561	FLT993362	FLT242561		84
989337	FLT99337	FLT14256	FLT993372	FLT24256		32
989339	FLT99339	FLT142561	FLT993392	FLT242561		32
989340	FLT99361	FLT14256	FLT993612	FLT24256		33
989341	FLT99341	FLT142561	FLT993412	FLT242561		32
989342	FLT99298	FLT14256	FLT992982	FLT24256		30
989343	FLT99343	FLT14256	FLT993432	FLT24256		61
989346	FLT99346	FLT14256	FLT993462	FLT24256		32
989347	FLT99494	FLT14256	FLT994942	FLT24256		80
989348	FLT99495	FLT14256	FLT994952	FLT24256		80
989349	FLT99349	FLT14256	FLT993492	FLT24256		61
989350	FLT99350	FLT14256	FLT993502	FLT24256		62
989351	FLT99351	FLT14256	FLT993512	FLT24256		32
989352	FLT99352	FLT14256	FLT993522	FLT24256		62
989353	FLT99353	FLT142561	FLT993532	FLT242561		32
989354	FLT99354	FLT14256	FLT993542	FLT24256		33
989356	FLT99499	FLT14256	FLT994992	FLT24256	FLT250SK	81
989357	FLT99498	FLT14256	FLT994982	FLT24256	FLT250SK	81
989358	FLT99358	FLT142561	FLT993582	FLT242561		33
989359	FLT99359	FLT142561	FLT993592	FLT242561		33
989360	FLT99360	FLT14256	FLT993602	FLT24256		33
989361	FLT99361	FLT14256	FLT993612	FLT24256		33
989362	FLT99362	FLT14256	FLT993622	FLT24256		33
989363	FLT99363	FLT142561	FLT993632	FLT242561		33
989364	FLT99364	FLT14256	FLT993642	FLT24256		-
989365	FLT99365	FLT14256	FLT993652	FLT24256		62
989366	FLT99366	FLT14256	FLT993662	FLT24256		33
989367	FLT99367	FLT142561	FLT993672	FLT242561		34
989368	FLT99368	FLT142561	FLT993682	FLT242561		34
989369	FLT99369	FLT14256	FLT993692	FLT24256		34
989372	FLT99466	FLT14256	FLT994662	FLT24256		63
989373	FLT99465	FLT14256	FLT994652	FLT24256		86
989374	FLT99374	FLT14256	FLT993742	FLT24256		34
989375	FLT99375	FLT14256	FLT993752	FLT24256		-
989377	FLT99377	FLT14256	FLT993772	FLT24256		34
989378	FLT99378	FLT14256	FLT993782	FLT24256		-
989380	FLT99380	FLT14256	FLT993802	FLT24256		-
989381	FLT99381	FLT14256	FLT993812	FLT24256		84
989382	FLT99382	FLT14256	FLT993822	FLT24256		34
989383	FLT99383	FLT14256	FLT993832	FLT24256		-
989384	FLT99384	FLT14256	FLT993842	FLT24256		62
989385	FLT99385	FLT14256	FLT993852	FLT24256		-
989386	FLT99386	FLT14256	FLT993862	FLT24256		34
989387	FLT99387	FLT14256	FLT993872	FLT24256		34
989388	FLT99388	FLT14256	FLT993882	FLT24256		-
989389	FLT99389	FLT14256	FLT993892	FLT24256	FLT250SK	62
989395	FLT99190	FLT14256	FLT991902	FLT24256		28
989396	FLT99191	FLT14256	FLT991912	FLT24256	FLT300SK	28
989398	FLT99398	FLT14256	FLT993982	FLT24256		-
989399	FLT99399	FLT14256	FLT993992	FLT24256		80
989400	FLT99492	FLT14256	FLT994922	FLT24256		80
989401	FLT99401	FLT14256	FLT994012	FLT24256		35
989402	FLT99402	FLT14256	FLT994022	FLT24256		-
989403	FLT99403	FLT14256	FLT994032	FLT24256		35
989404	FLT99404	FLT14256	FLT994042	FLT24256		-
989405	FLT99405	FLT14256	FLT994052	FLT24256		35
989406	FLT99406	FLT14256	FLT994062	FLT24256		-
989407	FLT99407	FLT14256	FLT994072	FLT24256		80
989409	FLT99409	FLT14256	FLT994092	FLT24256		-

Cross Reference Horton-style compatible

Mfr. Part #	Fleetrite On/Off	On/Off Kit	FLT 2-Speed	2-Speed Kit	Also Use	Pg. #
989410	FLT99410	FLT14256	FLT994102	FLT24256		76
989411	FLT99411	FLT142561	FLT994112	FLT242561		35
989412	FLT99412	FLT14256	FLT994122	FLT24256		35
989413	FLT99412	FLT14256	FLT994122	FLT24256		35
989414	FLT99411	FLT142561	FLT994112	FLT242561		35
989415	FLT99415	FLT14256	FLT994152	FLT24256		62
989416	FLT99416	FLT14256	FLT994162	FLT24256	FLT300SK	-
989417	FLT99417	FLT14256	FLT994172	FLT24256		-
989418	FLT99418	FLT14256	FLT994182	FLT24256		-
989419	FLT99419	FLT14200	FLT994192	FLT24-200	FLT200SK	76
989420	FLT99420	FLT14256	FLT994202	FLT24256		35
989421	FLT99421	FLT14256	FLT994212	FLT24256		35
989422	FLT99422	FLT14256	FLT994222	FLT24256		35
989423	FLT99423	FLT14256	FLT994232	FLT24256		80
989424	FLT99202	FLT14256	FLT992022	FLT24256		-
989425	FLT99387	FLT14256	FLT993872	FLT24256		34
989426	FLT99499	FLT14256	FLT994992	FLT24256		81
989427	FLT99498	FLT14256	FLT994982	FLT24256		81
989428	FLT99428	FLT14256	FLT994282	FLT24256		36
989429	FLT99429	FLT14256	FLT994292	FLT24256		76
989430	FLT99430	FLT14256	FLT994302	FLT24256		62
989431	FLT99431	FLT14256	FLT994312	FLT24256		-
989434	FLT99434	FLT14256	FLT994342	FLT24256		-
989435	FLT99387	FLT14256	FLT993872	FLT24256		34
989436	FLT99279	FLT14256	FLT992792	FLT24256		29
989437	FLT99346	FLT14256	FLT993462	FLT24256		32
989438	FLT99438	FLT14256	FLT994382	FLT24256		36
989439	FLT99387	FLT14256	FLT993872	FLT24256		34
989440	FLT99440	FLT14256	FLT994402	FLT24256		36
989444	FLT99444	FLT14256	FLT994442	FLT24256	FLT200SK	-
989445	FLT99445	FLT14256	FLT994452	FLT24256		36
989446	FLT99446	FLT14256	FLT994462	FLT24256		62
989448	FLT99448	FLT14256	FLT994482	FLT24256		-
989450	FLT99450	FLT14256	FLT994502	FLT24256	FLT200SK	76
989451	FLT99451	FLT14256	FLT994512	FLT24256		-
989452	FLT99452	FLT14256	FLT994522	FLT24256		-
989453	FLT99453	FLT142561	FLT994532	FLT242561		36
989454	FLT99454	FLT14256	FLT994542	FLT24256		86
989455	FLT99455	FLT142561	FLT994552	FLT242561		84
989457	FLT99457	FLT14256	FLT994572	FLT24256		36
989458	FLT99458	FLT14256	FLT994582	FLT24256		36
989459	FLT99459	FLT14256	FLT994592	FLT24256	FLT200SK	76
989461	FLT99461	FLT14256	FLT994612	FLT24256		-
989463	FLT99196	FLT14256	FLT991962	FLT24256		86
989465	FLT99465	FLT14256	FLT994652	FLT24256		86
989466	FLT99466	FLT14256	FLT994662	FLT24256		63
989467	FLT99380	FLT14256	FLT993802	FLT24256		-
989468	FLT99431	FLT14256	FLT994312	FLT24256		-
989469	FLT99469	FLT14256	FLT994692	FLT24256		-
989470	FLT99247	FLT14256	FLT992472	FLT24256		80
989471	FLT99492	FLT14256	FLT994922	FLT24256		80
989472	FLT99493	FLT14256	FLT994932	FLT24256		80
989473	FLT99494	FLT14256	FLT994942	FLT24256		80
989474	FLT99495	FLT14256	FLT994952	FLT24256		80
989475	FLT99423	FLT14256	FLT994232	FLT24256		80
989476	FLT99497	FLT14256	FLT994972	FLT24256		81
989477	FLT99498	FLT14256	FLT994982	FLT24256		81
989478	FLT99499	FLT14256	FLT994992	FLT24256		81
989487	FLT99487	FLT14256	FLT994872	FLT24256		80
989491	FLT99247	FLT14256	FLT992472	FLT24256		80
989492	FLT99492	FLT14256	FLT994922	FLT24256		80
989493	FLT99493	FLT14256	FLT994932	FLT24256		80
989494	FLT99494	FLT14256	FLT994942	FLT24256		80
989495	FLT99495	FLT14256	FLT994952	FLT24256		80
989496	FLT99423	FLT14256	FLT994232	FLT24256		80
989499	FLT99499	FLT14256	FLT994992	FLT24256		81
989500	FLT99500	FLT14256	FLT995002	FLT24256		-
989501	FLT99501	FLT14256	FLT995012	FLT24256		36
989502	FLT99502	FLT14256	FLT995022	FLT24256		-
989503	FLT99503	FLT14256	FLT995032	FLT24256	FLT250SK	-
989504	FLT99504	FLT142561	FLT995042	FLT242561		-
989505	FLT99505	FLT14256	FLT995052	FLT24256		-
989506	FLT99506	FLT14256	FLT995062	FLT24256	FLT300SK	37
989508	FLT99508	FLT14256	FLT995082	FLT24256		-
989509	FLT99509	FLT14256	FLT995092	FLT24256	FLT300SK	63

Mfr. Part #	FLT On/Off	On/Off Kit	FLT 2-Speed	2-Speed Kit	Also Use	Pg. #
989510	FLT99510	FLT142561	FLT995102	FLT242561		37
989511	FLT99511	FLT14256	FLT995112	FLT24256	FLT150SK	-
989512	FLT99052	FLT14256	FLT990522	FLT24256		51
989513	FLT99053	FLT14256	FLT990532	FLT24256		51
989514	FLT99514	FLT14256	FLT995142	FLT24256	FLT150SK	-
989515	FLT99188	FLT14256	FLT991882	FLT24256	FLT150SK	57
989517	FLT99517	FLT14256	FLT995172	FLT24256		-
989521	FLT99521	FLT14256	FLT995212	FLT24256		-
989522	FLT99522	FLT14256	FLT995222	FLT24256		-
989523	FLT99523	FLT14256	FLT995232	FLT24256	FLT250SK	37
989525	FLT99525	FLT142561	FLT995252	FLT242561	FLT250SK	37
989526	FLT99526	FLT14256	FLT995262	FLT24256		-
989527	FLT99527	FLT14256	FLT995272	FLT24256		-
989528	FLT99528	FLT142561	FLT995282	FLT242561		37
989529	FLT99529	FLT14256	FLT995292	FLT24256		-
989530	FLT99530	FLT14256	FLT995302	FLT24256	FLT250SK	-
989531	FLT99531	FLT14256	FLT995312	FLT24256	FLT250SK	-
989532	FLT99532	FLT14256	FLT995322	FLT24256		37
989533	FLT99533	FLT14256	FLT995332	FLT24256		-
989534	FLT99534	FLT142561	FLT995342	FLT242561	FLT350SK	-
989537	FLT99537	FLT14256	FLT995372	FLT24256		63
989538	FLT99538	FLT14256	FLT995382	FLT24256	FLT150SK	-
989539	FLT99539	FLT14256	FLT995392	FLT24256		-
989540	FLT99540	FLT14256	FLT995402	FLT24256		-
989542	FLT99542	FLT14256	FLT995422	FLT24256		63
989627	FLT99627	FLT14-500-1	FLT996272	FLT242561		-
989700	-	-	FLT997002	FLT24256		-
989702	-	-	FLT997022	FLT242561		-
989703	-	-	FLT998072	FLT242561		-
989709	-	-	FLT986002	FLT24256		-
989710	-	-	FLT998342	FLT24256		-
989711	-	-	FLT998972	FLT24256		-
989712	-	-	FLT998992	FLT242561		-
989713	-	-	FLT997132	FLT24256		-
989714	-	-	FLT998582	FLT24256		-
989715	-	-	FLT995402	FLT24256		-
989716	-	-	FLT998542	FLT24256		-
989717	-	-	FLT998532	FLT242561		-
989718	-	-	FLT997182	FLT242561		-
989719	-	-	FLT997192	FLT24256		-
989721	-	-	FLT997212	FLT24256		-
989722	-	-	FLT997222	FLT24256		-
989723	-	-	FLT997232	FLT24256		-
989725	-	-	FLT997252	FLT24256		-
989800	FLT99800	FLT14256	FLT998002	FLT24256		64
989801	FLT99801	FLT14256	FLT998012	FLT24256		64
989802	FLT99802	FLT14256	FLT998022	FLT24256		64
989803	FLT99803	FLT14256	FLT998032	FLT24256		64
989804	FLT99466	FLT14256	FLT994662	FLT24256		63
989805	FLT99805	FLT14256	FLT998052	FLT24256		-
989806	FLT99806	FLT14256	FLT998062	FLT24256		-
989807	FLT99807	FLT142561	FLT998072	FLT242561		64
989808	FLT99808	FLT14256	FLT998082	FLT24256		-
989809	FLT99809	FLT14256	FLT998092	FLT24256		37
989810	FLT99810	FLT14256	FLT998102	FLT24256		-
989812	FLT99812	FLT14256	FLT998122	FLT24256		-
989813	FLT99813	FLT14256	FLT998132	FLT24256		-
989815	FLT99815	FLT14256	FLT998152	FLT24256		37
989816	FLT99816	FLT14256	FLT998162	FLT24256		38
989817	FLT99817	FLT14256	FLT998172	FLT24256		-
989818	FLT99818	FLT14256	FLT998182	FLT24256		38
989819	FLT99196	FLT14256	FLT991962	FLT24256		86
989820	FLT99466	FLT14256	FLT994662	FLT24256		63
989821	FLT99821	FLT14256	FLT998212	FLT24256		38
989822	FLT99822	FLT14256	FLT998222	FLT24256		64
989823	FLT99823	FLT14256	FLT998232	FLT24256		64
989824	FLT99824	FLT14256	FLT998242	FLT24256		65
989825	FLT99825	FLT142561	FLT998252	FLT242561		38
989826	FLT99826	FLT14256	FLT998262	FLT24256		-
989827	FLT99827	FLT142561	FLT998272	FLT242561		38
989828	FLT99828	FLT14256	FLT998282	FLT24256		-
989829	FLT99829	FLT14256	FLT998292	FLT24256		38
989830	FLT99830	FLT14256	FLT998302	FLT24256		-
989831	FLT99831	FLT14256	FLT998312	FLT24256		66
989832	FLT99832	FLT14256	FLT998322	FLT24256		-

Mfr. Part #	Fleetrite On/Off	On/Off Kit	FLT 2-Speed	2-Speed Kit	Also Use	Pg. #
989833	FLT99833	FLT14256	FLT998332	FLT24256		-
989834	FLT99834	FLT14256	FLT998342	FLT24256		38
989835	FLT98601	FLT14256	FLT986012	FLT24256		49
989836	FLT99836	FLT142561	FLT998362	FLT242561		38
989837	FLT99837	FLT14256	FLT998372	FLT24256		-
989838	FLT99838	FLT14256	FLT998382	FLT24256		39
989839	FLT98600	FLT14256	FLT986002	FLT24256		49
989840	FLT99840	FLT14256	FLT998402	FLT24256		65
989841	FLT99841	FLT142561	FLT998412	FLT242561		39
989842	FLT99842	FLT14256	FLT998422	FLT24256		65
989843	FLT99843	FLT142561	FLT998432	FLT242561		84
989844	FLT99844	FLT142561	FLT998442	FLT242561		39
989845	FLT99845	FLT14256	FLT998452	FLT24256		65
989846	FLT99846	FLT142561	FLT998462	FLT242561		39
989847	FLT99847	FLT14256	FLT998472	FLT24256		65
989848	FLT99897	FLT14256	FLT998972	FLT24256		66
989849	FLT99849	FLT14256	FLT998492	FLT24256		77
989850	FLT99850	FLT14256	FLT998502	FLT24256		77
989852	FLT99852	FLT14256	FLT998522	FLT24256		82
989853	FLT99853	FLT142561	FLT998532	FLT242561		-
989854	FLT99854	FLT14256	FLT998542	FLT24256		-
989855	FLT99855	FLT14256	FLT998552	FLT24256		39
989856	FLT99856	FLT14256	FLT998562	FLT24256		39
989857	FLT99857	FLT14256	FLT998572	FLT24256		-
989858	FLT99858	FLT14256	FLT998582	FLT24256		-
989859	FLT99859	FLT14256	FLT998592	FLT24256		84
989860	FLT99860	FLT14256	FLT998602	FLT24256		-
989861	FLT99861	FLT14256	FLT998612	FLT24256		-
989862	FLT99862	FLT142561	FLT998622	FLT242561		39
989863	FLT99863	FLT14256	FLT998632	FLT24256		-
989864	FLT99864	FLT14256	FLT998642	FLT24256		65
989865	FLT99865	FLT14256	FLT998652	FLT24256	FLT275SK	65
989866	FLT99866	FLT14256	FLT998662	FLT24256		-
989867	FLT99867	FLT14256	FLT998672	FLT24256		-
989868	FLT99868	FLT14256	FLT998682	FLT24256		65
989869	FLT99869	FLT14256	FLT998692	FLT24256		-
989870	FLT99870	FLT14256	FLT998702	FLT24256		66
989871	FLT99871	FLT14256	FLT998712	FLT24256		66
989872	FLT99872	FLT14256	FLT998722	FLT24256		39
989873	FLT99873	FLT14256	FLT998732	FLT24256		40
989874	FLT99874	FLT14256	FLT998742	FLT24256		40
989875	FLT99875	FLT142561	FLT998752	FLT242561		40
989876	FLT99876	FLT14256	FLT998762	FLT24256		-
989877	FLT99877	FLT14256	FLT998772	FLT24256		-
989878	FLT99187	FLT14256	FLT991872	FLT24256		-
989879	FLT99855	FLT14256	FLT998552	FLT24256		39
989880	FLT99880	FLT14256	FLT998802	FLT24256		-
989881	FLT99881	FLT14256	FLT998812	FLT24256		-
989882	FLT98622	FLT14256	FLT986222	FLT24256		-
989883	FLT99883	FLT142561	FLT998832	FLT242561		-
989884	FLT99884	FLT14256	FLT998842	FLT24256		-
989885	FLT99885	FLT14256	FLT998852	FLT24256		66
989886	FLT99886	FLT14256	FLT998862	FLT24256		40
989887	FLT99887	FLT14256	FLT998872	FLT24256		66
989888	FLT99888	FLT14256	FLT998882	FLT24256	FLT200SK	40
989889	FLT99889	FLT142561	FLT998892	FLT242561		40
989890	FLT99897	FLT14256	FLT998972	FLT24256		66
989891	FLT99834	FLT14256	FLT998342	FLT24256		38
989892	FLT99892	FLT14256	FLT998922	FLT24256		-
989893	FLT99893	FLT142561	FLT998932	FLT242561		84
989894	FLT99894	FLT14256	FLT998942	FLT24256		-
989895	FLT99895	FLT14256	FLT998952	FLT24256		-
989896	FLT99896	FLT142561	FLT998962	FLT242561		-
989897	FLT99897	FLT14256	FLT998972	FLT24256		66
989898	FLT99834	FLT14256	FLT998342	FLT24256		38
989899	FLT99899	FLT142561	FLT998992	FLT242561		40
989900	-	-	FLT999002	FLT24256		-
989901	-	-	FLT999012	FLT242561		-
989902	-	-	FLT999022	FLT24256		-
989904	-	-	FLT999042	FLT242561		-
989905	-	-	FLT999052	FLT24256		-
989906	-	-	FLT999062	FLT24256		-
989907	-	-	FLT999072	FLT24256		-
989908	-	-	FLT999082	FLT24256		-
989909	-	-	FLT999092	FLT24256		-

Mfr. Part #	FLT On/Off	On/Off Kit	FLT 2-Speed	2-Speed Kit	Also Use	Pg. #
989910	-	-	FLT992352	FLT24256	FLT244700	-
989911	-	-	FLT992362	FLT24256	FLT244700	-
989913	-	-	FLT990232	FLT24256		-
989914	-	-	FLT990242	FLT24256		-
989915	-	-	FLT993392	FLT242561		-
989916	-	-	FLT992612	FLT24256		-
989917	-	-	FLT993412	FLT242561		-
989918	-	-	FLT999182	FLT24256	FLT244700	-
989919	-	-	FLT999192	FLT24256		-
989920	-	-	FLT990112	FLT242561		-
989921	-	-	FLT993112	FLT242561		-
989922	-	-	FLT999222	FLT24256		-
989923	-	-	FLT999012	FLT242561		-
989924	-	-	FLT992622	FLT24256		-
989925	-	-	FLT991882	FLT24256		-
989926	-	-	FLT999262	FLT24256		-
989927	-	-	FLT999272	FLT24256		-
989929	-	-	FLT999292	FLT24256		-
989930	-	-	FLT999302	FLT24256		-
989934	-	-	FLT999342	FLT24256		-
989935	-	-	FLT999352	FLT24256		-
989937	-	-	FLT999372	FLT24256		-
989939	-	-	FLT999392	FLT24256		-
989941	-	-	FLT999412	FLT24256		-
989944	-	-	FLT992412	FLT24256		-
989945	-	-	FLT998772	FLT24256		-
989946	-	-	FLT994992	FLT24256		-
989947	-	-	FLT994982	FLT24256		-
989948	-	-	FLT994552	FLT242561		-
989949	-	-	FLT993662	FLT24256		-
989950	-	-	FLT999502	FLT24256		-
989951	-	-	FLT999512	FLT24256		-
989952	-	-	FLT999522	FLT24256		-
989953	-	-	FLT998752	FLT24256		-
989954	-	-	FLT999542	FLT24256		-
989955	-	-	FLT999552	FLT24256		-
989957	-	-	FLT998772	FLT24256		-
989958	-	-	FLT999582	FLT24256		-
989959	-	-	FLT998282	FLT24256		-
989960	-	-	FLT993192	FLT24256		-
989961	-	-	FLT993822	FLT24256		-
989962	-	-	FLT994612	FLT24256		-
989963	-	-	FLT991872	FLT24256		-
989964	-	-	FLT998852	FLT24256		-
989965	-	-	FLT992512	FLT242561		-
989966	-	-	FLT998762	FLT24256		-
989967	-	-	FLT993362	FLT242561		-
989968	-	-	FLT991422	FLT242561		-
989969	-	-	FLT992692	FLT24256		-
989970	-	-	FLT999702	FLT24256		-
989971	-	-	FLT999712	FLT24256		-
989972	-	-	FLT999722	FLT24256		-
989973	-	-	FLT997252	FLT24256		-
989974	-	-	FLT999742	FLT24256		-
989975	-	-	FLT999752	FLT24256		-
989976	-	-	FLT999762	FLT24256		-
989977	-	-	FLT986082	FLT24256		-
989978	-	-	FLT991892	FLT24256		-
989979	-	-	FLT999792	FLT24256		-
989980	-	-	FLT999802	FLT24256		-
989981	-	-	FLT999812	FLT24256		-
989983	-	-	FLT999832	FLT24256		-
989984	-	-	FLT999842	FLT24256		-
989985	-	-	FLT990402	FLT24256		-
989986	-	-	FLT994162	FLT24256		-
989987	-	-	FLT999872	FLT242561		-
989988	-	-	FLT999882	FLT24256		-
989989	-	-	FLT992232	FLT24256		-
989990	-	-	FLT999902	FLT24256		-
989992	-	-	FLT991182	FLT24256		-
989993	-	-	FLT997222	FLT24256		-
989994	-	-	FLT997212	FLT24256		-
989995	-	-	FLT999952	FLT24256		-
989996	-	-	FLT999962	FLT24256		-
989997	-	-	FLT999972	FLT24256		-

Cross Reference Horton-style compatible

Mfr. Part #	Fleetrite On/Off	On/Off Kit	FLT 2-Speed	2-Speed Kit	Also Use	Pg. #
989998	-	-	FLT996782	FLT24256		-
989999	-	-	FLT999992	FLT24256		-
98Axxxx						
98A4700		FLT24256	-	-	FLT244700	-
98A4701		FLT24256	-	-	FLT244700	-
98A4717		FLT24256	-	-	FLT244700	-
98A8104	-	-	FLT995582	FLT24256		-
98A8105	-	-	FLT997542	FLT24256		-
98A8106	-	-	FLT997552	FLT24256		-
98A8107	-	-	FLT997562	FLT24256		-
98A8110	-	-	FLT995952	FLT24256		-
98A8112	-	-	FLT995962	FLT24256		-
98A8121	-	-	FLT981212	FLT24256		-
98A8125	-	-	FLT997912	FLT24256		-
98A8131	FLT99580	FLT14256	FLT995802	FLT24256		-
98A8131-2	-	-	FLT995802	FLT24256		-
98A8136	-	-	FLT996152	FLT24256		-
98A8138	-	-	FLT996172	FLT24256		-
98A8143	-	-	FLT996182	FLT24256		-
98A8145	-	-	FLT996192	FLT24256		-
98A8146	-	-	FLT997572	FLT24256		-
98A8149	-	-	FLT996222	FLT24256		-
98A8177	-	-	FLT997882	FLT24256		-
98A8181	-	-	FLT995582	FLT24256		-
98A8182	-	-	FLT997542	FLT24256		-
98A8183	-	-	FLT997552	FLT24256		-
98A8184	-	-	FLT997562	FLT24256		-
98A8187	-	-	FLT981872	FLT24256		-
98A8188	-	-	FLT996472	FLT24256		-
98A8189	-	-	FLT996492	FLT24256		-
98A8199	-	-	FLT981992	FLT24256		-
98A8210	-	-	FLT986542	FLT24256		-
98A8600	FLT98600	FLT14256	FLT986002	FLT24256		49
98A8601	FLT98601	FLT14256	FLT986012	FLT24256		49
98A8601-2	-	-	FLT986012	FLT24256		-
98A8602	FLT98602	FLT14256	FLT986022	FLT24256		-
98A8603	FLT98603	FLT14256	FLT986032	FLT24256		-
98A8604	FLT98604	FLT14256	FLT986042	FLT24256		78
98A8607	FLT98607	FLT14256	FLT986072	FLT24256		78
98A8607-2	-	-	FLT986072	FLT24256		-
98A8608	FLT98608	FLT14256	FLT986082	FLT24256		-
98A8609	FLT98609	FLT14256	FLT986092	FLT24256		-
98A8610-2	-	-	FLT991602	FLT24256		-
98A8611	FLT98611	FLT14256	FLT986112	FLT24256		-
98A8613	FLT98613	FLT14256	FLT986132	FLT24256		-
98A8616	FLT98616	FLT14256	FLT986162	FLT24256		-
98A8620	FLT98620	FLT14256	FLT986202	FLT24256		70
98A8621	FLT98621	FLT14256	FLT986212	FLT24256		70
98A8621-2	-	-	FLT986212	FLT24256		-
98A8624-2	-	-	FLT986242	FLT24256	FLT300SK	-
98A8627	FLT98627	FLT14256	FLT986272	FLT24256		85
98A8631	FLT98631	FLT14256	FLT986312	FLT24256		85
98A8634	FLT98634	FLT14256	FLT986342	FLT24256		-
98A8635	FLT98635	FLT14256	FLT986352	FLT24256		78
98A8638	FLT98638	FLT14256	FLT986382	FLT24256		83
98A8639	FLT99352	FLT14256	FLT993522	FLT24256		62
98A8640	FLT99254	FLT14256	FLT992542	FLT24256		-
98A8642	FLT98642	FLT14256	FLT986422	FLT24256		-
98A8643	FLT98643	FLT14256	FLT986432	FLT24256		-
98A8646	FLT98646	FLT14256	FLT986462	FLT24256		-
98A8647	FLT98647	FLT14256	FLT986472	FLT24256		23
98A8648	FLT98648	FLT14256	FLT986482	FLT24256		-
98A8650	FLT98650	FLT14256	FLT986502	FLT24256		70
98A8652	FLT98652	FLT14256	FLT986522	FLT24256		-
98A8652-2	-	-	FLT986522	FLT24256		-
98A8653	FLT98653	FLT14256	FLT986532	FLT24256		-
98A8653-2	-	-	FLT986532	FLT24256		-
98A8654	FLT98654	FLT14256	FLT986542	FLT24256		-
98A8654-2	-	-	FLT986542	FLT24256		-
98A8655	FLT98655	FLT14256	FLT986552	FLT24256		70
98A8655-2	-	-	FLT986552	FLT24256		-
98A8656	FLT98656	FLT14256	FLT986562	FLT24256		-
98A8657	FLT98657	FLT14256	FLT986572	FLT24256		-
98A8657-2	-	-	FLT986572	FLT24256		-
98A9007	FLT99007	FLT14256	FLT990072	FLT24256		71

Mfr. Part #	FLT On/Off	On/Off Kit	FLT 2-Speed	2-Speed Kit	Also Use	Pg. #
98A9023	FLT99023	FLT14256	FLT990232	FLT24256		78
98A9024	FLT99024	FLT14256	FLT990242	FLT24256		78
98A9037	FLT99037	FLT14256	FLT990372	FLT24256		24
98A9044	FLT99044	FLT14256	FLT990442	FLT24256		24
98A9046	FLT99046	FLT14256	FLT990462	FLT24256		24
98A9054	FLT99054	FLT14256	FLT990542	FLT24256		51
98A9054-2	-	-	FLT990542	FLT24256		-
98A9056	FLT99056	FLT14256	FLT990562	FLT24256		52
98A9057	FLT99057	FLT14256	FLT990572	FLT24256		52
98A9061	FLT99061	FLT14256	FLT990612	FLT24256		72
98A9062	FLT99062	FLT14256	FLT990622	FLT24256		72
98A9062-2	-	-	FLT990622	FLT24256		-
98A9064	FLT99064	FLT14256	FLT990642	FLT24256		72
98A9064-2	-	-	FLT990642	FLT24256		-
98A9065	FLT99065	FLT14256	FLT990652	FLT24256		73
98A9065-2	-	-	FLT990652	FLT24256		-
98A9067	FLT99067	FLT14256	FLT990672	FLT24256		-
98A9067-2	-	-	FLT990672	FLT24256		-
98A9074	FLT99074	FLT14256	FLT990742	FLT24256		25
98A9074-2	-	-	FLT990742	FLT24256		-
98A9087	FLT99087	FLT14256	FLT990872	FLT24256		-
98A9088-2	-	-	FLT990882	FLT24256		-
98A9097	FLT99097	FLT14256	FLT990972	FLT24256		53
98A9110	FLT99110	FLT14256	FLT991102	FLT24256	FLT350SK	54
98A9112	FLT99112	FLT14256	FLT991122	FLT24256		54
98A9132	FLT99576	FLT14256	FLT995762	FLT24256		-
98A9133	FLT99133	FLT14256	FLT991332	FLT24256		56
98A9134	FLT99134	FLT14256	FLT991342	FLT24256		56
98A9146	FLT99146	FLT14256	FLT991462	FLT24256		73
98A9147	FLT99147	FLT14256	FLT991472	FLT24256		-
98A9161	FLT99161	FLT14256	FLT991612	FLT24256		27
98A9165	FLT99165	FLT14256	FLT991652	FLT24256		-
98A9166	FLT99166	FLT14256	FLT991662	FLT24256		-
98A9168	FLT99168	FLT14256	FLT991682	FLT24256		57
98A9189	FLT99189	FLT14256	FLT991892	FLT24256		27
98A9191	FLT99191	FLT14256	FLT991912	FLT24256	FLT300SK	28
98A9194	FLT99194	FLT14256	FLT991942	FLT24256		28
98A9198	FLT99198	FLT14256	FLT991982	FLT24256		58
98A9216	FLT99216	FLT14256	FLT992162	FLT24256	FLT250SK	74
98A9222-2	-	-	FLT992222	FLT24256		-
98A9223	FLT99223	FLT14256	FLT992232	FLT24256		74
98A9223-2	-	-	FLT992232	FLT24256		-
98A9235	FLT99235	FLT14256	FLT992352	FLT24256	FLT244700	-
98A9238	FLT99238	FLT14256	FLT992382	FLT24256		59
98A9254	FLT99254	FLT14256	FLT992542	FLT24256		-
98A9256	FLT99256	FLT14256	FLT992562	FLT24256	FLT300SK	75
98A9261	FLT99261	FLT14256	FLT992612	FLT24256		-
98A9263	FLT99263	FLT14256	FLT992632	FLT24256		59
98A9263-2	-	-	FLT992632	FLT24256		-
98A9264	FLT99264	FLT14256	FLT992642	FLT24256		59
98A9268	FLT99268	FLT14256	FLT992682	FLT24256		75
98A9285	FLT99285	FLT14256	FLT992852	FLT24256		75
98A9292	FLT99070	FLT14256	FLT990702	FLT24256		24
98A9293-2	-	-	FLT992932	FLT24256		-
98A9307	FLT99307	FLT14256	FLT993072	FLT24256		30
98A9319	FLT99319	FLT14256	FLT993192	FLT24256		31
98A9324	FLT99324	FLT14256	FLT993242	FLT24256		61
98A9334	FLT99334	FLT14256	FLT993342	FLT24256		32
98A9335	FLT99335	FLT14256	FLT993352	FLT24256		-
98A9346	FLT99346	FLT14256	FLT993462	FLT24256		32
98A9360	FLT99360	FLT14256	FLT993602	FLT24256		33
98A9361	FLT99361	FLT14256	FLT993612	FLT24256		33
98A9362	FLT99362	FLT14256	FLT993622	FLT24256		33
98A9366	FLT99366	FLT14256	FLT993662	FLT24256		33
98A9377	FLT99377	FLT14256	FLT993772	FLT24256		34
98A9381	FLT99381	FLT14256	FLT993812	FLT24256		84
98A9383-2	-	-	FLT993832	FLT24256		-
98A9404	FLT99404	FLT14256	FLT994042	FLT24256		-
98A9405	FLT99405	FLT14256	FLT994052	FLT24256		35
98A9410	FLT99410	FLT14256	FLT994102	FLT24256		76
98A9410-2	-	-	FLT994102	FLT24256		-
98A9428	FLT99428	FLT14256	FLT994282	FLT24256		36
98A9437	FLT99346	FLT14256	FLT993462	FLT24256		32
98A9446	FLT99446	FLT14256	FLT994462	FLT24256		62
98A9451	FLT99451	FLT14256	FLT994512	FLT24256		-

Mfr. Part #	Fleetrite On/Off	On/Off Kit	FLT 2-Speed	2-Speed Kit	Also Use	Pg. #
98A9461	FLT99461	FLT14256	FLT994612	FLT24256	-	-
98A9502	FLT99502	FLT14256	FLT995022	FLT24256	-	-
98A9502-2	-	-	FLT995022	FLT24256	-	-
98A9505	FLT99505	FLT14256	FLT995052	FLT24256	-	-
98A9506	FLT99506	FLT14256	FLT995062	FLT24256	-	37
98A9509	FLT99509	FLT14256	FLT995092	FLT24256	FLT300SK	63
98A9511	FLT99511	FLT14256	FLT995112	FLT24256	-	-
98A9512	FLT99512	FLT14256	FLT995122	FLT24256	-	51
98A9512-2	-	-	FLT995122	FLT24256	-	-
98A9515	FLT99188	FLT14256	FLT991882	FLT24256	-	57
98A9521	FLT99521	FLT14256	FLT995212	FLT24256	-	-
98A9521-2	-	-	FLT995212	FLT24256	-	-
98A9522	FLT99522	FLT14256	FLT995222	FLT24256	-	-
98A9526	FLT99526	FLT14256	FLT995262	FLT24256	-	-
98A9529	FLT99529	FLT14256	FLT995292	FLT24256	-	-
98A9531	FLT99531	FLT14256	FLT995312	FLT24256	FLT250SK	-
98A9542	FLT99542	FLT14256	FLT995422	FLT24256	-	63
98A9547	FLT99547	FLT14256	FLT995472	FLT24256	-	-
98A9547-2	-	-	FLT995472	FLT24256	-	-
98A9548	FLT99548	FLT14256	FLT995482	FLT24256	-	63
98A9551	FLT99551	FLT14256	FLT995512	FLT24256	-	-
98A9552	FLT99552	FLT14256	FLT995522	FLT24256	-	-
98A9553	FLT99553	FLT14256	FLT995532	FLT24256	-	-
98A9553-2	-	-	FLT995532	FLT24256	-	-
98A9554	FLT99554	FLT14256	FLT995542	FLT24256	-	-
98A9554-2	-	-	FLT995542	FLT24256	-	-
98A9555	FLT99555	FLT14200	FLT995552	FLT24-200	-	-
98A9555-2	-	-	FLT995552	FLT24-200	-	-
98A9556	FLT99556	FLT14200	FLT995562	FLT24-200	-	-
98A9556-2	-	-	FLT995562	FLT24-200	-	-
98A9557	FLT99557	FLT14200	FLT995572	FLT24-200	-	-
98A9557-2	-	-	FLT995572	FLT24-200	-	-
98A9558	-	-	FLT995582	FLT24256	-	-
98A9559	FLT99559	FLT14256	FLT995592	FLT24256	-	-
98A9559-2	-	-	FLT995592	FLT24256	-	-
98A9560	FLT99560	FLT14256	FLT995602	FLT24256	-	-
98A9562	FLT99562	FLT14256	FLT995622	FLT24256	-	78
98A9562-2	-	-	FLT995622	FLT24256	-	-
98A9569	FLT99569	FLT14256	FLT995692	FLT24256	-	-
98A9569-2	-	-	FLT995692	FLT24256	-	-
98A9570	FLT99570	FLT14256	FLT995702	FLT24256	-	77
98A9570-2	-	-	FLT995702	FLT24256	-	-
98A9574	FLT99574	FLT14256	FLT995742	FLT24256	-	-
98A9575	FLT99575	FLT14256	FLT995752	FLT24256	-	-
98A9576	FLT99576	FLT14256	FLT995762	FLT24256	-	-
98A9576-2	-	-	FLT995762	FLT24256	-	-
98A9577	FLT99577	FLT14256	FLT995772	FLT24256	-	-
98A9578	FLT99578	FLT14256	FLT995782	FLT24256	-	-
98A9579	FLT99579	FLT14256	FLT995792	FLT24256	-	-
98A9580	FLT99580	FLT14256	FLT995802	FLT24256	-	-
98A9581	FLT99581	FLT14256	FLT995812	FLT24256	-	-
98A9581-2	-	-	FLT995812	FLT24256	-	-
98A9584	FLT99584	FLT14256	FLT995842	FLT24256	-	-
98A9584-2	-	-	FLT995842	FLT24256	-	-
98A9585	FLT99585	FLT14256	FLT995852	FLT24256	-	-
98A9586	FLT99586	FLT14-500	FLT995862	FLT24256	-	-
98A9589	FLT99589	FLT14-500	FLT995892	FLT24256	-	-
98A9590	FLT99590	FLT14-500	FLT995902	FLT24256	-	85
98A9591	FLT99591	FLT14-500	FLT995912	FLT24256	-	-
98A9592	FLT99592	FLT14-500	FLT995922	FLT24256	-	85
98A9594	FLT99594	FLT14-500	FLT995942	FLT24256	-	-
98A9595	FLT99595	FLT14-500	FLT995952	FLT24256	-	-
98A9596	FLT99596	FLT14-500	FLT995962	FLT24256	-	-
98A9599	FLT99599	FLT14256	FLT995992	FLT24256	FLT350SK	-
98A9600	FLT99600	FLT14256	FLT996002	FLT24256	-	-
98A9600-2	-	-	FLT996002	FLT24256	-	-
98A9601	FLT99601	FLT14256	FLT996012	FLT24256	-	-
98A9610	FLT99610	FLT14256	FLT996102	FLT24256	-	-
98A9610-2	-	-	FLT996102	FLT24256	-	-
98A9611	FLT99611	FLT14256	FLT996112	FLT24256	-	-
98A9612	FLT99612	FLT14-500	FLT996122	FLT24256	-	63
98A9613	FLT99383	FLT14256	FLT993832	FLT24256	-	-
98A9614	FLT99614	FLT14-500	FLT996142	FLT24256	-	-
98A9615	FLT99615	FLT14-500	FLT996152	FLT24256	-	-
98A9616	FLT99616	FLT14-500	FLT996162	FLT24256	FLT250SK	-

Mfr. Part #	FLT On/Off	On/Off Kit	FLT 2-Speed	2-Speed Kit	Also Use	Pg. #
98A9617	FLT99617	FLT14-500	FLT996172	FLT24256	-	-
98A9618	FLT99618	FLT14-500	FLT996182	FLT24256	-	-
98A9619	FLT99619	FLT14256	FLT996192	FLT24256	-	-
98A9620	FLT99620	FLT14256	FLT996202	FLT24256	-	77
98A9621	FLT99621	FLT14256	FLT996212	FLT24256	-	77
98A9622	FLT99622	FLT14-500	FLT996222	FLT24256	-	-
98A9624	FLT99624	FLT142561	FLT996242	FLT242561	FLT244700	-
98A9625	-	-	FLT999702	FLT24256	-	-
98A9626	FLT99643	FLT14256	FLT996432	FLT24256	-	-
98A9628	FLT99628	FLT14256	FLT996282	FLT24256	-	-
98A9629	FLT99629	FLT14256	FLT996292	FLT24256	-	-
98A9630	FLT99630	FLT14256	FLT996302	FLT24256	-	63
98A9632	FLT99632	FLT14256	FLT996322	FLT24256	-	63
98A9633	-	-	FLT996332	FLT24256	-	-
98A9634	-	-	FLT996342	FLT24256	-	-
98A9635	-	-	FLT996352	FLT24256	-	-
98A9636	-	-	FLT996362	FLT24256	-	-
98A9637	FLT99637	FLT14-500	FLT996372	FLT24256	-	-
98A9638	FLT99638	FLT14-500	FLT996382	FLT24256	-	-
98A9639	FLT99639	FLT14-500	FLT996392	FLT24256	FLT200SK	-
98A9640	FLT99640	FLT14-500	FLT996402	FLT24256	FLT200SK	-
98A9641	FLT99641	FLT14256	FLT996412	FLT24256	-	-
98A9642	FLT99642	FLT14256	FLT996422	FLT24256	-	-
98A9642-2	-	-	FLT996422	FLT24256	-	-
98A9643	FLT99643	FLT14256	FLT996432	FLT24256	-	-
98A9643-2	-	-	FLT996432	FLT24256	-	-
98A9644	FLT99552	FLT14256	FLT995522	FLT24256	-	-
98A9644-2	-	-	FLT995522	FLT24256	-	-
98A9645	FLT99553	FLT14256	FLT995532	FLT24256	-	-
98A9645-2	-	-	FLT995532	FLT24256	-	-
98A9646	FLT99554	FLT14256	FLT995542	FLT24256	-	-
98A9646-2	-	-	FLT995542	FLT24256	-	-
98A9647	FLT99647	FLT14-500	FLT996472	FLT24256	-	-
98A9648	FLT99648	FLT14200	FLT996482	FLT24-200	-	77
98A9649	FLT99649	FLT14-500	FLT996492	FLT24256	-	-
98A9650	FLT98621	FLT14256	FLT986212	FLT24256	-	70
98A9651	FLT99651	FLT14256	FLT996512	FLT24256	FLT250SK	-
98A9656	FLT99656	FLT14-500	FLT996562	FLT24256	-	-
98A9656-2	-	-	FLT996562	FLT24256	-	-
98A9659	FLT99586	FLT14-500	FLT995862	FLT24256	-	-
98A9660	FLT99589	FLT14-500	FLT995892	FLT24256	-	-
98A9661	FLT99833	FLT14256	FLT998332	FLT24256	-	-
98A9662	FLT99662	FLT14-500	FLT996622	FLT24256	-	-
98A9662-2	-	-	FLT996622	FLT24256	-	-
98A9663	FLT99663	FLT14256	FLT996632	FLT24256	-	64
98A9664	FLT99664	FLT14-500	FLT996642	FLT24256	-	-
98A9665	FLT99665	FLT14-500	FLT996652	FLT24256	-	-
98A9678	FLT99678	FLT14-500	FLT996782	FLT24256	-	-
98A9700	-	-	FLT997002	FLT24256	-	-
98A9709	-	-	FLT986002	FLT24256	-	-
98A9710	-	-	FLT998342	FLT24256	-	-
98A9711	-	-	FLT998972	FLT24256	-	-
98A9714	-	-	FLT998582	FLT24256	-	-
98A9715	-	-	FLT995402	FLT24256	-	-
98A9729	-	-	FLT995042	FLT242561	-	-
98A9731	-	-	FLT998452	FLT24256	-	-
98A9732	-	-	FLT997322	FLT24256	-	-
98A9736	-	-	FLT997362	FLT24256	-	-
98A9737	-	-	FLT986562	FLT24256	-	-
98A9740	-	-	FLT995602	FLT24256	-	-
98A9742	-	-	FLT997422	FLT24256	-	-
98A9743	-	-	FLT997432	FLT24256	-	-
98A9744	-	-	FLT997442	FLT24256	-	-
98A9745	-	-	FLT997452	FLT24256	-	-
98A9746	-	-	FLT986502	FLT24256	-	-
98A9747	-	-	FLT997472	FLT24256	-	-
98A9748	-	-	FLT997482	FLT24256	-	-
98A9749	-	-	FLT986092	FLT24256	-	-
98A9750	-	-	FLT998332	FLT24256	-	-
98A9751	FLT99751	FLT14256	FLT997512	FLT24256	-	-
98A9751-2	-	-	FLT997512	FLT24256	-	-
98A9754	-	-	FLT997542	FLT24256	-	-
98A9755	-	-	FLT997552	FLT24256	-	-
98A9756	-	-	FLT997562	FLT24256	-	-
98A9757	-	-	FLT997572	FLT24256	-	-

Cross Reference Horton-style compatible

Mfr. Part #	Fleetrite On/Off	On/Off Kit	FLT 2-Speed	2-Speed Kit	Also Use	Pg. #
98A9760	-	-	FLT997602	FLT24256	-	-
98A9761	-	-	FLT995902	FLT24256	-	-
98A9762	-	-	FLT995922	FLT24256	-	-
98A9763	-	-	FLT995912	FLT24256	-	-
98A9764	-	-	FLT997642	FLT24256	-	-
98A9766	-	-	FLT997662	FLT24256	-	-
98A9767	-	-	FLT997672	FLT24256	-	-
98A9768	-	-	FLT995942	FLT24256	-	-
98A9770	-	-	FLT997702	FLT24256	-	-
98A9771	-	-	FLT997712	FLT24256	-	-
98A9774	-	-	FLT997742	FLT24256	-	-
98A9775	-	-	FLT997752	FLT24256	-	-
98A9776	-	-	FLT997762	FLT24256	-	-
98A9777	-	-	FLT996392	FLT24256	FLT200SK	-
98A9778	FLT99778	FLT14256	FLT997782	FLT24256	-	-
98A9778-2	-	-	FLT997782	FLT24256	-	-
98A9779	FLT99779	FLT14256	FLT997792	FLT24256	-	-
98A9779-2	-	-	FLT997792	FLT24256	-	-
98A9780	-	-	FLT995772	FLT24256	-	-
98A9781	-	-	FLT997812	FLT24256	-	-
98A9782	-	-	FLT997822	FLT24256	-	-
98A9783	-	-	FLT997832	FLT24256	-	-
98A9786	-	-	FLT997862	FLT24256	-	-
98A9787	-	-	FLT997872	FLT24256	-	-
98A9788	-	-	FLT997882	FLT24256	-	-
98A9789	-	-	FLT997892	FLT24256	-	-
98A9790	-	-	FLT997902	FLT24256	-	-
98A9791	-	-	FLT997912	FLT24256	-	-
98A9792	-	-	FLT996652	FLT24256	-	-
98A9793	-	-	FLT997932	FLT24256	-	-
98A9794	-	-	FLT997942	FLT24256	-	-
98A9795	-	-	FLT997952	FLT24256	-	-
98A9796	-	-	FLT997962	FLT24256	-	-
98A9797	-	-	FLT996432	FLT24256	-	-
98A9798	-	-	FLT995892	FLT24256	-	-
98A9799	-	-	FLT997992	FLT24256	-	-
98A9801	FLT99801	FLT14256	FLT998012	FLT24256	-	64
98A9807	FLT99807	FLT142561	FLT998072	FLT242561	-	64
98A9816	FLT99816	FLT14256	FLT998162	FLT24256	-	38
98A9817	FLT99817	FLT14256	FLT998172	FLT24256	-	-
98A9818	FLT99818	FLT14256	FLT998182	FLT24256	-	38
98A9829	FLT99829	FLT14256	FLT998292	FLT24256	-	38
98A9830	FLT99830	FLT14256	FLT998302	FLT24256	-	-
98A9833	FLT99833	FLT14256	FLT998332	FLT24256	-	-
98A9837	FLT99837	FLT14256	FLT998372	FLT24256	-	-
98A9840	FLT99840	FLT14256	FLT998402	FLT24256	-	65
98A9842	FLT99842	FLT14256	FLT998422	FLT24256	-	65
98A9845	FLT99845	FLT14256	FLT998452	FLT24256	-	65
98A9847	FLT99847	FLT14256	FLT998472	FLT24256	-	65
98A9855	FLT99855	FLT14256	FLT998552	FLT24256	-	39
98A9856	FLT99856	FLT14256	FLT998562	FLT24256	-	39
98A9858	FLT99858	FLT14256	FLT998582	FLT24256	-	-
98A9859	FLT99859	FLT14256	FLT998592	FLT24256	-	84
98A9861	FLT99861	FLT14256	FLT998612	FLT24256	-	-
98A9863	FLT99863	FLT14256	FLT998632	FLT24256	-	-
98A9864	FLT99864	FLT14256	FLT998642	FLT24256	-	65
98A9865	FLT99865	FLT14256	FLT998652	FLT24256	-	65
98A9867	FLT99867	FLT14256	FLT998672	FLT24256	-	-
98A9867-2	-	-	FLT998672	FLT24256	-	-
98A9868	FLT99868	FLT14256	FLT998682	FLT24256	-	65
98A9870	FLT99870	FLT14256	FLT998702	FLT24256	-	66
98A9871	FLT99871	FLT14256	FLT998712	FLT24256	-	66
98A9872	FLT99872	FLT14256	FLT998722	FLT24256	-	39
98A9873	FLT99873	FLT14256	FLT998732	FLT24256	-	40
98A9874	FLT99874	FLT14256	FLT998742	FLT24256	-	40
98A9875	-	-	FLT997862	FLT24256	-	-
98A9876	FLT99876	FLT14256	FLT998762	FLT24256	-	-
98A9877	FLT99877	FLT14256	FLT998772	FLT24256	-	-
98A9879	FLT99855	FLT14256	FLT998552	FLT24256	-	39
98A9885	FLT99885	FLT14256	FLT998852	FLT24256	-	66
98A9886	FLT99886	FLT14256	FLT998862	FLT24256	-	40
98A9887	FLT99887	FLT14256	FLT998872	FLT24256	-	66
98A9892	FLT99892	FLT14256	FLT998922	FLT24256	-	-
98A9897	FLT99897	FLT14256	FLT998972	FLT24256	-	-
98A9898	FLT99834	FLT14256	FLT998342	FLT24256	-	38

Mfr. Part #	FLT On/Off	On/Off Kit	FLT 2-Speed	2-Speed Kit	Also Use	Pg. #
98A9906	-	-	FLT999002	FLT24256	-	-
98A9907	-	-	FLT999022	FLT24256	-	-
98A9914	-	-	FLT990242	FLT24256	-	-
98A9916	-	-	FLT992612	FLT24256	-	-
98A9918	-	-	FLT999182	FLT24256	FLT244700	-
98A9924	-	-	FLT992622	FLT24256	-	-
98A9925	-	-	FLT991882	FLT24256	-	-
98A9950	-	-	FLT999502	FLT24256	-	-
98A9953	-	-	FLT998752	FLT24256	-	-
98A9957	-	-	FLT998772	FLT24256	-	-
98A9962	-	-	FLT994612	FLT24256	-	-
98A9963	-	-	FLT991872	FLT24256	-	-
98A9964	-	-	FLT998852	FLT24256	-	-
98A9966	-	-	FLT998762	FLT24256	-	-
98A9970	-	-	FLT999702	FLT24256	-	-
98A9972	-	-	FLT999722	FLT24256	-	-
98A9974	-	-	FLT998502	FLT24256	-	-
98A9977	-	-	FLT998082	FLT24256	-	-
98A9979	-	-	FLT999792	FLT24256	-	-
98A9984	-	-	FLT999842	FLT24256	-	-
98A9988	-	-	FLT999882	FLT24256	-	-
98A9990	-	-	FLT999902	FLT24256	-	-
98A9993	-	-	FLT997222	FLT24256	-	-
98A9994	-	-	FLT997212	FLT24256	-	-
98A9995	-	-	FLT999952	FLT24256	-	-
98A9996	-	-	FLT999962	FLT24256	-	-
98A9998	-	-	FLT996782	FLT24256	-	-
99xxxx						
990000	Use Kit	FLT7500HP	-	-	-	-
990001	Use Kit	FLT7500HP	-	-	-	-
990002	Use Kit	FLT7500HP	-	-	-	-
990003	FLT90023	FLT7500HP	-	-	-	42
990004	FLT90023	FLT7500HP	-	-	-	42
990005	FLT90023	FLT7500HP	-	-	-	42
990006	FLT90010	FLT7500HP	-	-	-	41
990007	FLT90017	FLT7500HP	-	-	-	42
990008	FLT90010	FLT7500HP	-	-	-	41
990009	Use Kit	FLT7500HP	-	-	-	-
990010	Use Kit	FLT7500HP	-	-	-	-
990011	Use Kit	FLT7500HP	-	-	-	-
990012	FLT90000	FLT7500HP	-	-	-	41
990013	FLT90000	FLT7500HP	-	-	-	41
990014	FLT90000	FLT7500HP	-	-	-	41
990015	FLT90000	FLT7500HP	-	-	-	41
990016	Use Kit	FLT7500HP	-	-	-	-
990017	Use Kit	FLT7500HP	-	-	-	-
990018	FLT90000	FLT7500HP	-	-	-	41
990019	FLT90008	FLT7500HP	-	-	-	41
990020	Use Kit	FLT7500HP	-	-	-	-
990021	Use Kit	FLT7500HP	-	-	-	-
990022	Use Kit	FLT7500HP	-	-	-	-
990023	FLT90001	FLT7500HP	-	-	-	41
990024	FLT90001	FLT7500HP	-	-	-	41
990025	FLT90002	FLT7500HP	-	-	-	41
990026	FLT90002	FLT7500HP	-	-	-	41
990027	Use Kit	FLT7500HP	-	-	-	-
990028	Use Kit	FLT7500HP	-	-	-	-
990029	Use Kit	FLT7500HP	-	-	-	-
990030	FLT90003	FLT7500HP	-	-	-	67
990031	FLT90003	FLT7500HP	-	-	-	67
990032	FLT90003	FLT7500HP	-	-	-	67
990034	FLT90003	FLT7500HP	-	-	-	67
990035	Use Kit	FLT7500HP	-	-	-	-
990036	Use Kit	FLT7500HP	-	-	-	-
990037	Use Kit	FLT7500HP	-	-	-	-
990038	Use Kit	FLT7500HP	-	-	-	-
990039	Use Kit	FLT7500HP	-	-	-	-
990040	FLT90011	FLT7500HP	-	-	-	67
990041	FLT90009	FLT7500HP	-	-	-	67
990042	Use Kit	FLT7500HP	-	-	-	-
990043	Use Kit	FLT7500HP	-	-	-	-
990044	Use Kit	FLT7500HP	-	-	-	-
990045	Use Kit	FLT7500HP	-	-	-	-
990046	Use Kit	FLT7500HP	-	-	-	-
990047	FLT90004	FLT7500HP	-	-	-	67

Mfr. Part #	Fleetrite On/Off	On/Off Kit	FLT 2-Speed	2-Speed Kit	Also Use	Pg. #
990048	FLT90004	FLT7500HP	-	-		67
990049	FLT90004	FLT7500HP	-	-		67
990050	Use Kit	FLT7500HP	-	-		-
990051	Use Kit	FLT7500HP	-	-		-
990052	Use Kit	FLT7500HP	-	-		-
990053	Use Kit	FLT7500HP	-	-		-
990054	Use Kit	FLT7500HP	-	-		-
990055	Use Kit	FLT7500HP	-	-		-
990056	Use Kit	FLT7500HP	-	-		-
990057	FLT90022	FLT7500HP	-	-		17
990058	FLT90005	FLT7500HP	-	-		17
990059	FLT90005	FLT7500HP	-	-		17
990060	FLT90005	FLT7500HP	-	-		17
990061	FLT90005	FLT7500HP	-	-		17
990062	FLT90007	FLT7500HP	-	-		17
990063	FLT90005	FLT7500HP	-	-		17
990064	Use Kit	FLT7500HP	-	-		-
990065	Use Kit	FLT7500HP	-	-		-
990066	Use Kit	FLT7500HP	-	-		-
990067	FLT90004	FLT7500HP	-	-		67
990069	Use Kit	FLT7500HP	-	-		-
990070	FLT90007	FLT7500HP	-	-		17
990071	Use Kit	FLT7500HP	-	-		-
990072	Use Kit	FLT7500HP	-	-		-
990073	Use Kit	FLT7500HP	-	-		-
990074	Use Kit	FLT7500HP	-	-		-
990075	FLT90012	FLT7500HP	-	-		41
990076	FLT90005	FLT7500HP	-	-		17
990077	FLT90009	FLT7500HP	-	-		67
990078	FLT91115	FLT9505SP	-	-		22
990079	Use Kit	FLT7500HP	-	-		-
990080	FLT90013	FLT7500HP	-	-		41
990081	FLT90014	FLT7500HP	-	-		17
990082	Use Kit	FLT7500HP	-	-		-
990083	FLT90015	FLT7500HP	-	-		17
990084	Use Kit	FLT7500HP	-	-		-
990085	Use Kit	FLT7500HP	-	-		-
990086	FLT91011	FLT9500HP	-	-		68
990086	Use Kit	FLT7500HP	-	-		-
990087	Use Kit	FLT7500HP	-	-		-
990088	Use Kit	FLT7500HP	-	-		-
990089	FLT90014	FLT7500HP	-	-		17
990090	Use Kit	FLT7500HP	-	-		-
990091	FLT90015	FLT7500HP	-	-		17
990092	FLT90016	FLT7500HP	-	-		41
990093	Use Kit	FLT7500HP	-	-		-
990094	Use Kit	FLT7500HP	-	-		-
990095	Use Kit	FLT7500HP	-	-		-
990096	Use Kit	FLT7500HP	-	-		-
990097	Use Kit	FLT7500HP	-	-		-
990098	FLT90014	FLT7500HP	-	-		17
990099	FLT90018	FLT7500HP	-	-		67
990100	Use Kit	FLT7500HP	-	-		-
990101	Use Kit	FLT7500HP	-	-		-
990102	FLT90002	FLT7500HP	-	-		41
990105	FLT90019	FLT7500HP	-	-		67
990106	FLT90022	FLT7500HP	-	-		17
990107	Use Kit	FLT7500HP	-	-		-
990108	Use Kit	FLT7500HP	-	-		-
990110	Use Kit	FLT7500HP	-	-		-
990111	FLT90021	FLT7500HP	-	-		42
990112	FLT90019	FLT7500HP	-	-		67
990113	FLT90021	FLT7500HP	-	-		42
990114	Use Kit	FLT7500HP	-	-		-
990115	Use Kit	FLT7500HP	-	-		-
990116	Use Kit	FLT7500HP	-	-		-
990117	FLT90017	FLT7500HP	-	-		42
990118	FLT90015	FLT7500HP	-	-		17
990119	Use Kit	FLT7500HP	-	-		-
990121	FLT90022	FLT7500HP	-	-		17
990122	FLT90010	FLT7500HP	-	-		41
990123	FLT90018	FLT7500HP	-	-		67
990124	FLT90013	FLT7500HP	-	-		41
990125	FLT90017	FLT7500HP	-	-		42
990126	FLT90004	FLT7500HP	-	-		67

Mfr. Part #	FLT On/Off	On/Off Kit	FLT 2-Speed	2-Speed Kit	Also Use	Pg. #
990127	Use Kit	FLT7500HP	-	-		-
990128	Use Kit	FLT7500HP	-	-		-
990129	FLT90014	FLT7500HP	-	-		17
990130	Use Kit	FLT7500HP	-	-		-
990131	FLT90002	FLT7500HP	-	-		41
990132	FLT90014	FLT7500HP	-	-		17
990133	FLT90015	FLT7500HP	-	-		17
990134	Use Kit	FLT7500HP	-	-		-
990135	FLT90023	FLT7500HP	-	-		42
990136	FLT90016	FLT7500HP	-	-		41
990137	Use Kit	FLT7500HP	-	-		-
990138	Use Kit	FLT7500HP	-	-		-
990139	FLT90012	FLT7500HP	-	-		41
990140	FLT90000	FLT7500HP	-	-		41
990141	Use Kit	FLT7500HP	-	-		-
990142	FLT90005	FLT7500HP	-	-		17
990143	FLT90007	FLT7500HP	-	-		17
990144	FLT90002	FLT7500HP	-	-		41
990145	Use Kit	FLT7500HP	-	-		-
990146	Use Kit	FLT7500HP	-	-		-
990147	FLT90003	FLT7500HP	-	-		67
990148	FLT90003	FLT7500HP	-	-		67
990149	FLT90009	FLT7500HP	-	-		67
990150	Use Kit	FLT7500HP	-	-		-
990151	Use Kit	FLT7500HP	-	-		-
990152	Use Kit	FLT7500HP	-	-		-
990153	FLT90008	FLT7500HP	-	-		41
990154	Use Kit	FLT7500HP	-	-		-
990155	FLT90001	FLT7500HP	-	-		41
990156	Use Kit	FLT7500HP	-	-		-
990157	Use Kit	FLT7500HP	-	-		-
990158	Use Kit	FLT7500HP	-	-		-
990159	FLT90010	FLT7500HP	-	-		41
990160	Use Kit	FLT7500HP	-	-		-
990161	FLT90013	FLT7500HP	-	-		41
990162	FLT90018	FLT7500HP	-	-		67
990163	Use Kit	FLT7500HP	-	-		-
990164	FLT90020	FLT7500HP	-	-		67
990165	Use Kit	FLT7500HP	-	-		-
990166	Use Kit	FLT7500HP	-	-		-
990167	FLT90004	FLT7500HP	-	-		67
990169	Use Kit	FLT7500HP	-	-		-
990170	Use Kit	FLT7500HP	-	-		-
990804	FLT91010SP	FLT94207	-	-		-
990810	FLT90810	FLT94207	-	-		-
990811	FLT90810	FLT94207	-	-		-
991000	FLT91001	FLT9500HP	-	-		43
991001	FLT91000	FLT9500HP	-	-		43
991002	Use Kit	FLT9500HP	-	-		-
991003	FLT91112	FLT9500HP	-	-		49
991004	FLT91004	FLT9500HP	-	-		43
991005	FLT91006	FLT9500HP	-	-		43
991006	FLT91002	FLT9500HP	-	-		17
991007	FLT91002	FLT9500HP	-	-		17
991008	FLT91003	FLT9505SP	-	-		18
991009	FLT91005	FLT9500HP	-	-		18
991010	Use Kit	FLT9500HP	-	-		-
991011	Use Kit	FLT9500HP	-	-		-
991012	FLT91027	FLT9500HP	-	-		19
991013	FLT91001	FLT9500HP	-	-		43
991014	Use Kit	FLT9500HP	-	-		-
991015	FLT91016	FLT9500HP	-	-		43
991016	FLT91003	FLT9505SP	-	-		18
991017	FLT91027	FLT9500HP	-	-		19
991018	FLT91000	FLT9500HP	-	-		43
991019	FLT91103	FLT9500HP	-	-		48
991020	FLT91012	FLT9505SP	-	-		18
991021	FLT91007	FLT9500HP	-	-		18
991022	FLT91008	FLT9500HP	-	-		18
991023	FLT91015	FLT9500HP	-	-		18
991024	FLT91108	FLT9500HP	-	-		48
991025	FLT91000	FLT9500HP	-	-		43
991026	Use Kit	FLT9500HP	-	-		-
991027	FLT91009	FLT9500HP	-	-		43
991028	FLT91016	FLT9500HP	-	-		43

Mfr. Part #	Fleetrite On/Off	On/Off Kit	FLT 2-Speed	2-Speed Kit	Also Use	Pg. #
991029	FLT91026	FLT9500HP	-	-		44
991030	Use Kit	FLT9500HP	-	-		-
991031	Use Kit	FLT9500HP	-	-		-
991032	FLT91017	FLT9505SP	-	-		19
991033	FLT91104	FLT9500HP	-	-		48
991034	Use Kit	FLT9505SP	-	-		-
991035	Use Kit	FLT9500HP	-	-		-
991036	Use Kit	FLT9505SP	-	-		-
991037	Use Kit	FLT9500HP	-	-		-
991038	FLT91034	FLT9500HP	-	-		44
991039	FLT91018	FLT9500HP	-	-		43
991040	FLT91010	FLT9500HP	-	-		43
991041	Use Kit	FLT9505SP	-	-		-
991042	Use Kit	FLT9500HP	-	-		-
991043	Use Kit	FLT9500HP	-	-		-
991044	FLT91019	FLT9500HP	-	-		44
991045	Use Kit	FLT9500HP	-	-		-
991046	FLT91020	FLT9500HP	-	-		19
991047	Use Kit	FLT9500HP	-	-		-
991048	FLT91109	FLT9500HP	-	-		48
991049	FLT91095	FLT9500HP	-	-		47
991050	FLT91012	FLT9505SP	-	-		18
991051	FLT91011	FLT9500HP	-	-		68
991052	FLT91082	FLT9500HP	-	-		21
991053	FLT91029	FLT9500HP	-	-		44
991054	FLT91030	FLT9500HP	-	-		44
991055	FLT91022	FLT9500HP	-	-		44
991056	FLT91021	FLT9500HP	-	-		44
991057	Use Kit	FLT9500HP	-	-		-
991058	Use Kit	FLT9500HP	-	-		-
991059	Use Kit	FLT9500HP	-	-		-
991060	Use Kit	FLT9500HP	-	-		-
991061	FLT91031	FLT9500HP	-	-		68
991062	FLT91023	FLT9500HP	-	-		68
991063	FLT91036	FLT9500HP	-	-		45
991064	FLT91024	FLT9500HP	-	-		68
991065	FLT91067	FLT9500HP	-	-		20
991066	Use Kit	FLT9500HP	-	-		-
991067	FLT91027	FLT9500HP	-	-		19
991068	FLT91027	FLT9500HP	-	-		19
991069	Use Kit	FLT9500HP	-	-		-
991071	FLT91037	FLT9500HP	-	-		68
991072	Use Kit	FLT9500HP	-	-		-
991073	FLT91033	FLT9500HP	-	-		68
991074	FLT91090	FLT9500HP	-	-		22
991075	Use Kit	FLT9500HP	-	-		-
991076	FLT91014	FLT9500HP	-	-		18
991077	Use Kit	FLT9500HP	-	-		-
991078	Use Kit	FLT9500HP	-	-		-
991079	FLT91116	FLT9500HP	-	-		23
991080	Use Kit	FLT9500HP	-	-		-
991081	FLT91025	FLT9500HP	-	-		19
991082	FLT91025	FLT9500HP	-	-		19
991084	FLT91009	FLT9500HP	-	-		43
991085	FLT91032	FLT9500HP	-	-		44
991086	FLT91040	FLT9500HP	-	-		82
991087	Use Kit	FLT9500HP	-	-		-
991088	Use Kit	FLT9500HP	-	-		-
991090	FLT91028	FLT9500HP	-	-		19
991092	FLT91039	FLT9500HP	-	-		82
991093	FLT91040	FLT9500HP	-	-		82
991094	FLT91114	FLT9500HP	-	-		70
991095	Use Kit	FLT9500HP	-	-		-
991096	FLT91041	FLT9500HP	-	-		82
991098	FLT91077	FLT9500HP	-	-		69
991099	FLT91094	FLT9500HP	-	-		47
991100	FLT91039	FLT9500HP	-	-		82
991101	FLT91040	FLT9500HP	-	-		82
991102	FLT91041	FLT9500HP	-	-		82
991103	FLT91076	FLT9500HP	-	-		21
991104	Use Kit	FLT9500HP	-	-		-
991105	FLT91006	FLT9500HP	-	-		43
991106	FLT91054	FLT9500HP	-	-		45
991107	FLT91052	FLT9500HP	-	-		69
991108	FLT91038	FLT9500HP	-	-		19

Mfr. Part #	FLT On/Off	On/Off Kit	FLT 2-Speed	2-Speed Kit	Also Use	Pg. #
991109	Use Kit	FLT9500HP	-	-		-
991110	FLT91011	FLT9500HP	-	-		68
991111	FLT91000	FLT9500HP	-	-		43
991112	FLT91020	FLT9500HP	-	-		19
991113	FLT91024	FLT9500HP	-	-		68
991114	FLT91082	FLT9500HP	-	-		21
991115	Use Kit	FLT9500HP	-	-		-
991116	Use Kit	FLT9500HP	-	-		-
991117	FLT91110	FLT9500HP	-	-		48
991118	FLT91026	FLT9500HP	-	-		44
991119	FLT91014	FLT9500HP	-	-		18
991120	FLT91009	FLT9500HP	-	-		43
991121	FLT91035	FLT9500HP	-	-		19
991122	Use Kit	FLT9500HP	-	-		-
991123	FLT91000	FLT9500HP	-	-		43
991124	FLT91028	FLT9500HP	-	-		19
991125	FLT91089	FLT9500HP	-	-		22
991126	FLT91067	FLT9500HP	-	-		20
991127	FLT91024	FLT9500HP	-	-		68
991128	FLT91001	FLT9500HP	-	-		43
991129	Use Kit	FLT9500HP	-	-		-
991130	FLT91087	FLT9500HP	-	-		22
991131	FLT91090	FLT9500HP	-	-		22
991132	FLT91027	FLT9500HP	-	-		19
991133	FLT91011	FLT9500HP	-	-		68
991134	FLT91000	FLT9500HP	-	-		43
991135	FLT91001	FLT9500HP	-	-		43
991136	FLT91106	FLT9500HP	-	-		22
991137	Use Kit	FLT9500HP	-	-		-
991138	Use Kit	FLT9500HP	-	-		-
991139	Use Kit	FLT9500HP	-	-		-
991140	FLT91035	FLT9500HP	-	-		19
991142	FLT91021	FLT9500HP	-	-		44
991143	FLT91041	FLT9500HP	-	-		82
991144	FLT91040	FLT9500HP	-	-		82
991145	FLT91039	FLT9500HP	-	-		82
991146	FLT91022	FLT9500HP	-	-		44
991147	FLT91012	FLT9505SP	-	-		18
991148	FLT91007	FLT9500HP	-	-		18
991149	FLT91024	FLT9500HP	-	-		68
991150	Use Kit	FLT9500HP	-	-		-
991151	FLT91009	FLT9500HP	-	-		43
991152	FLT91014	FLT9500HP	-	-		18
991153	FLT91035	FLT9500HP	-	-		19
991154	FLT91025	FLT9500HP	-	-		19
991155	FLT91006	FLT9500HP	-	-		43
991156	FLT91018	FLT9500HP	-	-		43
991157	FLT91015	FLT9500HP	-	-		18
991158	FLT91010	FLT9500HP	-	-		43
991159	FLT91019	FLT9500HP	-	-		44
991160	FLT91029	FLT9500HP	-	-		44
991161	FLT91034	FLT9500HP	-	-		44
991162	FLT91022	FLT9500HP	-	-		44
991163	FLT91023	FLT9500HP	-	-		68
991164	FLT91076	FLT9500HP	-	-		21
991165	FLT91052	FLT9500HP	-	-		69
991166	FLT91054	FLT9500HP	-	-		45
991167	FLT91089	FLT9500HP	-	-		22
991168	FLT91032	FLT9500HP	-	-		44
991169	FLT91102	FLT9500HP	-	-		22
991170	Use Kit	FLT9500HP	-	-		-
991171	FLT91036	FLT9500HP	-	-		45
991172	Use Kit	FLT9500HP	-	-		-
991173	FLT91016	FLT9500HP	-	-		43
991174	FLT91036	FLT9500HP	-	-		45
991175	FLT91106	FLT9500HP	-	-		22
991176	FLT91012	FLT9505SP	-	-		18
991177	Use Kit	FLT9500HP	-	-		-
991178	Use Kit	FLT9500HP	-	-		-
991179	FLT91025	FLT9500HP	-	-		19
991180	FLT91094	FLT9500HP	-	-		47
991181	Use Kit	FLT9500HP	-	-		-
991182	FLT91071	FLT9500HP	-	-		21
991183	FLT91037	FLT9500HP	-	-		68
991184	FLT91068	FLT9500HP	-	-		21

Mfr. Part #	Fleetrite On/Off	On/Off Kit	FLT 2-Speed	2-Speed Kit	Also Use	Pg. #
991185	FLT91016	FLT9500HP	-	-		43
991186	FLT91110	FLT9500HP	-	-		48
991187	FLT91077	FLT9500HP	-	-		69
991188	FLT91115	FLT9505SP	-	-		22
991189	FLT91058	FLT9500HP	-	-		45
991190	Use Kit	FLT9500HP	-	-		-
991191	Use Kit	FLT9500HP	-	-		-
991192	FLT91057	FLT9500HP	-	-		20
991193	FLT91072	FLT9500HP	-	-		46
991194	Use Kit	FLT9500HP	-	-		-
991195	Use Kit	FLT9500HP	-	-		-
991196	FLT91059	FLT9500HP	-	-		20
991199	FLT91000	FLT9500HP	-	-		43
991201	FLT91060	FLT9500HP	-	-		20
991202	FLT91012	FLT9500HP	-	-		18
991203	Use Kit	FLT9500HP	-	-		-
991204	FLT91100	FLT9500HP	-	-		48
991207	FLT91061	FLT9500HP	-	-		45
991208	Use Kit	FLT9500HP	-	-		-
991209	FLT91114	FLT9500HP	-	-		70
991210	FLT91033	FLT9500HP	-	-		68
991211	FLT91085	FLT9500HP	-	-		21
991212	FLT91011	FLT9500HP	-	-		68
991213	Use Kit	FLT9500HP	-	-		-
991214	Use Kit	FLT9500HP	-	-		-
991215	Use Kit	FLT9500HP	-	-		-
991216	Use Kit	FLT9500HP	-	-		-
991217	Use Kit	FLT9500HP	-	-		-
991218	FLT91087	FLT9500HP	-	-		22
991219	Use Kit	FLT9500HP	-	-		-
991220	Use Kit	FLT9500HP	-	-		-
991221	FLT91031	FLT9500HP	-	-		68
991222	FLT91023	FLT9500HP	-	-		68
991223	FLT91011	FLT9500HP	-	-		68
991224	Use Kit	FLT9500HP	-	-		-
991225	FLT91052	FLT9500HP	-	-		69
991226	FLT91029	FLT9500HP	-	-		44
991227	FLT91019	FLT9500HP	-	-		44
991228	FLT91054	FLT9500HP	-	-		45
991229	Use Kit	FLT9500HP	-	-		-
991230	Use Kit	FLT9500HP	-	-		-
991231	FLT91038	FLT9500HP	-	-		19
991232	Use Kit	FLT9500HP	-	-		-
991233	Use Kit	FLT9500HP	-	-		-
991234	FLT91036	FLT9500HP	-	-		45
991235	FLT91009	FLT9500HP	-	-		43
991236	FLT91068	FLT9500HP	-	-		21
991237	Use Kit	FLT9500HP	-	-		-
991238	Use Kit	FLT9500HP	-	-		-
991239	Use Kit	FLT9500HP	-	-		-
991240	Use Kit	FLT9500HP	-	-		-
991241	Use Kit	FLT9500HP	-	-		-
991242	FLT91071	FLT9500HP	-	-		21
991243	FLT91026	FLT9500HP	-	-		44
991244	FLT91000	FLT9500HP	-	-		43
991245	FLT91095	FLT9500HP	-	-		47
991246	Use Kit	FLT9500HP	-	-		-
991247	FLT91082	FLT9500HP	-	-		21
991248	FLT91028	FLT9500HP	-	-		19
991249	Use Kit	FLT9500HP	-	-		-
991251	FLT91001	FLT9500HP	-	-		43
991253	Use Kit	FLT9500HP	-	-		-
991254	FLT91081	FLT9500HP	-	-		21
991255	FLT91005	FLT9500HP	-	-		18
991256	FLT91116	FLT9500HP	-	-		23
991257	Use Kit	FLT9500HP	-	-		-
991258	Use Kit	FLT9500HP	-	-		-
991259	Use Kit	FLT9500HP	-	-		-
991260	Use Kit	FLT9500HP	-	-		-
991261	FLT91055	FLT9500HP	-	-		45
991262	Use Kit	FLT9500HP	-	-		-
991263	Use Kit	FLT9500HP	-	-		-
991264	Use Kit	FLT9500HP	-	-		-
991265	FLT91056	FLT9500HP	-	-		45
991266	FLT91068	FLT9500HP	-	-		21

Mfr. Part #	FLT On/Off	On/Off Kit	FLT 2-Speed	2-Speed Kit	Also Use	Pg. #
991267	Use Kit	FLT9500HP	-	-		-
991268	FLT91001	FLT9500HP	-	-		43
991269	FLT91109	FLT9500HP	-	-		48
991270	FLT91017	FLT9505SP	-	-		19
991271	FLT91008	FLT9505SP	-	-		18
991272	FLT91112	FLT9500HP	-	-		49
991273	FLT91003	FLT9505SP	-	-		18
991274	Use Kit	FLT9505SP	-	-		-
991275	Use Kit	FLT9500HP	-	-		-
991276	FLT91129	FLT9500HP	-	-		-
991276	Use Kit	FLT9500HP	-	-		-
991277	FLT91004	FLT9500HP	-	-		43
991278	FLT91104	FLT9500HP	-	-		48
991279	FLT91103	FLT9500HP	-	-		48
991280	FLT91108	FLT9500HP	-	-		48
991281	Use Kit	FLT9500HP	-	-		-
991283	FLT91007	FLT9500HP	-	-		18
991284	FLT91081	FLT9500HP	-	-		21
991285	Use Kit	FLT9500HP	-	-		-
991286	FLT91107	FLT9500HP	-	-		70
991287	FLT91087	FLT9500HP	-	-		22
991288	FLT91088	FLT9500HP	-	-		47
991289	FLT91101	FLT9500HP	-	-		48
991290	Use Kit	FLT9500HP	-	-		-
991291	FLT91102	FLT9500HP	-	-		22
991292	FLT91095	FLT9500HP	-	-		47
991293	FLT91094	FLT9500HP	-	-		47
991294	Use Kit	FLT9500HP	-	-		-
991295	Use Kit	FLT9500HP	-	-		-
991297	FLT91020	FLT9500HP	-	-		19
991298	FLT91071	FLT9500HP	-	-		21
991299	FLT91099	FLT9500HP	-	-		47
991300	FLT91062	FLT9506HP	-	-		69
991301	Use Kit	FLT9500HP	-	-		-
991302	Use Kit	FLT9500HP	-	-		-
991303	Use Kit	FLT9500HP	-	-		-
991304	FLT91037	FLT9500HP	-	-		68
991305	FLT91066	FLT9500HP	-	-		20
991306	FLT91066	FLT9500HP	-	-		20
991307	Use Kit	FLT9500HP	-	-		-
991308	FLT91028	FLT9500HP	-	-		19
991310	FLT91058	FLT9500HP	-	-		45
991312	FLT91061	FLT9500HP	-	-		45
991316	FLT91060	FLT9500HP	-	-		20
991317	Use Kit	FLT9500HP	-	-		-
991318	Use Kit	FLT9500HP	-	-		-
991319	Use Kit	FLT9500HP	-	-		-
991320	Use Kit	FLT9500HP	-	-		-
991321	Use Kit	FLT9500HP	-	-		-
991322	Use Kit	FLT9500HP	-	-		-
991324	FLT91024	FLT9500HP	-	-		68
991325	FLT91036	FLT9500HP	-	-		45
991328	FLT91035	FLT9500HP	-	-		19
991329	FLT91009	FLT9500HP	-	-		43
991330	Use Kit	FLT9500HP	-	-		-
991331	Use Kit	FLT9500HP	-	-		-
991332	FLT91094	FLT9500HP	-	-		47
991333	FLT91033	FLT9500HP	-	-		68
991334	FLT91095	FLT9500HP	-	-		47
991335	Use Kit	FLT9500HP	-	-		-
991336	Use Kit	FLT9500HP	-	-		-
991337	Use Kit	FLT9500HP	-	-		-
991338	Use Kit	FLT9500HP	-	-		-
991339	Use Kit	FLT9500HP	-	-		-
991341	FLT91062	FLT9506HP	-	-		69
991342	Use Kit	FLT9500HP	-	-		-
991343	FLT91083	FLT9500HP	-	-		69
991345	FLT91098	FLT9500HP	-	-		22
991346	FLT91066	FLT9500HP	-	-		20
991347	FLT91072	FLT9500HP	-	-		46
991348	FLT91063	FLT9500HP	-	-		20
991349	FLT91024	FLT9500HP	-	-		68
991350	FLT91097	FLT9500HP	-	-		22
991351	FLT91096	FLT9500HP	-	-		47
991352	FLT91113	FLT9500HP	-	-		49

Cross Reference Horton-style compatible

Mfr. Part #	Fleetrite On/Off	On/Off Kit	FLT 2-Speed	2-Speed Kit	Also Use	Pg. #
991353	Use Kit	FLT9500HP	-	-	-	-
991354	Use Kit	FLT9500HP	-	-	-	-
991355	FLT91074	FLT9500HP	-	-	-	46
991356	FLT91014	FLT9500HP	-	-	-	18
991358	FLT91064	FLT9500HP	-	-	-	46
991359	Use Kit	FLT9500HP	-	-	-	-
991360	Use Kit	FLT9500HP	-	-	-	-
991361	FLT91062	FLT9506HP	-	-	-	69
991362	Use Kit	FLT9500HP	-	-	-	-
991364	FLT91001	FLT9500HP	-	-	-	43
991365	FLT91001	FLT9500HP	-	-	-	43
991366	Use Kit	FLT9500HP	-	-	-	-
991367	FLT91006	FLT9500HP	-	-	-	43
991368	FLT91006	FLT9500HP	-	-	-	43
991369	FLT91004	FLT9500HP	-	-	-	43
991370	FLT91081	FLT9500HP	-	-	-	21
991371	Use Kit	FLT9500HP	-	-	-	-
991372	FLT91014	FLT9500HP	-	-	-	18
991373	FLT91014	FLT9500HP	-	-	-	18
991374	FLT91081	FLT9500HP	-	-	-	21
991375	FLT91070	FLT9500HP	-	-	-	21
991376	FLT91069	FLT9500HP	-	-	-	21
991377	Use Kit	FLT9500HP	-	-	-	-
991378	FLT91091	FLT9500HP	-	-	-	69
991379	Use Kit	FLT9500HP	-	-	-	-
991380	Use Kit	FLT9500HP	-	-	-	-
991381	Use Kit	FLT9500HP	-	-	-	-
991382	Use Kit	FLT9500HP	-	-	-	-
991383	Use Kit	FLT9500HP	-	-	-	-
991384	Use Kit	FLT9500HP	-	-	-	-
991385	Use Kit	FLT9500HP	-	-	-	-
991386	Use Kit	FLT9500HP	-	-	-	-
991387	Use Kit	FLT9500HP	-	-	-	-
991388	Use Kit	FLT9500HP	-	-	-	-
991398	FLT91086	FLT9500HP	-	-	-	47
991399	Use Kit	FLT9500HP	-	-	-	-
993282	-	FLT3282	-	-	-	14
993283	-	FLT3283	-	-	-	14
993603	-	FLT3603	-	-	-	14
993605	-	FLT3605	-	-	-	14
993606	-	FLT3606	-	-	-	14
993607	-	FLT3607	-	-	-	14
993611	-	FLT3611	-	-	-	14
993617	-	FLT3617	-	-	-	14
993619	-	FLT3619	-	-	-	14
993653	-	FLT3653	-	-	-	14
993654	-	FLT3654	-	-	-	14
993655	-	FLT3655	-	-	-	14
994205	-	FLT4205	-	-	-	3
994207	-	FLT94207	-	-	-	-
994212	-	FLT7503	-	-	-	3
994245	-	FLT9505	-	-	-	3
994246	-	FLT9503	-	-	-	3
994305	-	FLT9500HP	-	-	-	3
994306	-	FLT9505SP	-	-	-	-
994307	-	FLT7500HP	-	-	-	3
994314	-	FLT7500HP	-	-	-	3
994315	-	FLT9500HP	-	-	-	3
994319	-	FLT9503	-	-	-	3
994321	-	FLT7503	-	-	-	3
994322	-	FLT9500HP	-	-	-	3
994323	-	FLT9500HP	-	-	-	3
994324	-	FLT7500HP	-	-	-	3
994325	-	FLT7500HP	-	-	-	3
994346	-	FLT14S	-	-	-	5
994347	-	FLT14256	-	-	-	5
994349	-	FLT14L	-	-	-	5
994353	-	FLT142561	-	-	FLT300SK	5
994356	-	FLT14200	-	-	-	5
994368	-	FLT94368	-	-	-	-
994370	-	FLT4205	-	-	-	3
994373	-	FLT14256	-	-	FLT150SK	5
994375	-	FLT14256	-	-	FLT250SK	5
994377	-	FLT14256	-	-	FLT300SK	5
994379	-	FLT14256	-	-	FLT350SK	5

Mfr. Part #	FLT On/Off	On/Off Kit	FLT 2-Speed	2-Speed Kit	Also Use	Pg. #
994381	-	FLT14256	-	-	FLT425SK	5
994383	-	FLT14200	-	-	-	5
994385	-	FLT14200	-	-	FLT150SK	5
994387	-	FLT14200	-	-	FLT300SK	5
994388	-	FLT9500HP	-	-	-	3
994389	-	FLT9500HP	-	-	-	3
994636	-	FLT24256	-	-	FLT244700	6
994900	-	FLT14256	-	-	-	5
994902	-	FLT142561	-	-	-	5
994922	-	FLT24256	-	-	FLT244700	6
994966	-	FLT14SBL	-	-	-	5
994972	-	FLT24256	-	-	FLT244700	6
994985	-	FLT14256	-	-	-	5
994995	-	FLT14256	-	-	FLT150SK	5
995031	-	FLT142561	-	-	-	5
995033	-	FLT14SBL	-	-	-	5
995034	-	FLT14256	-	-	-	5
995035	-	FLT14256	-	-	-	5
995037	-	FLT14256	-	-	FLT150SK	5
995042	-	FLT14256	-	-	FLT250SK	5
995046	-	FLT14L	-	-	-	5
995047	-	FLT14LP	-	-	-	-
995052	-	FLT14256	-	-	FLT200SK	5
995053	-	FLT14256	-	-	FLT300SK	5
995054	-	FLT14256	-	-	-	5
995055	-	FLT142561	-	-	FLT200SK	5
995056	-	FLT142561	-	-	FLT300SK	5
995057	-	FLT142561	-	-	FLT200SK	5
995058	-	FLT142561	-	-	FLT300SK	5
995062	-	FLT142561	-	-	FLT350SK	5
995063	-	FLT14256	-	-	FLT350SK	5
995509	-	FLT24256	-	-	-	6
995510	-	FLT24256	-	-	-	6
995511	-	FLT242561	-	-	-	6
995518	-	FLT24256	-	-	-	6
995519	-	FLT24256	-	-	-	6
995521	-	FLT24256	-	-	FLT244700	6
995527	-	FLT242561	-	-	-	6
995530	-	FLT14256	-	-	-	5
995534	-	FLT14256	-	-	FLT275SK	5
995543	-	see pg. 6	-	-	-	-
995547	-	see pg. 6	-	-	-	-
995557	-	FLT24256	-	-	-	6
995559	-	FLT242561	-	-	-	6
995568	-	FLT14256	-	-	-	5
995575	-	FLT14256	-	-	-	5
995582	-	FLT24256	-	-	-	6
995591	-	see pg. 6	-	-	-	-
995592	-	see pg. 6	-	-	-	-
995617	-	FLT24256	-	-	-	6
995620	-	see pg. 6	-	-	-	-
995621	-	see pg. 6	-	-	-	-
995622	-	FLT242561	-	-	-	6
995623	-	FLT24256	-	-	-	6
995624	-	FLT24256	-	-	-	6
995669	-	FLT142561	-	-	-	5
995543-250	-	see pg. 6	-	-	-	-
995543-275	-	see pg. 6	-	-	-	-
995543-300	-	see pg. 6	-	-	-	-
995543-350	-	see pg. 6	-	-	-	-
995543-400	-	see pg. 6	-	-	-	-
995543-475	-	see pg. 6	-	-	-	-
995620-200	-	see pg. 6	-	-	-	-
995620-250	-	see pg. 6	-	-	-	-
995620-275	-	see pg. 6	-	-	-	-
995620-300	-	see pg. 6	-	-	-	-
995620-350	-	see pg. 6	-	-	-	-
995620-400	-	see pg. 6	-	-	-	-
995620-475	-	see pg. 6	-	-	-	-
997001	Use Kit	FLT9500HP	-	-	-	-
997002	Use Kit	FLT9500HP	-	-	-	-
997003	Use Kit	FLT9500HP	-	-	-	-
997005	Use Kit	FLT9500HP	-	-	-	-
997006	Use Kit	FLT9500HP	-	-	-	-
997007	Use Kit	FLT9500HP	-	-	-	-

Mfr. Part #	Fleetrite On/Off	On/Off Kit	FLT 2-Speed	2-Speed Kit	Also Use	Pg. #
997008	Use Kit	FLT9500HP	-	-	-	-
997009	Use Kit	FLT9500HP	-	-	-	-
997010	Use Kit	FLT9500HP	-	-	-	-
997011	Use Kit	FLT9500HP	-	-	-	-
997012	Use Kit	FLT9500HP	-	-	-	-
997013	FLT91111	FLT9500HP	-	-	-	48
997014	FLT91092	FLT9500HP	-	-	-	47
997016	FLT91093	FLT9504HP	-	-	-	47
997017	FLT91079	FLT9500HP	-	-	-	46
997018	FLT91075	FLT9500HP	-	-	-	46
997019	FLT91105	FLT9500HP	-	-	-	69
997020	FLT91042	FLT9500HP	-	-	-	78
997021	FLT91043	FLT9500HP	-	-	-	78
997026	Use Kit	FLT9500HP	-	-	-	-
997027	FLT91078	FLT9500HP	-	-	-	46
997028	FLT91073	FLT9500HP	-	-	-	46
997029	Use Kit	FLT9500HP	-	-	-	-
997034	Use Kit	FLT9500HP	-	-	-	-
997035	FLT91084	FLT9500HP	-	-	-	86
997036	Use Kit	FLT9500HP	-	-	-	-
997037	Use Kit	FLT9500HP	-	-	-	-
997038	Use Kit	FLT9500HP	-	-	-	-
997039	FLT91037	FLT9500HP	-	-	-	68
997039	Use Kit	FLT9500HP	-	-	-	-
997040	Use Kit	FLT9500HP	-	-	-	-
997042	FLT91084	FLT9500HP	-	-	-	86
997043	Use Kit	FLT9500HP	-	-	-	-
997044	Use Kit	FLT9500HP	-	-	-	-
997045	FLT91073	FLT9500HP	-	-	-	46
997046	Use Kit	FLT9500HP	-	-	-	-
997047	FLT91044	FLT9500HP	-	-	-	45
997048	FLT91045	FLT9500HP	-	-	-	45
997049	Use Kit	FLT9500HP	-	-	-	-
997050	Use Kit	FLT9500HP	-	-	-	-
997051	Use Kit	FLT9500HP	-	-	-	-
997052	Use Kit	FLT9500HP	-	-	-	-
997053	FLT91080	FLT9500HP	-	-	-	46
997054	Use Kit	FLT9500HP	-	-	-	-
997055	Use Kit	FLT9500HP	-	-	-	-
997056	Use Kit	FLT9500HP	-	-	-	-
997057	Use Kit	FLT9500HP	-	-	-	-
997058	Use Kit	FLT9500HP	-	-	-	-
997059	Use Kit	FLT9500HP	-	-	-	-
997060	Use Kit	FLT9500HP	-	-	-	-
997061	Use Kit	FLT9500HP	-	-	-	-
997062	Use Kit	FLT9500HP	-	-	-	-
997063	Use Kit	FLT9500HP	-	-	-	-
997064	FLT91046	FLT9500HP	-	-	-	68
997065	FLT91047	FLT9500HP	-	-	-	68
997066	Use Kit	FLT9500HP	-	-	-	-
997067	Use Kit	FLT9500HP	-	-	-	-
997068	FLT91048	FLT9500HP	-	-	-	19
997069	FLT91049	FLT9500HP	-	-	-	20
997070	Use Kit	FLT9500HP	-	-	-	-
997071	Use Kit	FLT9500HP	-	-	-	-
997072	FLT91050	FLT9500HP	-	-	-	69
997073	Use Kit	FLT9500HP	-	-	-	-
997074	FLT91075	FLT9500HP	-	-	-	46
997075	FLT91079	FLT9500HP	-	-	-	46
997076	Use Kit	FLT9500HP	-	-	-	-
997077	FLT91051	FLT9500HP	-	-	-	20
997078	FLT91116	FLT9500HP	-	-	-	23
997079	Use Kit	FLT9500HP	-	-	-	-
997080	Use Kit	FLT9500HP	-	-	-	-
997083	FLT91091	FLT9500HP	-	-	-	69
997084	Use Kit	FLT9500HP	-	-	-	-
997085	Use Kit	FLT9500HP	-	-	-	-
997086	Use Kit	FLT9500HP	-	-	-	-
997087	FLT91066	FLT9500HP	-	-	-	20
997088	FLT91070	FLT9500HP	-	-	-	21
997089	FLT91069	FLT9500HP	-	-	-	21
997091	FLT91080	FLT9500HP	-	-	-	46
997092	Use Kit	FLT9500HP	-	-	-	-
997094	Use Kit	FLT9500HP	-	-	-	-
997095	FLT91088	FLT9500HP	-	-	-	47

Mfr. Part #	FLT On/Off	On/Off Kit	FLT 2-Speed	2-Speed Kit	Also Use	Pg. #
997096	FLT91097	FLT9500HP	-	-	-	22
997098	Use Kit	FLT9500HP	-	-	-	-
998001	FLT228005	-	-	-	-	-
998002	FLT228006	-	-	-	-	-
998003	FLT228005	-	-	-	-	-
998004	FLT228006	-	-	-	-	-
998005	FLT228005	-	-	-	-	-
998006	FLT228006	-	-	-	-	-
998162	-	-	FLT996272	FLT242561	-	-
998600	FLT98600	FLT14256	FLT986002	FLT24256	-	49
998601	FLT98601	FLT14256	FLT986012	FLT24256	-	49
998602	FLT99860	FLT14256	FLT998602	FLT24256	-	-
998603	FLT98603	FLT14256	FLT986032	FLT24256	-	-
998604	FLT98604	FLT14256	FLT986042	FLT24256	-	-
998605	FLT99410	FLT14256	FLT994102	FLT24256	-	76
998606	-	-	FLT986062	FLT24256	-	-
998607	FLT98607	FLT14256	FLT986072	FLT24256	-	78
998608	FLT98608	FLT14256	FLT986082	FLT24256	-	-
998609	FLT98609	FLT14256	FLT986092	FLT24256	-	-
998610	FLT99160	FLT14256	FLT991602	FLT24256	-	27
998611	FLT98611	FLT14256	FLT986112	FLT24256	-	-
998612	-	-	FLT986122	FLT24256	-	-
998613	FLT98613	FLT14256	FLT986132	FLT24256	-	-
998614	FLT98614	FLT14256	FLT986142	FLT24256	-	23
998615	FLT98615	FLT14256	FLT986152	FLT24256	-	70
998616	FLT98616	FLT14256	FLT986162	FLT24256	-	-
998617	FLT98617	FLT14256	FLT986172	FLT24256	-	-
998618	FLT98618	FLT14256	FLT986182	FLT24256	-	-
998620	FLT98620	FLT14256	FLT986202	FLT24256	-	70
998621	FLT98621	FLT14256	FLT986212	FLT24256	-	70
998622	FLT98622	FLT14256	FLT986222	FLT24256	-	-
998623	FLT99883	FLT142561	FLT998832	FLT242561	-	-
998624	FLT98624	FLT14256	FLT986242	FLT24256	FLT300SK	-
998625	FLT99884	FLT14256	FLT998842	FLT24256	-	-
998627	FLT98627	FLT14256	FLT986272	FLT24256	-	85
998629	FLT98629	FLT14256	FLT986292	FLT24256	-	-
998630	FLT98630	FLT14256	FLT986302	FLT24256	-	83
998631	FLT98631	FLT14256	FLT986312	FLT24256	-	85
998632	FLT98632	FLT142561	FLT986322	FLT242561	-	85
998633	FLT98633	FLT14256	FLT986332	FLT24256	-	-
998639	FLT99352	FLT14256	FLT993522	FLT24256	-	62
998640	FLT99254	FLT14256	FLT992542	FLT24256	-	-
998641	FLT98641	FLT14256	FLT986412	FLT24256	-	23
998644	FLT99514	FLT14256	FLT995142	FLT24256	-	-
998645	FLT98645	FLT142561	FLT986452	FLT242561	-	23
999xxx						
999001	FLT99001	FLT14256	FLT990012	FLT24256	-	70
999002	FLT99002	FLT14200	FLT990022	FLT24-200	Remove Studs	49
999003	FLT99003	FLT14200	FLT990032	FLT24-200	Remove Studs	71
999004	FLT99004	FLT14256	FLT990042	FLT24256	-	49
999005	FLT99005	FLT14256	FLT990052	FLT24256	-	49
999006	FLT99006	FLT14200	FLT990062	FLT24-200	-	71
999007	FLT99007	FLT14256	FLT990072	FLT24256	-	71
999008	FLT99008	FLT142561	FLT990082	FLT242561	-	23
999009	FLT99009	FLT142561	FLT990092	FLT242561	-	23
999010	FLT99010	FLT142561	FLT990102	FLT242561	-	49
999011	FLT99011	FLT142561	FLT990112	FLT242561	-	50
999012	FLT99012	FLT14256	FLT990122	FLT24256	-	23
999013	FLT99013	FLT14256	FLT990132	FLT24256	-	-
999014	FLT99014	FLT14256	FLT990142	FLT24256	-	50
999015	FLT99015	FLT14256	FLT990152	FLT24256	-	50
999016	FLT99016	FLT14256	FLT990162	FLT24256	-	71
999017	FLT99017	FLT14256	FLT990172	FLT24256	-	71
999018	FLT99018	FLT14256	FLT990182	FLT24256	-	71
999019	FLT99019	FLT14256	FLT990192	FLT24256	-	86
999020	FLT99090	FLT14256	FLT990902	FLT24256	-	53
999023	FLT99023	FLT14256	FLT990232	FLT24256	-	78
999024	FLT99024	FLT14256	FLT990242	FLT24256	-	78
999025	FLT99025	FLT14200	FLT990252	FLT24-200	Remove Studs	50
999026	FLT99026	FLT14256	FLT990262	FLT24256	-	50
999027	FLT99027	FLT14256	FLT990272	FLT24256	FLT250SK	71
999028	FLT99028	FLT14256	FLT990282	FLT24256	-	71
999029	FLT99029	FLT14256	FLT990292	FLT24256	-	72
999030	FLT99030	FLT142561	FLT990302	FLT242561	-	50
999031	FLT99031	FLT14256	FLT990312	FLT24256	FLT250SK	72

Cross Reference Horton-style compatible

Mfr. Part #	Fleetrite On/Off	On/Off Kit	FLT 2-Speed	2-Speed Kit	Also Use	Pg. #
999034	FLT99034	FLT14256	FLT990342	FLT24256		24
999035	FLT99035	FLT14256	FLT990352	FLT24256		50
999036	FLT99036	FLT14256	FLT990362	FLT24256		50
999037	FLT99037	FLT14256	FLT990372	FLT24256		24
999038	FLT99038	FLT14256	FLT990382	FLT24256		24
999039	FLT99039	FLT14256	FLT990392	FLT24256		-
999040	FLT99040	FLT14256	FLT990402	FLT24256		-
999041	FLT99041	FLT14256	FLT990412	FLT24256		72
999043	FLT99043	FLT14256	FLT990432	FLT24256		-
999044	FLT99044	FLT14256	FLT990442	FLT24256		24
999045	FLT99045	FLT14256	FLT990452	FLT24256		51
999046	FLT99046	FLT14256	FLT990462	FLT24256		24
999047	FLT99047	FLT14256	FLT990472	FLT24256		53
999048	FLT99048	FLT14256	FLT990482	FLT24256		51
999049	FLT99049	FLT14256	FLT990492	FLT24256		72
999050	FLT99050	FLT14256	FLT990502	FLT24256		51
999051	FLT99051	FLT14256	FLT990512	FLT24256		51
999052	FLT99052	FLT14256	FLT990522	FLT24256		51
999053	FLT99053	FLT14256	FLT990532	FLT24256		51
999054	FLT99054	FLT14256	FLT990542	FLT24256		51
999055	FLT99055	FLT14256	FLT990552	FLT24256		51
999056	FLT99056	FLT14256	FLT990562	FLT24256		52
999057	FLT99057	FLT14256	FLT990572	FLT24256		52
999058	FLT99058	FLT14256	FLT990582	FLT24256		52
999059	FLT99059	FLT14256	FLT990592	FLT24256		52
999060	FLT99060	FLT14256	FLT990602	FLT24256		52
999061	FLT99061	FLT14256	FLT990612	FLT24256		72
999062	FLT99062	FLT14256	FLT990622	FLT24256		72
999063	FLT99063	FLT14256	FLT990632	FLT24256		72
999064	FLT99064	FLT14256	FLT990642	FLT24256		72
999065	FLT99065	FLT14256	FLT990652	FLT24256		73
999066	FLT99066	FLT14256	FLT990662	FLT24256		73
999067	FLT99067	FLT14256	FLT990672	FLT24256		-
999068	FLT99068	FLT14256	FLT990682	FLT24256		24
999069	FLT99069	FLT14256	FLT990692	FLT24256		24
999070	FLT99070	FLT14256	FLT990702	FLT24256		24
999071	FLT99071	FLT14256	FLT990712	FLT24256		30
999072	FLT99072	FLT14256	FLT990722	FLT24256		25
999073	FLT99073	FLT14256	FLT990732	FLT24256		25
999074	FLT99074	FLT14256	FLT990742	FLT24256		25
999075	FLT99075	FLT14256	FLT990752	FLT24256		25
999076	FLT99076	FLT14256	FLT990762	FLT24256		25
999077	FLT99077	FLT142561	FLT990772	FLT242561		83
999078	FLT99078	FLT14256	FLT990782	FLT24256		25
999079	FLT99079	FLT14256	FLT990792	FLT24256		25
999080	FLT99080	FLT14256	FLT990802	FLT24256		25
999081	FLT99081	FLT14256	FLT990812	FLT24256		52
999082	FLT99082	FLT14256	FLT990822	FLT24256		52
999083	FLT99083	FLT14256	FLT990832	FLT24256		-
999084	FLT99084	FLT14256	FLT990842	FLT24256		26
999085	FLT99085	FLT14256	FLT990852	FLT24256		73
999087	FLT99087	FLT14256	FLT990872	FLT24256		-
999088	FLT99088	FLT14256	FLT990882	FLT24256		52
999090	FLT99090	FLT14256	FLT990902	FLT24256		53
999091	FLT99091	FLT14256	FLT990912	FLT24256		-
999092	FLT99092	FLT14256	FLT990922	FLT24256		73
999093	FLT99093	FLT14256	FLT990932	FLT24256		73
999094	FLT99094	FLT14256	FLT990942	FLT24256		53
999095	FLT99095	FLT14256	FLT990952	FLT24256		53
999096	FLT99096	FLT14256	FLT990962	FLT24256		52
999097	FLT99097	FLT14256	FLT990972	FLT24256		53
999098	FLT99098	FLT14256	FLT990982	FLT24256		26
999099	FLT99099	FLT14256	FLT990992	FLT24256		53
999100	FLT99100	FLT14256	FLT991002	FLT24256		-
999101	FLT99101	FLT14256	FLT991012	FLT24256		53
999102	FLT99102	FLT14256	FLT991022	FLT24256		-
999103	FLT99103	FLT14256	FLT991032	FLT24256		26
999104	FLT99104	FLT14256	FLT991042	FLT24256		53
999106	FLT99106	FLT14256	FLT991062	FLT24256		-
999107	FLT99107	FLT14256	FLT991072	FLT24256		-
999108	FLT99108	FLT14256	FLT991082	FLT24256		53
999110	FLT99110	FLT14256	FLT991102	FLT24256	FLT350SK	54
999111	FLT99111	FLT14256	FLT991112	FLT24256		54
999112	FLT99112	FLT14256	FLT991122	FLT24256		54
999113	FLT99113	FLT14256	FLT991132	FLT24256		54

Mfr. Part #	FLT On/Off	On/Off Kit	FLT 2-Speed	2-Speed Kit	Also Use	Pg. #
999114	FLT99114	FLT14256	FLT991142	FLT24256		54
999115	FLT99115	FLT14256	FLT991152	FLT24256		54
999116	FLT99116	FLT14256	FLT991162	FLT24256	FLT250SK	54
999117	FLT99117	FLT14256	FLT991172	FLT24256		54
999118	FLT99118	FLT14256	FLT991182	FLT24256		55
999119	FLT99119	FLT14256	FLT991192	FLT24256		26
999124	FLT99124	FLT14256	FLT991242	FLT24256		55
999125	FLT99125	FLT142561	FLT991252	FLT242561		55
999126	FLT99126	FLT14256	FLT991262	FLT24256		55
999127	FLT99127	FLT14256	FLT991272	FLT24256		55
999128	FLT99128	FLT14256	FLT991282	FLT24256		55
999129	FLT99129	FLT14256	FLT991292	FLT24256		55
999130	FLT99130	FLT14256	FLT991302	FLT24256		55
999131	FLT99131	FLT14256	FLT991312	FLT24256		56
999132	FLT99132	FLT14256	FLT991322	FLT24256		56
999133	FLT99133	FLT14256	FLT991332	FLT24256		56
999134	FLT99134	FLT14256	FLT991342	FLT24256		56
999135	FLT99135	FLT14256	FLT991352	FLT24256		26
999136	FLT99136	FLT14256	FLT991362	FLT24256		-
999139	FLT99139	FLT14256	FLT991392	FLT24256		26
999142	FLT99142	FLT142561	FLT991422	FLT242561		83
999143	FLT99143	FLT142561	FLT991432	FLT242561		83
999146	FLT99146	FLT14256	FLT991462	FLT24256		73
999147	FLT99147	FLT14256	FLT991472	FLT24256	FLT425SK	-
999149	FLT99149	FLT14256	FLT991492	FLT24256	FLT200SK	-
999150	FLT99150	FLT14256	FLT991502	FLT24256		56
999151	FLT99151	FLT14256	FLT991512	FLT24256	FLT200SK	73
999152	FLT99152	FLT14256	FLT991522	FLT24256		-
999153	FLT99153	FLT14200	FLT991532	FLT24-200		56
999154	FLT99154	FLT14256	FLT991542	FLT24256		56
999155	FLT99155	FLT14256	FLT991552	FLT24256		26
999157	FLT99157	FLT14256	FLT991572	FLT24256		26
999158	FLT99158	FLT14200	FLT991582	FLT24-200		-
999159	FLT99159	FLT14256	FLT991592	FLT24256		-
999160	FLT99160	FLT14256	FLT991602	FLT24256		27
999161	FLT99161	FLT14256	FLT991612	FLT24256		27
999162	FLT99162	FLT14256	FLT991622	FLT24256		27
999163	FLT99163	FLT14256	FLT991632	FLT24256		27
999164	FLT99164	FLT14256	FLT991642	FLT24256		27
999165	FLT99165	FLT14256	FLT991652	FLT24256		27
999166	FLT99166	FLT14256	FLT991662	FLT24256		-
999167	FLT99167	FLT14256	FLT991672	FLT24256		56
999168	FLT99168	FLT14256	FLT991682	FLT24256		57
999169	FLT99169	FLT14256	FLT991692	FLT24256		57
999170	FLT99170	FLT14256	FLT991702	FLT24256	FLT250SK	57
999171	FLT99171	FLT14256	FLT991712	FLT24256		57
999172	FLT99172	FLT14256	FLT991722	FLT24256	FLT200SK	57
999173	FLT99173	FLT14256	FLT991732	FLT24256		27
999174	FLT99174	FLT14256	FLT991742	FLT24256		57
999175	FLT99175	FLT14256	FLT991752	FLT24256		57
999176	FLT99176	FLT14256	FLT991762	FLT24256	FLT250SK	-
999177	FLT99177	FLT14256	FLT991772	FLT24256		27
999181	FLT99181	FLT14200	FLT991812	FLT24-200	FLT300SK	-
999183	FLT99183	FLT14256	FLT991832	FLT24256		35
999184	FLT99184	FLT14256	FLT991842	FLT24256		36
999186	FLT99186	FLT14256	FLT991862	FLT24256	FLT244700	-
999187	FLT99187	FLT14256	FLT991872	FLT24256		-
999188	FLT99188	FLT14256	FLT991882	FLT24256		57
999189	FLT99189	FLT14256	FLT991892	FLT24256		27
999190	FLT99190	FLT14256	FLT991902	FLT24256		28
999191	FLT99191	FLT14256	FLT991912	FLT24256	FLT300SK	28
999192	FLT99192	FLT14256	FLT991922	FLT24256		27
999194	FLT99194	FLT14256	FLT991942	FLT24256		28
999195	FLT99195	FLT14256	FLT991952	FLT24256		63
999196	FLT99196	FLT14256	FLT991962	FLT24256		86
999197	FLT99197	FLT14256	FLT991972	FLT24256		86
999198	FLT99198	FLT14256	FLT991982	FLT24256		58
999199	FLT99199	FLT14256	FLT991992	FLT24256		28
999200	FLT99200	FLT14256	FLT992002	FLT24256		28
999201	FLT99201	FLT14200	FLT992012	FLT24-200	FLT200SK	58
999202	FLT99202	FLT14256	FLT992022	FLT24256		-
999203	FLT99203	FLT14256	FLT992032	FLT24256		74
999204	FLT99204	FLT14256	FLT992042	FLT24256		74
999205	FLT99205	FLT14256	FLT992052	FLT24256		58
999206	FLT99206	FLT14256	FLT992062	FLT24256		-

Mfr. Part #	Fleetrite On/Off	On/Off Kit	FLT 2-Speed	2-Speed Kit	Also Use	Pg. #
999207	FLT99207	FLT14256	FLT992072	FLT24256		58
999208	FLT99208	FLT14256	FLT992082	FLT24256		28
999209	FLT99209	FLT14256	FLT992092	FLT24256		28
999211	FLT99211	FLT14256	FLT992112	FLT24256		28
999212	FLT99212	FLT14256	FLT992122	FLT24256		29
999213	FLT99213	FLT14256	FLT992132	FLT24256		-
999214	FLT99214	FLT14256	FLT992142	FLT24256		-
999216	FLT99216	FLT14256	FLT992162	FLT24256	FLT250SK	74
999217	FLT99217	FLT14256	FLT992172	FLT24256		74
999218	FLT99218	FLT14256	FLT992182	FLT24256	FLT250SK	58
999219	FLT99219	FLT14256	FLT992192	FLT24256	FLT250SK	58
999220	FLT99220	FLT14256	FLT992202	FLT24256		29
999221	FLT99221	FLT14256	FLT992212	FLT24256		29
999222	FLT99222	FLT14256	FLT992222	FLT24256		74
999223	FLT99223	FLT14256	FLT992232	FLT24256		74
999224	FLT99224	FLT14256	FLT992242	FLT24256		74
999225	FLT99225	FLT14256	FLT992252	FLT24256		74
999226	FLT99226	FLT14256	FLT992262	FLT24256		75
999227	FLT99065	FLT14256	FLT990652	FLT24256		73
999228	FLT99228	FLT14256	FLT992282	FLT24256		75
999229	FLT99229	FLT14256	FLT992292	FLT24256	FLT250SK	75
999230	FLT99230	FLT14256	FLT992302	FLT24256		-
999231	FLT99231	FLT14256	FLT992312	FLT24256		-
999232	FLT99232	FLT14256	FLT992322	FLT24256		58
999233	FLT99233	FLT142561	FLT992332	FLT242561		58
999235	FLT99235	FLT14256	FLT992352	FLT24256	FLT244700	-
999236	FLT99236	FLT14256	FLT992362	FLT24256	FLT244700	-
999238	FLT99238	FLT14256	FLT992382	FLT24256		59
999239	FLT99877	FLT14256	FLT998772	FLT24256		-
999240	FLT99240	FLT14256	FLT992402	FLT24256		29
999241	FLT99241	FLT14256	FLT992412	FLT24256		29
999242	FLT99242	FLT14256	FLT992422	FLT24256		59
999243	FLT99243	FLT14256	FLT992432	FLT24256		75
999246	FLT99246	FLT14256	FLT992462	FLT24256		59
999247	FLT99247	FLT14256	FLT992472	FLT24256		80
999248	FLT99248	FLT142561	FLT992482	FLT242561		59
999251	FLT99251	FLT142561	FLT992512	FLT242561		83
999252	FLT99252	FLT14256	FLT992522	FLT24256		78
999253	FLT99253	FLT14256	FLT992532	FLT24256	FLT350SK	59
999254	FLT99254	FLT14256	FLT992542	FLT24256		-
999255	FLT99255	FLT14256	FLT992552	FLT24256		75
999256	FLT99256	FLT14256	FLT992562	FLT24256	FLT300SK	75
999259	FLT99259	FLT142561	FLT992592	FLT242561		59
999261	FLT99261	FLT14256	FLT992612	FLT24256		-
999262	FLT99262	FLT14256	FLT992622	FLT24256		-
999263	FLT99263	FLT14256	FLT992632	FLT24256		59
999264	FLT99264	FLT14256	FLT992642	FLT24256		59
999266	FLT99266	FLT14256	FLT992662	FLT24256		-
999268	FLT99268	FLT14256	FLT992682	FLT24256		75
999269	FLT99269	FLT14256	FLT992692	FLT24256		29
999270	FLT99270	FLT14256	FLT992702	FLT24256		-
999272	FLT99272	FLT14256	FLT992722	FLT24256		76
999273	FLT99273	FLT14256	FLT992732	FLT24256		29
999274	FLT99274	FLT14256	FLT992742	FLT24256	FLT244700 + FLT250SK	-
999275	FLT99275	FLT142561	FLT992752	FLT242561		83
999277	FLT99277	FLT14256	FLT992772	FLT24256		60
999278	FLT99278	FLT14256	FLT992782	FLT24256		60
999279	FLT99279	FLT14256	FLT992792	FLT24256		29
999280	FLT99387	FLT14256	FLT993872	FLT24256		34
999281	FLT99387	FLT14256	FLT993872	FLT24256		34
999282	FLT99282	FLT142561	FLT992822	FLT242561	FLT200SK	60
999283	FLT99283	FLT14256	FLT992832	FLT24256	FLT200SK	60
999285	FLT99285	FLT14256	FLT992852	FLT24256		75
999286	FLT99286	FLT14200	FLT992862	FLT24256	FLT300SK	-
999289	FLT99289	FLT14256	FLT992892	FLT24256	FLT300SK	30
999291	FLT99291	FLT14256	FLT992912	FLT24256	FLT300SK	30
999292	FLT99070	FLT14256	FLT990702	FLT24256		24
999293	FLT99293	FLT14256	FLT992932	FLT24256		30
999294	FLT99078	FLT14256	FLT990782	FLT24256		25
999295	FLT99295	FLT14256	FLT992952	FLT24256		60
999296	FLT99296	FLT14256	FLT992962	FLT24256	FLT350SK	60
999297	FLT99297	FLT14256	FLT992972	FLT24256		60
999298	FLT99298	FLT14256	FLT992982	FLT24256		30
999300	FLT99300	FLT14256	FLT993002	FLT24256		76

Mfr. Part #	FLT On/Off	On/Off Kit	FLT 2-Speed	2-Speed Kit	Also Use	Pg. #
999301	FLT99301	FLT142561	FLT993012	FLT242561		83
999302	FLT99302	FLT142561	FLT993022	FLT242561		84
999303	FLT99303	FLT14256	FLT993032	FLT24256		-
999304	FLT99304	FLT14200	FLT993042	FLT24-200		76
999305	FLT99305	FLT14200	FLT993052	FLT24-200		76
999306	FLT99306	FLT14256	FLT993062	FLT24256		60
999307	FLT99307	FLT14256	FLT993072	FLT24256		30
999309	FLT99309	FLT14256	FLT993092	FLT24256		61
999310	FLT99310	FLT142561	FLT993102	FLT242561		61
999311	FLT99311	FLT142561	FLT993112	FLT242561		30
999313	FLT99313	FLT14256	FLT993132	FLT24256		31
999316	FLT99316	FLT14256	FLT993162	FLT24256		31
999317	FLT99317	FLT14256	FLT993172	FLT24256		31
999318	FLT99318	FLT14256	FLT993182	FLT24256		31
999319	FLT99319	FLT14256	FLT993192	FLT24256		31
999320	FLT99319	FLT14256	FLT993192	FLT24256		31
999321	FLT99321	FLT14256	FLT993212	FLT24256		-
999322	FLT99322	FLT14256	FLT993222	FLT24256		31
999323	FLT99298	FLT14256	FLT992982	FLT24256		30
999324	FLT99324	FLT14256	FLT993242	FLT24256		61
999325	FLT99325	FLT14256	FLT993252	FLT24256	FLT250SK	61
999326	FLT99326	FLT14256	FLT993262	FLT24256	FLT250SK	61
999327	FLT99327	FLT14256	FLT993272	FLT24256		31
999329	FLT99329	FLT14256	FLT993292	FLT24256		-
999330	FLT99330	FLT14256	FLT993302	FLT24256		31
999331	FLT99331	FLT14256	FLT993312	FLT24256		61
999332	FLT99332	FLT14256	FLT993322	FLT24256	FLT250SK	-
999333	FLT99333	FLT14256	FLT993332	FLT24256		32
999334	FLT99334	FLT14256	FLT993342	FLT24256		32
999335	FLT99335	FLT14256	FLT993352	FLT24256		-
999336	FLT99336	FLT142561	FLT993362	FLT242561		84
999337	FLT99337	FLT14256	FLT993372	FLT24256		32
999339	FLT99339	FLT142561	FLT993392	FLT242561		32
999340	FLT99361	FLT14256	FLT993612	FLT24256		33
999341	FLT99341	FLT142561	FLT993412	FLT242561		32
999342	FLT99298	FLT14256	FLT992982	FLT24256		30
999343	FLT99343	FLT14256	FLT993432	FLT24256		61
999346	FLT99346	FLT14256	FLT993462	FLT24256		32
999347	FLT99494	FLT14256	FLT994942	FLT24256		80
999348	FLT99495	FLT14256	FLT994952	FLT24256		80
999349	FLT99349	FLT14256	FLT993492	FLT24256		61
999350	FLT99350	FLT14256	FLT993502	FLT24256		62
999351	FLT99351	FLT14256	FLT993512	FLT24256		32
999352	FLT99352	FLT14256	FLT993522	FLT24256		62
999353	FLT99353	FLT142561	FLT993532	FLT242561		32
999354	FLT99354	FLT14256	FLT993542	FLT24256		33
999356	FLT99499	FLT14256	FLT994992	FLT24256	FLT250SK	81
999357	FLT99498	FLT14256	FLT994982	FLT24256	FLT250SK	81
999358	FLT99358	FLT142561	FLT993582	FLT242561		33
999359	FLT99359	FLT142561	FLT993592	FLT242561		33
999360	FLT99360	FLT14256	FLT993602	FLT24256		33
999361	FLT99361	FLT14256	FLT993612	FLT24256		33
999362	FLT99362	FLT14256	FLT993622	FLT24256		33
999363	FLT99363	FLT142561	FLT993632	FLT242561		33
999364	FLT99364	FLT14256	FLT993642	FLT24256		-
999365	FLT99365	FLT14256	FLT993652	FLT24256		62
999366	FLT99366	FLT14256	FLT993662	FLT24256		33
999367	FLT99367	FLT142561	FLT993672	FLT242561		34
999368	FLT99368	FLT142561	FLT993682	FLT242561		34
999369	FLT99369	FLT14256	FLT993692	FLT24256		34
999372	FLT99466	FLT14256	FLT994662	FLT24256		63
999373	FLT99465	FLT14256	FLT994652	FLT24256		86
999374	FLT99374	FLT14256	FLT993742	FLT24256		34
999375	FLT99375	FLT14256	FLT993752	FLT24256		-
999377	FLT99377	FLT14256	FLT993772	FLT24256		34
999378	FLT99378	FLT14256	FLT993782	FLT24256		-
999380	FLT99380	FLT14256	FLT993802	FLT24256		-
999381	FLT99381	FLT14256	FLT993812	FLT24256		84
999382	FLT99382	FLT14256	FLT993822	FLT24256		34
999383	FLT99383	FLT14256	FLT993832	FLT24256		-
999384	FLT99384	FLT14256	FLT993842	FLT24256		62
999385	FLT99385	FLT14256	FLT993852	FLT24256		-
999386	FLT99386	FLT14256	FLT993862	FLT24256		34
999387	FLT99387	FLT14256	FLT993872	FLT24256		34
999388	FLT99388	FLT14256	FLT993882	FLT24256		-

Cross Reference Horton-style compatible

Mfr. Part #	Fleetrite On/Off	On/Off Kit	FLT 2-Speed	2-Speed Kit	Also Use	Pg. #
999389	FLT99389	FLT14256	FLT99389	FLT24256	FLT250SK	62
999395	FLT99190	FLT14256	FLT99190	FLT24256		28
999396	FLT99191	FLT14256	FLT99191	FLT24256	FLT300SK	28
999398	FLT99398	FLT14256	FLT99398	FLT24256		-
999399	FLT99399	FLT14256	FLT99399	FLT24256		80
999400	FLT99492	FLT14256	FLT99492	FLT24256		80
999401	FLT99401	FLT14256	FLT99401	FLT24256		35
999402	FLT99402	FLT14256	FLT99402	FLT24256		-
999403	FLT99403	FLT14256	FLT99403	FLT24256		35
999404	FLT99404	FLT14256	FLT99404	FLT24256		-
999405	FLT99405	FLT14256	FLT99405	FLT24256		35
999406	FLT99406	FLT14256	FLT99406	FLT24256		-
999407	FLT99407	FLT14256	FLT99407	FLT24256		80
999409	FLT99409	FLT14256	FLT99409	FLT24256		-
999410	FLT99410	FLT14256	FLT99410	FLT24256		76
999411	FLT99411	FLT142561	FLT99411	FLT242561		35
999412	FLT99412	FLT14256	FLT99412	FLT24256		35
999413	FLT99412	FLT14256	FLT99412	FLT24256		35
999414	FLT99411	FLT142561	FLT99411	FLT242561		35
999415	FLT99415	FLT14256	FLT99415	FLT24256		62
999416	FLT99416	FLT14256	FLT99416	FLT24256	FLT300SK	-
999417	FLT99417	FLT14256	FLT99417	FLT24256		-
999418	FLT99418	FLT14256	FLT99418	FLT24256		-
999419	FLT99419	FLT14200	FLT99419	FLT24-200	FLT200SK	76
999420	FLT99420	FLT14256	FLT99420	FLT24256		35
999421	FLT99421	FLT14256	FLT99421	FLT24256		35
999422	FLT99422	FLT14256	FLT99422	FLT24256		35
999423	FLT99423	FLT14256	FLT99423	FLT24256		80
999424	FLT99202	FLT14256	FLT99202	FLT24256		-
999425	FLT99387	FLT14256	FLT99387	FLT24256		34
999426	FLT99499	FLT14256	FLT99499	FLT24256		81
999427	FLT99498	FLT14256	FLT99498	FLT24256		81
999428	FLT99428	FLT14256	FLT99428	FLT24256		36
999429	FLT99429	FLT14256	FLT99429	FLT24256		76
999430	FLT99430	FLT14256	FLT99430	FLT24256		62
999431	FLT99431	FLT14256	FLT99431	FLT24256		-
999434	FLT99434	FLT14256	FLT99434	FLT24256		-
999435	FLT99387	FLT14256	FLT99387	FLT24256		34
999436	FLT99279	FLT14256	FLT99279	FLT24256		29
999437	FLT99346	FLT14256	FLT99346	FLT24256		32
999438	FLT99438	FLT14256	FLT99438	FLT24256		36
999439	FLT99387	FLT14256	FLT99387	FLT24256		34
999440	FLT99440	FLT14256	FLT99440	FLT24256		36
999444	FLT99444	FLT14256	FLT99444	FLT24256	FLT200SK	-
999445	FLT99445	FLT14256	FLT99445	FLT24256		36
999446	FLT99446	FLT14256	FLT99446	FLT24256		62
999448	FLT99448	FLT14256	FLT99448	FLT24256		-
999450	FLT99450	FLT14256	FLT99450	FLT24256	FLT200SK	76
999451	FLT99451	FLT14256	FLT99451	FLT24256		-
999452	FLT99452	FLT14256	FLT99452	FLT24256		-
999453	FLT99453	FLT142561	FLT99453	FLT242561		36
999454	FLT99454	FLT14256	FLT99454	FLT24256		86
999455	FLT99455	FLT142561	FLT99455	FLT242561		84
999457	FLT99457	FLT14256	FLT99457	FLT24256		36
999458	FLT99458	FLT14256	FLT99458	FLT24256		36
999459	FLT99459	FLT14256	FLT99459	FLT24256	FLT200SK	76
999461	FLT99461	FLT14256	FLT99461	FLT24256		-
999463	FLT99196	FLT14256	FLT99196	FLT24256		86
999465	FLT99465	FLT14256	FLT99465	FLT24256		86
999466	FLT99466	FLT14256	FLT99466	FLT24256		63
999467	FLT99380	FLT14256	FLT99380	FLT24256		-
999468	FLT99431	FLT14256	FLT99431	FLT24256		-
999469	FLT99469	FLT14256	FLT99469	FLT24256		-
999470	FLT99247	FLT14256	FLT99247	FLT24256		80
999471	FLT99492	FLT14256	FLT99492	FLT24256		80
999472	FLT99493	FLT14256	FLT99493	FLT24256		80
999473	FLT99494	FLT14256	FLT99494	FLT24256		80
999474	FLT99495	FLT14256	FLT99495	FLT24256		80
999475	FLT99423	FLT14256	FLT99423	FLT24256		80
999476	FLT99497	FLT14256	FLT99497	FLT24256		81
999477	FLT99498	FLT14256	FLT99498	FLT24256		81
999478	FLT99499	FLT14256	FLT99499	FLT24256		81
999487	FLT99487	FLT14256	FLT99487	FLT24256		80
999491	FLT99247	FLT14256	FLT99247	FLT24256		80
999492	FLT99492	FLT14256	FLT99492	FLT24256		80

Mfr. Part #	FLT On/Off	On/Off Kit	FLT 2-Speed	2-Speed Kit	Also Use	Pg. #
999493	FLT99493	FLT14256	FLT99493	FLT24256		80
999494	FLT99494	FLT14256	FLT99494	FLT24256		80
999495	FLT99495	FLT14256	FLT99495	FLT24256		80
999496	FLT99423	FLT14256	FLT99423	FLT24256		80
999497	FLT99497	FLT14256	FLT99497	FLT24256		81
999498	FLT99498	FLT14256	FLT99498	FLT24256		81
999499	FLT99499	FLT14256	FLT99499	FLT24256		81
999500	FLT99500	FLT14256	FLT99500	FLT24256		-
999501	FLT99501	FLT14256	FLT99501	FLT24256		36
999502	FLT99502	FLT14256	FLT99502	FLT24256		-
999503	FLT99503	FLT14256	FLT99503	FLT24256	FLT250SK	-
999504	FLT99504	FLT142561	FLT99504	FLT242561		-
999505	FLT99505	FLT14256	FLT99505	FLT24256		-
999506	FLT99506	FLT14256	FLT99506	FLT24256	FLT300SK	37
999508	FLT99508	FLT14256	FLT99508	FLT24256		-
999509	FLT99509	FLT14256	FLT99509	FLT24256	FLT300SK	63
999510	FLT99510	FLT142561	FLT99510	FLT242561		37
999511	FLT99511	FLT14256	FLT99511	FLT24256	FLT150SK	-
999512	FLT99052	FLT14256	FLT99052	FLT24256		51
999513	FLT99053	FLT14256	FLT99053	FLT24256		51
999514	FLT99514	FLT14256	FLT99514	FLT24256	FLT150SK	-
999515	FLT99188	FLT14256	FLT99188	FLT24256	FLT150SK	57
999517	FLT99517	FLT14256	FLT99517	FLT24256		-
999521	FLT99521	FLT14256	FLT99521	FLT24256		-
999522	FLT99522	FLT14256	FLT99522	FLT24256		-
999523	FLT99523	FLT14256	FLT99523	FLT24256	FLT250SK	37
999525	FLT99525	FLT142561	FLT99525	FLT242561	FLT250SK	37
999526	FLT99526	FLT14256	FLT99526	FLT24256		-
999527	FLT99527	FLT14256	FLT99527	FLT24256		-
999528	FLT99528	FLT142561	FLT99528	FLT242561		37
999529	FLT99529	FLT14256	FLT99529	FLT24256		-
999530	FLT99530	FLT14256	FLT99530	FLT24256	FLT250SK	-
999531	FLT99531	FLT14256	FLT99531	FLT24256	FLT250SK	-
999532	FLT99532	FLT14256	FLT99532	FLT24256		37
999533	FLT99533	FLT14256	FLT99533	FLT24256		-
999534	FLT99534	FLT142561	FLT99534	FLT242561	FLT350SK	-
999537	FLT99537	FLT14256	FLT99537	FLT24256		63
999538	FLT99538	FLT14256	FLT99538	FLT24256	FLT150SK	-
999539	FLT99539	FLT14256	FLT99539	FLT24256		-
999540	FLT99540	FLT14256	FLT99540	FLT24256		-
999542	FLT99542	FLT14256	FLT99542	FLT24256		63
999627	FLT99627	FLT14-500-1	FLT99627	FLT242561		-
999700	-	-	FLT99700	FLT24256		-
999702	-	-	FLT99702	FLT242561		-
999703	-	-	FLT99807	FLT242561		-
999709	-	-	FLT98600	FLT24256		-
999710	-	-	FLT99834	FLT24256		-
999711	-	-	FLT99897	FLT24256		-
999712	-	-	FLT99899	FLT242561		-
999713	-	-	FLT99713	FLT24256		-
999714	-	-	FLT99858	FLT24256		-
999715	-	-	FLT99540	FLT24256		-
999716	-	-	FLT99854	FLT24256		-
999717	-	-	FLT99853	FLT242561		-
999718	-	-	FLT99718	FLT242561		-
999719	-	-	FLT99719	FLT24256		-
999721	-	-	FLT99721	FLT24256		-
999722	-	-	FLT99722	FLT24256		-
999723	-	-	FLT99723	FLT24256		-
999725	-	-	FLT99725	FLT24256		-
999800	FLT99800	FLT14256	FLT99800	FLT24256		64
999801	FLT99801	FLT14256	FLT99801	FLT24256		64
999802	FLT99802	FLT14256	FLT99802	FLT24256		64
999803	FLT99803	FLT14256	FLT99803	FLT24256		64
999804	FLT99466	FLT14256	FLT99466	FLT24256		63
999805	FLT99805	FLT14256	FLT99805	FLT24256		-
999806	FLT99806	FLT14256	FLT99806	FLT24256		-
999807	FLT99807	FLT142561	FLT99807	FLT242561		64
999808	FLT99808	FLT14256	FLT99808	FLT24256		-
999809	FLT99809	FLT14256	FLT99809	FLT24256		37
999810	FLT99810	FLT14256	FLT99810	FLT24256		-
999812	FLT99812	FLT14256	FLT99812	FLT24256		-
999813	FLT99813	FLT14256	FLT99813	FLT24256		-
999815	FLT99815	FLT14256	FLT99815	FLT24256		37
999816	FLT99816	FLT14256	FLT99816	FLT24256		38

Mfr. Part #	Fleetrite On/Off	On/Off Kit	FLT 2-Speed	2-Speed Kit	Also Use	Pg. #
999817	FLT99817	FLT14256	FLT998172	FLT24256		-
999818	FLT99818	FLT14256	FLT998182	FLT24256		38
999819	FLT99196	FLT14256	FLT991962	FLT24256		86
999820	FLT99466	FLT14256	FLT994662	FLT24256		63
999821	FLT99821	FLT14256	FLT998212	FLT24256		38
999822	FLT99822	FLT14256	FLT998222	FLT24256		64
999823	FLT99823	FLT14256	FLT998232	FLT24256		65
999824	FLT99824	FLT14256	FLT998242	FLT24256		38
999825	FLT99825	FLT142561	FLT998252	FLT242561		-
999826	FLT99826	FLT14256	FLT998262	FLT24256		38
999827	FLT99827	FLT142561	FLT998272	FLT242561		-
999828	FLT99828	FLT14256	FLT998282	FLT24256		38
999829	FLT99829	FLT14256	FLT998292	FLT24256		-
999830	FLT99830	FLT14256	FLT998302	FLT24256		66
999831	FLT99831	FLT14256	FLT998312	FLT24256		-
999832	FLT99832	FLT14256	FLT998322	FLT24256		-
999833	FLT99833	FLT14256	FLT998332	FLT24256		38
999834	FLT99834	FLT14256	FLT998342	FLT24256		49
999835	FLT98601	FLT14256	FLT986012	FLT24256		38
999836	FLT99836	FLT142561	FLT998362	FLT242561		-
999837	FLT99837	FLT14256	FLT998372	FLT24256		39
999838	FLT99838	FLT14256	FLT998382	FLT24256		49
999839	FLT98600	FLT14256	FLT986002	FLT24256		65
999840	FLT99840	FLT14256	FLT998402	FLT24256		39
999841	FLT99841	FLT142561	FLT998412	FLT242561		65
999842	FLT99842	FLT14256	FLT998422	FLT24256		84
999843	FLT99843	FLT142561	FLT998432	FLT242561		39
999844	FLT99844	FLT142561	FLT998442	FLT242561		65
999845	FLT99845	FLT14256	FLT998452	FLT24256		39
999846	FLT99846	FLT142561	FLT998462	FLT242561		65
999847	FLT99847	FLT14256	FLT998472	FLT24256		66
999848	FLT99848	FLT14256	FLT998482	FLT24256		77
999849	FLT99849	FLT14256	FLT998492	FLT24256		77
999850	FLT99850	FLT14256	FLT998502	FLT24256		82
999851	FLT99851	FLT14256	FLT998512	FLT24256		-
999852	FLT99852	FLT142561	FLT998522	FLT242561		-
999853	FLT99853	FLT14256	FLT998532	FLT24256		39
999854	FLT99854	FLT14256	FLT998542	FLT24256		39
999855	FLT99855	FLT14256	FLT998552	FLT24256		-
999856	FLT99856	FLT14256	FLT998562	FLT24256		-
999857	FLT99857	FLT14256	FLT998572	FLT24256		-
999858	FLT99858	FLT14256	FLT998582	FLT24256		84
999859	FLT99859	FLT14256	FLT998592	FLT24256		-
999860	FLT99860	FLT14256	FLT998602	FLT24256		-
999861	FLT99861	FLT14256	FLT998612	FLT24256		39
999862	FLT99862	FLT142561	FLT998622	FLT242561		-
999863	FLT99863	FLT14256	FLT998632	FLT24256		65
999864	FLT99864	FLT14256	FLT998642	FLT24256		-
999865	FLT99865	FLT14256	FLT998652	FLT24256	FLT275SK	65
999866	FLT98603	FLT14256	FLT986032	FLT24256		-
999867	FLT99867	FLT14256	FLT998672	FLT24256		65
999868	FLT99868	FLT14256	FLT998682	FLT24256		66
999869	FLT98604	FLT14256	FLT986042	FLT24256		66
999870	FLT99870	FLT14256	FLT998702	FLT24256		66
999871	FLT99871	FLT14256	FLT998712	FLT24256		39
999872	FLT99872	FLT14256	FLT998722	FLT24256		40
999873	FLT99873	FLT14256	FLT998732	FLT24256		40
999874	FLT99874	FLT14256	FLT998742	FLT24256		40
999875	FLT99875	FLT142561	FLT998752	FLT242561		-
999876	FLT99876	FLT14256	FLT998762	FLT24256		-
999877	FLT99877	FLT14256	FLT998772	FLT24256		-
999878	FLT99187	FLT14256	FLT991872	FLT24256		39
999879	FLT99855	FLT14256	FLT998552	FLT24256		-
999880	FLT99880	FLT14256	FLT998802	FLT24256		-
999881	FLT99881	FLT14256	FLT998812	FLT24256		-
999882	FLT98622	FLT14256	FLT986222	FLT24256		-
999883	FLT99883	FLT142561	FLT998832	FLT242561		-
999884	FLT99884	FLT14256	FLT998842	FLT24256		66
999885	FLT99885	FLT14256	FLT998852	FLT24256		40
999886	FLT99886	FLT14256	FLT998862	FLT24256		66
999887	FLT99887	FLT14256	FLT998872	FLT24256		40
999888	FLT99888	FLT14256	FLT998882	FLT24256	FLT200SK	40
999889	FLT99889	FLT142561	FLT998892	FLT242561		40
999890	FLT99897	FLT14256	FLT998972	FLT24256		66
999891	FLT99834	FLT14256	FLT998342	FLT24256		38
999892	FLT99892	FLT14256	FLT998922	FLT24256		-

Mfr. Part #	FLT On/Off	On/Off Kit	FLT 2-Speed	2-Speed Kit	Also Use	Pg. #
999893	FLT99893	FLT142561	FLT998932	FLT242561		84
999894	FLT99894	FLT14256	FLT998942	FLT24256		-
999895	FLT99895	FLT14256	FLT998952	FLT24256		-
999896	FLT99896	FLT142561	FLT998962	FLT242561		-
999897	FLT99897	FLT14256	FLT998972	FLT24256		66
999898	FLT99834	FLT14256	FLT998342	FLT24256		38
999899	FLT99899	FLT142561	FLT998992	FLT242561		40
999900	-	-	FLT999002	FLT24256		-
999901	-	-	FLT999012	FLT242561		-
999902	-	-	FLT999022	FLT24256		-
999904	-	-	FLT999042	FLT242561		-
999905	-	-	FLT999052	FLT24256		-
999906	-	-	FLT999062	FLT24256		-
999907	-	-	FLT999072	FLT24256		-
999908	-	-	FLT993462	FLT24256		-
999909	-	-	FLT999092	FLT24256		-
999910	-	-	FLT992352	FLT24256	FLT244700	-
999911	-	-	FLT992362	FLT24256	FLT244700	-
999913	-	-	FLT990232	FLT24256		-
999914	-	-	FLT990242	FLT24256		-
999915	-	-	FLT993392	FLT242561		-
999916	-	-	FLT992612	FLT24256		-
999917	-	-	FLT993412	FLT242561		-
999918	-	-	FLT999182	FLT24256	FLT244700	-
999919	-	-	FLT999192	FLT24256		-
999920	-	-	FLT990112	FLT242561		-
999921	-	-	FLT993112	FLT242561		-
999922	-	-	FLT999222	FLT24256		-
999923	-	-	FLT999012	FLT242561		-
999924	-	-	FLT992622	FLT24256		-
999925	-	-	FLT991882	FLT24256		-
999926	-	-	FLT999262	FLT24256		-
999927	-	-	FLT999272	FLT24256		-
999929	-	-	FLT999292	FLT24256		-
999930	-	-	FLT999302	FLT24256		-
999934	-	-	FLT999342	FLT24256		-
999935	-	-	FLT999352	FLT24256		-
999937	-	-	FLT999372	FLT24256		-
999939	-	-	FLT999392	FLT24256		-
999941	-	-	FLT999412	FLT24256		-
999944	-	-	FLT992412	FLT24256		-
999945	-	-	FLT998772	FLT24256		-
999946	-	-	FLT994992	FLT24256		-
999947	-	-	FLT994982	FLT24256		-
999948	-	-	FLT994552	FLT242561		-
999949	-	-	FLT993662	FLT24256		-
999950	-	-	FLT999502	FLT24256		-
999951	-	-	FLT999512	FLT24256		-
999952	-	-	FLT999522	FLT24256		-
999953	-	-	FLT998752	FLT24256		-
999954	-	-	FLT999542	FLT24256		-
999955	-	-	FLT999552	FLT24256		-
999957	-	-	FLT998772	FLT24256		-
999958	-	-	FLT999582	FLT24256		-
999959	-	-	FLT998282	FLT24256		-
999960	-	-	FLT993192	FLT24256		-
999961	-	-	FLT993822	FLT24256		-
999962	-	-	FLT994612	FLT24256		-
999963	-	-	FLT991872	FLT24256		-
999964	-	-	FLT998852	FLT24256		-
999965	-	-	FLT992512	FLT242561		-
999966	-	-	FLT998762	FLT24256		-
999967	-	-	FLT993362	FLT242561		-
999968	-	-	FLT991422	FLT242561		-
999969	-	-	FLT992692	FLT24256		-
999970	-	-	FLT999702	FLT24256		-
999971	-	-	FLT999712	FLT24256		-
999972	-	-	FLT999722	FLT24256		-
999973	-	-	FLT997252	FLT24256		-
999974	-	-	FLT999742	FLT24256		-
999975	-	-	FLT999752	FLT24256		-
999976	-	-	FLT999762	FLT24256		-
999977	-	-	FLT986082	FLT24256		-
999978	-	-	FLT991892	FLT24256		-
999979	-	-	FLT999792	FLT24256		-

Mfr. Part #	Fleetrite On/Off	On/Off Kit	FLT 2-Speed	2-Speed Kit	Also Use	Pg. #
999980	-	-	FLT999802	FLT24256		-
999981	-	-	FLT999812	FLT24256		-
999983	-	-	FLT999832	FLT24256		-
999984	-	-	FLT999842	FLT24256		-
999985	-	-	FLT990402	FLT24256		-
999986	-	-	FLT994162	FLT24256		-
999987	-	-	FLT999872	FLT242561		-
999988	-	-	FLT999882	FLT24256		-
999989	-	-	FLT992232	FLT24256		-
999990	-	-	FLT999902	FLT24256		-
999992	-	-	FLT991182	FLT24256		-
999993	-	-	FLT997222	FLT24256		-
999994	-	-	FLT997212	FLT24256		-
999995	-	-	FLT999952	FLT24256		-
999996	-	-	FLT999962	FLT24256		-
999997	-	-	FLT999972	FLT24256		-
999998	-	-	FLT996782	FLT24256		-
999999	-	-	FLT999992	FLT24256		-
99Axxxx						
99A4700	-	FLT24256	-	-	FLT244700	6
99A4701	-	FLT24256	-	-	FLT244700	6
99A4717	-	FLT24256	-	-	FLT244700	6
99A8104	-	-	FLT995582	FLT24256		-
99A8105	-	-	FLT997542	FLT24256		-
99A8106	-	-	FLT997552	FLT24256		-
99A8107	-	-	FLT997562	FLT24256		-
99A8110	-	-	FLT995952	FLT24256		-
99A8112	-	-	FLT995962	FLT24256		-
99A8121	-	-	FLT981212	FLT24256		-
99A8131	FLT99580	FLT14256	FLT995802	FLT24256		-
99A8131-2	-	-	FLT995802	FLT24256		-
99A8132	FLT99576	FLT14256	FLT995762	FLT24256		-
99A8133	-	-	FLT993242	FLT24256		-
99A8136	-	-	FLT996152	FLT24256		-
99A8138	-	-	FLT996172	FLT24256		-
99A8143	-	-	FLT996182	FLT24256		-
99A8145	-	-	FLT996192	FLT24256		-
99A8146	-	-	FLT997572	FLT24256		-
99A8149	-	-	FLT996222	FLT24256		-
99A8177	-	-	FLT997882	FLT24256		-
99A8181	-	-	FLT995582	FLT24256		-
99A8182	-	-	FLT997542	FLT24256		-
99A8183	-	-	FLT997552	FLT24256		-
99A8184	-	-	FLT997562	FLT24256		-
99A8187	-	-	FLT981872	FLT24256		-
99A8188	-	-	FLT996472	FLT24256		-
99A8189	-	-	FLT996492	FLT24256		-
99A8199	-	-	FLT981992	FLT24256		-
99A8210	-	-	FLT986542	FLT24256		-
99A8600	FLT98600	FLT14256	FLT986002	FLT24256		49
99A8601	FLT98601	FLT14256	FLT986012	FLT24256		49
99A8601-2	-	-	FLT986012	FLT24256		49
99A8602	FLT99860	FLT14256	FLT998602	FLT24256		-
99A8603	FLT98603	FLT14256	FLT986032	FLT24256		-
99A8604	FLT98604	FLT14256	FLT986042	FLT24256		-
99A8607	FLT98607	FLT14256	FLT986072	FLT24256		78
99A8607-2	-	-	FLT986072	FLT24256		78
99A8608	FLT98608	FLT14256	FLT986082	FLT24256		-
99A8609	FLT98609	FLT14256	FLT986092	FLT24256		-
99A8610-2	-	-	FLT991602	FLT24256		-
99A8611	FLT98611	FLT14256	FLT986112	FLT24256		-
99A8613	FLT98613	FLT14256	FLT986132	FLT24256		-
99A8616	FLT98616	FLT14256	FLT986162	FLT24256		-
99A8620	FLT98620	FLT14256	FLT986202	FLT24256		70
99A8621	FLT98621	FLT14256	FLT986212	FLT24256		70
99A8621-2	-	-	FLT986212	FLT24256		-
99A8624-2	-	-	FLT986242	FLT24256	FLT300SK	-
99A8627	FLT98627	FLT14256	FLT986272	FLT24256		85
99A8631	FLT98631	FLT14256	FLT986312	FLT24256		85
99A8634	FLT98634	FLT14256	FLT986342	FLT24256		-
99A8635	FLT98635	FLT14256	FLT986352	FLT24256		78
99A8638	FLT98638	FLT14256	FLT986382	FLT24256		83
99A8639	FLT99352	FLT14256	FLT993522	FLT24256		62
99A8640	FLT99254	FLT14256	FLT992542	FLT24256		-
99A8642	FLT98642	FLT14256	FLT986422	FLT24256		-

Mfr. Part #	FLT On/Off	On/Off Kit	FLT 2-Speed	2-Speed Kit	Also Use	Pg. #
99A8643	FLT98643	FLT14256	FLT986432	FLT24256		-
99A8646	FLT98646	FLT14256	FLT986462	FLT24256		-
99A8647	FLT98647	FLT14256	FLT986472	FLT24256		23
99A8648	FLT98648	FLT14256	FLT986482	FLT24256		-
99A8650	FLT98650	FLT14256	FLT986502	FLT24256		70
99A8652	FLT98652	FLT14256	FLT986522	FLT24256		-
99A8652-2	-	-	FLT986522	FLT24256		-
99A8653	FLT98653	FLT14256	FLT986532	FLT24256		-
99A8653-2	-	-	FLT986532	FLT24256		-
99A8654	FLT98654	FLT14256	FLT986542	FLT24256		-
99A8654-2	-	-	FLT986542	FLT24256		-
99A8655	FLT98655	FLT14256	FLT986552	FLT24256		70
99A8655-2	-	-	FLT986552	FLT24256		-
99A8656	FLT98656	FLT14256	FLT986562	FLT24256		-
99A8657	FLT98657	FLT14256	FLT986572	FLT24256		-
99A8657-2	-	-	FLT986572	FLT24256		-
99A9007	FLT99007	FLT14256	FLT990072	FLT24256		71
99A9023	FLT99023	FLT14256	FLT990232	FLT24256		78
99A9024	FLT99024	FLT14256	FLT990242	FLT24256		78
99A9037	FLT99037	FLT14256	FLT990372	FLT24256		24
99A9044	FLT99044	FLT14256	FLT990442	FLT24256		24
99A9046	FLT99046	FLT14256	FLT990462	FLT24256		24
99A9054	FLT99054	FLT14256	FLT990542	FLT24256		51
99A9054-2	-	-	FLT990542	FLT24256		-
99A9056	FLT99056	FLT14256	FLT990562	FLT24256		52
99A9057	FLT99057	FLT14256	FLT990572	FLT24256		52
99A9061	FLT99061	FLT14256	FLT990612	FLT24256		72
99A9062	FLT99062	FLT14256	FLT990622	FLT24256		72
99A9062-2	-	-	FLT990622	FLT24256		-
99A9064	FLT99064	FLT14256	FLT990642	FLT24256		72
99A9064-2	-	-	FLT990642	FLT24256		-
99A9065	FLT99065	FLT14256	FLT990652	FLT24256		73
99A9065-2	-	-	FLT990652	FLT24256		-
99A9067	FLT99067	FLT14256	FLT990672	FLT24256		-
99A9067-2	-	-	FLT990672	FLT24256		-
99A9068	FLT99068	FLT14256	FLT990682	FLT24256		24
99A9074	FLT99074	FLT14256	FLT990742	FLT24256		25
99A9074-2	-	-	FLT990742	FLT24256		-
99A9087	FLT99087	FLT14256	FLT990872	FLT24256		-
99A9088-2	-	-	FLT990882	FLT24256		-
99A9097	FLT99097	FLT14256	FLT990972	FLT24256		53
99A9110	FLT99110	FLT14256	FLT991102	FLT24256	FLT350SK	54
99A9112	FLT99112	FLT14256	FLT991122	FLT24256		54
99A9133	FLT99133	FLT14256	FLT991332	FLT24256		56
99A9134	FLT99134	FLT14256	FLT991342	FLT24256		56
99A9146	FLT99146	FLT14256	FLT991462	FLT24256		73
99A9147	FLT99147	FLT14256	FLT991472	FLT24256		-
99A9161	FLT99161	FLT14256	FLT991612	FLT24256		27
99A9165	FLT99165	FLT14256	FLT991652	FLT24256		-
99A9166	FLT99166	FLT14256	FLT991662	FLT24256		-
99A9168	FLT99168	FLT14256	FLT991682	FLT24256		57
99A9189	FLT99189	FLT14256	FLT991892	FLT24256		27
99A9191	FLT99191	FLT14256	FLT991912	FLT24256	FLT300SK	28
99A9194	FLT99194	FLT14256	FLT991942	FLT24256		28
99A9198	FLT99198	FLT14256	FLT991982	FLT24256		58
99A9216	FLT99216	FLT14256	FLT992162	FLT24256	FLT250SK	74
99A9222-2	-	-	FLT992222	FLT24256		-
99A9223	FLT99223	FLT14256	FLT992232	FLT24256		74
99A9223-2	-	-	FLT992232	FLT24256		-
99A9235	FLT99235	FLT14256	FLT992352	FLT24256	FLT244700	-
99A9238	FLT99238	FLT14256	FLT992382	FLT24256		59
99A9254	FLT99254	FLT14256	FLT992542	FLT24256		-
99A9256	FLT99256	FLT14256	FLT992562	FLT24256	FLT300SK	75
99A9261	FLT99261	FLT14256	FLT992612	FLT24256		-
99A9263	FLT99263	FLT14256	FLT992632	FLT24256		59
99A9263-2	-	-	FLT992632	FLT24256		-
99A9264	FLT99264	FLT14256	FLT992642	FLT24256		59
99A9268	FLT99268	FLT14256	FLT992682	FLT24256		75
99A9285	FLT99285	FLT14256	FLT992852	FLT24256		75
99A9292	FLT99070	FLT14256	FLT990702	FLT24256		24
99A9293-2	-	-	FLT992932	FLT24256		-
99A9306	FLT99306	FLT14256	FLT993062	FLT24256		60
99A9307	FLT99307	FLT14256	FLT993072	FLT24256		30
99A9313	FLT99313	FLT14256	FLT993132	FLT24256		31
99A9319	FLT99319	FLT14256	FLT993192	FLT24256		31

Mfr. Part #	Fleetrite On/Off	On/Off Kit	FLT 2-Speed	2-Speed Kit	Also Use	Pg. #
99A9324	FLT99324	FLT14256	FLT993242	FLT24256		61
99A9334	FLT99334	FLT14256	FLT993342	FLT24256		32
99A9335	FLT99335	FLT14256	FLT993352	FLT24256		-
99A9346	FLT99346	FLT14256	FLT993462	FLT24256		32
99A9360	FLT99360	FLT14256	FLT993602	FLT24256		33
99A9361	FLT99361	FLT14256	FLT993612	FLT24256		33
99A9362	FLT99362	FLT14256	FLT993622	FLT24256		33
99A9366	FLT99366	FLT14256	FLT993662	FLT24256		33
99A9377	FLT99377	FLT14256	FLT993772	FLT24256		34
99A9381	FLT99381	FLT14256	FLT993812	FLT24256		84
99A9383-2	-	-	FLT993832	FLT24256		-
99A9404	FLT99404	FLT14256	FLT994042	FLT24256		-
99A9405	FLT99405	FLT14256	FLT994052	FLT24256		35
99A9410	FLT99410	FLT14256	FLT994102	FLT24256		76
99A9410-2	-	-	FLT994102	FLT24256		-
99A9428	FLT99428	FLT14256	FLT994282	FLT24256		36
99A9437	FLT99437	FLT14256	FLT994372	FLT24256		32
99A9446	FLT99446	FLT14256	FLT994462	FLT24256		62
99A9451	FLT99451	FLT14256	FLT994512	FLT24256		-
99A9461	FLT99461	FLT14256	FLT994612	FLT24256		-
99A9502	FLT99502	FLT14256	FLT995022	FLT24256		-
99A9502-2	-	-	FLT995022	FLT24256		-
99A9505	FLT99505	FLT14256	FLT995052	FLT24256		-
99A9506	FLT99506	FLT14256	FLT995062	FLT24256		37
99A9509	FLT99509	FLT14256	FLT995092	FLT24256	FLT300SK	63
99A9511	FLT99511	FLT14256	FLT995112	FLT24256		-
99A9512	FLT99512	FLT14256	FLT995122	FLT24256		51
99A9512-2	-	-	FLT995122	FLT24256		-
99A9515	FLT99188	FLT14256	FLT991882	FLT24256		57
99A9521	FLT99521	FLT14256	FLT995212	FLT24256		-
99A9521-2	-	-	FLT995212	FLT24256		-
99A9522	FLT99522	FLT14256	FLT995222	FLT24256		-
99A9526	FLT99526	FLT14256	FLT995262	FLT24256		-
99A9529	FLT99529	FLT14256	FLT995292	FLT24256		-
99A9531	FLT99531	FLT14256	FLT995312	FLT24256	FLT250SK	-
99A9542	FLT99542	FLT14256	FLT995422	FLT24256		63
99A9547	FLT99547	FLT14256	FLT995472	FLT24256		-
99A9547-2	-	-	FLT995472	FLT24256		-
99A9548	FLT99548	FLT14256	FLT995482	FLT24256		63
99A9551	FLT99551	FLT14256	FLT995512	FLT24256		-
99A9552	FLT99552	FLT14256	FLT995522	FLT24256		-
99A9553	FLT99553	FLT14256	FLT995532	FLT24256		-
99A9553-2	-	-	FLT995532	FLT24256		-
99A9554	FLT99554	FLT14256	FLT995542	FLT24256		-
99A9554-2	-	-	FLT995542	FLT24256		-
99A9555	FLT99555	FLT14200	FLT995552	FLT24-200		-
99A9555-2	-	-	FLT995552	FLT24-200		-
99A9556	FLT99556	FLT14200	FLT995562	FLT24-200		-
99A9556-2	-	-	FLT995562	FLT24-200		-
99A9557	FLT99557	FLT14200	FLT995572	FLT24-200		-
99A9557-2	-	-	FLT995572	FLT24-200		-
99A9558	-	-	FLT995582	FLT24256		-
99A9559	FLT99559	FLT14256	FLT995592	FLT24256		-
99A9559-2	-	-	FLT995592	FLT24256		-
99A9560	FLT99560	FLT14256	FLT995602	FLT24256		-
99A9562	FLT99562	FLT14256	FLT995622	FLT24256		78
99A9562-2	-	-	FLT995622	FLT24256		-
99A9569	FLT99569	FLT14256	FLT995692	FLT24256		-
99A9569-2	-	-	FLT995692	FLT24256		-
99A9570	FLT99570	FLT14256	FLT995702	FLT24256		77
99A9570-2	-	-	FLT995702	FLT24256		-
99A9574	FLT99574	FLT14256	FLT995742	FLT24256		-
99A9575	FLT99575	FLT14256	FLT995752	FLT24256		-
99A9576	FLT99576	FLT14256	FLT995762	FLT24256		-
99A9576-2	-	-	FLT995762	FLT24256		-
99A9577	FLT99577	FLT14256	FLT995772	FLT24256		-
99A9578	FLT99578	FLT14256	FLT995782	FLT24256		-
99A9579	FLT99579	FLT14256	FLT995792	FLT24256		-
99A9580	FLT99580	FLT14256	FLT995802	FLT24256		-
99A9581	FLT99581	FLT14256	FLT995812	FLT24256		-
99A9581-2	-	-	FLT995812	FLT24256		-
99A9584	FLT99584	FLT14256	FLT995842	FLT24256		-
99A9584-2	-	-	FLT995842	FLT24256		-
99A9585	FLT99585	FLT14256	FLT995852	FLT24256		-
99A9586	FLT99586	FLT14-500	FLT995862	FLT24256		-

Mfr. Part #	FLT On/Off	On/Off Kit	FLT 2-Speed	2-Speed Kit	Also Use	Pg. #
99A9589	FLT99589	FLT14-500	FLT995892	FLT24256		-
99A9590	FLT99590	FLT14-500	FLT995902	FLT24256		85
99A9591	FLT99591	FLT14-500	FLT995912	FLT24256		-
99A9592	FLT99592	FLT14-500	FLT995922	FLT24256		85
99A9594	FLT99594	FLT14-500	FLT995942	FLT24256		-
99A9595	FLT99595	FLT14-500	FLT995952	FLT24256		-
99A9596	FLT99596	FLT14-500	FLT995962	FLT24256		-
99A9599	FLT99599	FLT14-500	FLT995992	FLT24256	FLT350SK	-
99A9600	FLT99600	FLT14-500	FLT996002	FLT24256		-
99A9600-2	-	-	FLT996002	FLT24256		-
99A9601	FLT99601	FLT14-500	FLT996012	FLT24256		-
99A9610	FLT99610	FLT14-500	FLT996102	FLT24256		-
99A9610-2	-	-	FLT996102	FLT24256		-
99A9611	FLT99611	FLT14-500	FLT996112	FLT24256		-
99A9612	FLT99612	FLT14-500	FLT996122	FLT24256		63
99A9613	FLT99613	FLT14-500	FLT996132	FLT24256		-
99A9614	FLT99614	FLT14-500	FLT996142	FLT24256		-
99A9615	FLT99615	FLT14-500	FLT996152	FLT24256		-
99A9616	FLT99616	FLT14-500	FLT996162	FLT24256	FLT250SK	-
99A9617	FLT99617	FLT14-500	FLT996172	FLT24256		-
99A9618	FLT99618	FLT14-500	FLT996182	FLT24256		-
99A9619	FLT99619	FLT14-500	FLT996192	FLT24256		-
99A9620	FLT99620	FLT14-500	FLT996202	FLT24256		77
99A9621	FLT99621	FLT14-500	FLT996212	FLT24256		77
99A9622	FLT99622	FLT14-500	FLT996222	FLT24256		-
99A9624	FLT99624	FLT14-500	FLT996242	FLT24256	FLT244700	-
99A9625	-	-	FLT996252	FLT24256		-
99A9626	FLT99626	FLT14-500	FLT996262	FLT24256		-
99A9628	FLT99628	FLT14-500	FLT996282	FLT24256		-
99A9629	FLT99629	FLT14-500	FLT996292	FLT24256		-
99A9630	FLT99630	FLT14-500	FLT996302	FLT24256		63
99A9632	FLT99632	FLT14-500	FLT996322	FLT24256		63
99A9633	-	-	FLT996332	FLT24256		-
99A9634	-	-	FLT996342	FLT24256		-
99A9635	-	-	FLT996352	FLT24256		-
99A9636	-	-	FLT996362	FLT24256		-
99A9637	FLT99637	FLT14-500	FLT996372	FLT24256		-
99A9638	FLT99638	FLT14-500	FLT996382	FLT24256		-
99A9639	FLT99639	FLT14-500	FLT996392	FLT24256	FLT200SK	-
99A9640	FLT99640	FLT14-500	FLT996402	FLT24256	FLT200SK	-
99A9641	FLT99641	FLT14-500	FLT996412	FLT24256		-
99A9642	FLT99642	FLT14-500	FLT996422	FLT24256		-
99A9642-2	-	-	FLT996422	FLT24256		-
99A9643	FLT99643	FLT14-500	FLT996432	FLT24256		-
99A9643-2	-	-	FLT996432	FLT24256		-
99A9644	FLT99644	FLT14-500	FLT996442	FLT24256		-
99A9644-2	-	-	FLT996442	FLT24256		-
99A9645	FLT99645	FLT14-500	FLT996452	FLT24256		-
99A9645-2	-	-	FLT996452	FLT24256		-
99A9646	FLT99646	FLT14-500	FLT996462	FLT24256		-
99A9646-2	-	-	FLT996462	FLT24256		-
99A9647	FLT99647	FLT14-500	FLT996472	FLT24256		-
99A9648	FLT99648	FLT14-500	FLT996482	FLT24-200		77
99A9649	FLT99649	FLT14-500	FLT996492	FLT24256		-
99A9650	FLT99650	FLT14-500	FLT996502	FLT24256		70
99A9651	FLT99651	FLT14-500	FLT996512	FLT24256	FLT250SK	-
99A9656	FLT99656	FLT14-500	FLT996562	FLT24256		-
99A9656-2	-	-	FLT996562	FLT24256		-
99A9659	FLT99659	FLT14-500	FLT996592	FLT24256		-
99A9660	FLT99660	FLT14-500	FLT996602	FLT24256		-
99A9661	FLT99661	FLT14-500	FLT996612	FLT24256		-
99A9662	FLT99662	FLT14-500	FLT996622	FLT24256		-
99A9662-2	-	-	FLT996622	FLT24256		-
99A9663	FLT99663	FLT14-500	FLT996632	FLT24256		64
99A9664	FLT99664	FLT14-500	FLT996642	FLT24256		-
99A9665	FLT99665	FLT14-500	FLT996652	FLT24256		-
99A9678	FLT99678	FLT14-500	FLT996782	FLT24256		-
99A9700	-	-	FLT997002	FLT24256		-
99A9709	-	-	FLT997092	FLT24256		-
99A9710	-	-	FLT997102	FLT24256		-
99A9711	-	-	FLT997112	FLT24256		-
99A9714	-	-	FLT997142	FLT24256		-
99A9715	-	-	FLT997152	FLT24256		-
99A9720	-	-	FLT997202	FLT24256		-
99A9729	-	-	FLT997292	FLT24256		-

Cross Reference Horton-style compatible

Mfr. Part #	Fleetrite On/Off	On/Off Kit	FLT 2-Speed	2-Speed Kit	Also Use	Pg. #
99A9730	-	-	FLT997202	FLT24256		-
99A9731	-	-	FLT998452	FLT24256		-
99A9732	-	-	FLT997322	FLT24256		-
99A9736	-	-	FLT997362	FLT24256		-
99A9737	-	-	FLT986562	FLT24256		-
99A9740	-	-	FLT995602	FLT24256		-
99A9742	-	-	FLT997422	FLT24256		-
99A9743	-	-	FLT997432	FLT24256		-
99A9744	-	-	FLT997442	FLT24256		-
99A9745	-	-	FLT997452	FLT24256		-
99A9746	-	-	FLT986502	FLT24256		-
99A9747	-	-	FLT997472	FLT24256		-
99A9748	-	-	FLT997482	FLT24256		-
99A9749	-	-	FLT986092	FLT24256		-
99A9750	-	-	FLT998332	FLT24256		-
99A9751	FLT99751	FLT14256	FLT997512	FLT24256		-
99A9751-2	-	-	FLT997512	FLT24256		-
99A9754	-	-	FLT997542	FLT24256		-
99A9755	-	-	FLT997552	FLT24256		-
99A9756	-	-	FLT997562	FLT24256		-
99A9757	-	-	FLT997572	FLT24256		-
99A9760	-	-	FLT997602	FLT24256		-
99A9761	-	-	FLT995902	FLT24256		-
99A9762	-	-	FLT995922	FLT24256		-
99A9763	-	-	FLT995912	FLT24256		-
99A9764	-	-	FLT997642	FLT24256		-
99A9766	-	-	FLT997662	FLT24256		-
99A9767	-	-	FLT997672	FLT24256		-
99A9768	-	-	FLT995942	FLT24256		-
99A9770	-	-	FLT997702	FLT24256		-
99A9771	-	-	FLT997712	FLT24256		-
99A9774	-	-	FLT997742	FLT24256		-
99A9775	-	-	FLT997752	FLT24256		-
99A9776	-	-	FLT997762	FLT24256		-
99A9777	-	-	FLT996392	FLT24256	FLT200SK	-
99A9778	FLT99778	FLT14256	FLT997782	FLT24256		-
99A9778-2	-	-	FLT997782	FLT24256		-
99A9779	FLT99779	FLT14256	FLT997792	FLT24256		-
99A9779-2	-	-	FLT997792	FLT24256		-
99A9780	-	-	FLT995772	FLT24256		-
99A9781	-	-	FLT997812	FLT24256		-
99A9782	-	-	FLT997822	FLT24256		-
99A9783	-	-	FLT997832	FLT24256		-
99A9786	-	-	FLT997862	FLT24256		-
99A9787	-	-	FLT997872	FLT24256		-
99A9788	-	-	FLT997882	FLT24256		-
99A9789	-	-	FLT997892	FLT24256		-
99A9790	-	-	FLT997902	FLT24256		-
99A9791	-	-	FLT997912	FLT24256		-
99A9792	-	-	FLT996652	FLT24256		-
99A9793	-	-	FLT997932	FLT24256		-
99A9794	-	-	FLT997942	FLT24256		-
99A9795	-	-	FLT997952	FLT24256		-
99A9796	-	-	FLT997962	FLT24256		-
99A9797	-	-	FLT996432	FLT24256		-
99A9798	-	-	FLT995892	FLT24256		-
99A9799	-	-	FLT997992	FLT24256		-
99A9801	FLT99801	FLT14256	FLT998012	FLT24256		64
99A9807	FLT99807	FLT14256	FLT998072	FLT24256		64
99A9809	FLT99809	FLT14256	FLT998092	FLT24256		37
99A9816	FLT99816	FLT14256	FLT998162	FLT24256		38
99A9817	FLT99817	FLT14256	FLT998172	FLT24256		-
99A9818	FLT99818	FLT14256	FLT998182	FLT24256		38
99A9829	FLT99829	FLT14256	FLT998292	FLT24256		38
99A9830	FLT99830	FLT14256	FLT998302	FLT24256		-
99A9833	FLT99833	FLT14256	FLT998332	FLT24256		-
99A9837	FLT99837	FLT14256	FLT998372	FLT24256		-
99A9840	FLT99840	FLT14256	FLT998402	FLT24256		65
99A9842	FLT99842	FLT14256	FLT998422	FLT24256		65
99A9845	FLT99845	FLT14256	FLT998452	FLT24256		65
99A9847	FLT99847	FLT14256	FLT998472	FLT24256		65
99A9850	FLT99850	FLT14256	FLT998502	FLT24256		77
99A9855	FLT99855	FLT14256	FLT998552	FLT24256		39
99A9856	FLT99856	FLT14256	FLT998562	FLT24256		39
99A9858	FLT99858	FLT14256	FLT998582	FLT24256		-

Mfr. Part #	FLT On/Off	On/Off Kit	FLT 2-Speed	2-Speed Kit	Also Use	Pg. #
99A9859	FLT99859	FLT14256	FLT998592	FLT24256		84
99A9861	FLT99861	FLT14256	FLT998612	FLT24256		-
99A9863	FLT99863	FLT14256	FLT998632	FLT24256		-
99A9864	FLT99864	FLT14256	FLT998642	FLT24256		65
99A9865	FLT99865	FLT14256	FLT998652	FLT24256		65
99A9867	FLT99867	FLT14256	FLT998672	FLT24256		-
99A9867-2	-	-	FLT998672	FLT24256		-
99A9868	FLT99868	FLT14256	FLT998682	FLT24256		65
99A9870	FLT99870	FLT14256	FLT998702	FLT24256		66
99A9871	FLT99871	FLT14256	FLT998712	FLT24256		66
99A9872	FLT99872	FLT14256	FLT998722	FLT24256		39
99A9873	FLT99873	FLT14256	FLT998732	FLT24256		40
99A9874	FLT99874	FLT14256	FLT998742	FLT24256		40
99A9875	-	-	FLT997862	FLT24256		-
99A9876	FLT99876	FLT14256	FLT998762	FLT24256		-
99A9877	FLT99877	FLT14256	FLT998772	FLT24256		-
99A9878	FLT99187	FLT14256	FLT991872	FLT24256		-
99A9879	FLT99855	FLT14256	FLT998552	FLT24256		39
99A9885	FLT99885	FLT14256	FLT998852	FLT24256		66
99A9886	FLT99886	FLT14256	FLT998862	FLT24256		40
99A9887	FLT99887	FLT14256	FLT998872	FLT24256		66
99A9892	FLT99892	FLT14256	FLT998922	FLT24256		-
99A9897	FLT99897	FLT14256	FLT998972	FLT24256		66
99A9898	FLT99834	FLT14256	FLT998342	FLT24256		38
99A9906	-	-	FLT999002	FLT24256		-
99A9907	-	-	FLT999022	FLT24256		-
99A9914	-	-	FLT990242	FLT24256		-
99A9916	-	-	FLT992612	FLT24256		-
99A9918	-	-	FLT999182	FLT24256	FLT244700	-
99A9924	-	-	FLT992622	FLT24256		-
99A9925	-	-	FLT991882	FLT24256		-
99A9950	-	-	FLT999502	FLT24256		-
99A9953	-	-	FLT998752	FLT24256		-
99A9957	-	-	FLT998772	FLT24256		-
99A9962	-	-	FLT994612	FLT24256		-
99A9963	-	-	FLT991872	FLT24256		-
99A9964	-	-	FLT998852	FLT24256		-
99A9966	-	-	FLT998762	FLT24256		-
99A9970	-	-	FLT999702	FLT24256		-
99A9972	-	-	FLT999722	FLT24256		-
99A9974	-	-	FLT998502	FLT24256		-
99A9977	-	-	FLT9986082	FLT24256		-
99A9979	-	-	FLT999792	FLT24256		-
99A9984	-	-	FLT999842	FLT24256		-
99A9988	-	-	FLT999882	FLT24256		-
99A9990	-	-	FLT999902	FLT24256		-
99A9993	-	-	FLT997222	FLT24256		-
99A9994	-	-	FLT997212	FLT24256		-
99A9995	-	-	FLT999952	FLT24256		-
99A9996	-	-	FLT999962	FLT24256		-
99A9998	-	-	FLT996782	FLT24256		-

Mfr. Part #	Fleetrite Part #	Head	Bracket	Pilot Adapter	Special	New Fan Required	Mfr. Part #	Fleetrite Part #	Head	Bracket	Pilot Adapter	Special	New Fan Required
BORGWARNER							EATON						
010010980	FLT51120000	FLTRVH05	FLTRV112	-	-	-	16233-2	FLT72010100	FLTRVH07	FLTRV201	FLTRVP01	-	-
010010981	FLT21060002	FLTRVH02	FLTRV106	-	FLTRVS02	-	16650-2	FLT72011000	FLTRVH07	FLTRV201	FLTRVP10	-	-
010010992	FLT42040000	FLTRVH04	FLTRV204	-	-	-	16686-1	FLT22030000	FLTRVH02	FLTRV203	-	-	-
010010993	FLT42200500	FLTRVH04	FLTRV220	FLTRVP05	-	-	16686-2	FLT22030000	FLTRVH02	FLTRV203	-	-	-
010011210	FLT41130000	FLTRVH04	FLTRV113	-	-	-	16784-3	FLT72010101	FLTRVH07	FLTRV201	FLTRVP01	FLTRVS01	-
010011657	FLT42180000	FLTRVH04	FLTRV218	-	-	-	17038-1	FLT72010101	FLTRVH07	FLTRV201	FLTRVP01	FLTRVS01	-
010011790	FLT42040000	FLTRVH04	FLTRV204	-	-	-	17235-1	FLT52010100	FLTRVH05	FLTRV201	FLTRVP01	-	-
010018941	FLT42200500	FLTRVH04	FLTRV220	FLTRVP05	-	-	17284-1	FLT42010100	FLTRVH04	FLTRV201	FLTRVP01	-	-
010019000	FLT21170000	FLTRVH02	FLTRV117	-	-	-	17310-1	FLT32261500	FLTRVH03	FLTRV226	FLTRVP15	-	-
010019556	FLT061040003	FLTRVH06	FLTRV104	-	FLTRVS03	-	17390-1	FLT72010101	FLTRVH07	FLTRV201	FLTRVP01	FLTRVS01	-
010019561	FLT21080003	FLTRVH02	FLTRV108	-	FLTRVS03	-	17398-1	FLT12030800	FLTRVH01	FLTRV203	FLTRVP08	-	-
010019721	FLT041010000	FLTRVH04	FLTRV101	-	-	-	17405-1	FLT22240203	FLTRVH02	FLTRV224	FLTRVP02	FLTRVS03	-
010020069	FLT52200500	FLTRVH05	FLTRV220	FLTRVP05	-	-	17449-1	FLT22081303	FLTRVH02	FLTRV208	FLTRVP13	FLTRVS03	Yes
010020164	FLT61120002	FLTRVH06	FLTRV112	-	FLTRVS02	-	17456-1	FLT42010000	FLTRVH04	FLTRV201	-	-	-
010020509	FLT031110000	FLTRVH03	FLTRV111	-	-	-	17482-1	FLT22030100	FLTRVH02	FLTRV203	FLTRVP01	-	Yes
010020552	FLT031110000	FLTRVH03	FLTRV111	-	-	-	17497-1	FLT22150700	FLTRVH02	FLTRV215	FLTRVP07	-	-
010020755	FLT0021090000	FLTRVH02	FLTRV109	-	-	-	17539-1	FLT62010100	FLTRVH06	FLTRV201	FLTRVP01	-	-
010020791	FLT031110000	FLTRVH03	FLTRV111	-	-	-	17545-1	FLT22030000	FLTRVH02	FLTRV203	-	-	-
010020805	FLT41050000	FLTRVH04	FLTRV105	-	-	-	17562-1	FLT22230000	FLTRVH02	FLTRV223	-	-	Yes
010020893	FLT0021090000	FLTRVH02	FLTRV109	-	-	-	17581-1	FLT72010100	FLTRVH07	FLTRV201	FLTRVP01	-	-
010020914	FLT0021090000	FLTRVH02	FLTRV109	-	-	-	17585-1	FLT52100000	FLTRVH05	FLTRV210	-	-	-
010021288	FLT071040003	FLTRVH07	FLTRV104	-	FLTRVS03	-	17595-1	FLT72010100	FLTRVH07	FLTRV201	FLTRVP01	-	-
010021314	FLT41020000	FLTRVH04	FLTRV102	-	-	-	17637-2	FLT61160002	FLTRVH06	FLTRV116	-	FLTRVS02	-
010021454	FLT71050000	FLTRVH07	FLTRV105	-	-	-	17650-1	FLT22030000	FLTRVH02	FLTRV203	-	-	-
010021483	FLT21070000	FLTRVH02	FLTRV107	-	-	-	17657-1	FLT72010100	FLTRVH07	FLTRV201	FLTRVP01	-	-
010021488	FLT41030000	FLTRVH04	FLTRV103	-	-	-	17671-1	FLT12030000	FLTRVH01	FLTRV203	-	-	-
010021511	FLT21060000	FLTRVH02	FLTRV106	-	-	-	17708-1	FLT42010000	FLTRVH04	FLTRV201	-	-	-
010021524	FLT72010101	FLTRVH07	FLTRV201	FLTRVP01	FLTRVS01	-	17708-2	FLT42010000	FLTRVH04	FLTRV201	-	-	-
010021525	FLT72010101	FLTRVH07	FLTRV201	FLTRVP01	FLTRVS01	-	17713-1	FLT52020003	FLTRVH05	FLTRV202	-	FLTRVS03	-
010021526	FLT061040003	FLTRVH06	FLTRV104	-	FLTRVS03	-	17740-3	FLT11060002	FLTRVH01	FLTRV106	-	FLTRVS02	Yes
010021530	FLT061050000	FLTRVH06	FLTRV105	-	-	-	17740-4	FLT11060002	FLTRVH01	FLTRV106	-	FLTRVS02	Yes
010021531	FLT51050000	FLTRVH05	FLTRV105	-	-	-	17856-1	FLT42010101	FLTRVH04	FLTRV201	FLTRVP01	FLTRVS01	-
010021532	FLT41050000	FLTRVH04	FLTRV105	-	-	-	17858-1	FLT32260903	FLTRVH03	FLTRV226	FLTRVP09	FLTRVS03	-
010021584	FLT42040000	FLTRVH04	FLTRV204	-	-	-	17862-1	FLT72010100	FLTRVH07	FLTRV201	FLTRVP01	-	-
010021585	FLT52200600	FLTRVH05	FLTRV220	FLTRVP06	-	-	17866-1	FLT52200500	FLTRVH05	FLTRV220	FLTRVP05	-	-
010021586	FLT42130900	FLTRVH04	FLTRV213	FLTRVP09	-	-	17881-1	FLT12230000	FLTRVH01	FLTRV223	-	-	-
010021587	FLT42180000	FLTRVH04	FLTRV218	-	-	-	17882-1	FLT12230000	FLTRVH01	FLTRV223	-	-	Yes
010021726	FLT71050001	FLTRVH07	FLTRV105	-	FLTRVS01	-	17891-1	FLT22230000	FLTRVH02	FLTRV223	-	-	-
010021792	FLT041010000	FLTRVH04	FLTRV101	-	-	-	17898-1	FLT41120002	FLTRVH04	FLTRV112	-	FLTRVS02	-
010022047	FLT42040000	FLTRVH04	FLTRV204	-	-	-	17906-1	FLT21060002	FLTRVH02	FLTRV106	-	FLTRVS02	-
010022048	FLT52040000	FLTRVH05	FLTRV204	-	-	-	17913-1	FLT41120002	FLTRVH04	FLTRV112	-	FLTRVS02	-
010022049	FLT42060000	FLTRVH04	FLTRV206	-	-	-	17913-2	FLT41120002	FLTRVH04	FLTRV112	-	FLTRVS02	-
010022050	FLT52190000	FLTRVH05	FLTRV219	-	-	-	17915-1	FLT72210000	FLTRVH07	FLTRV221	-	-	-
010022367	FLT041010000	FLTRVH04	FLTRV101	-	-	-	17916-1	FLT72010101	FLTRVH07	FLTRV201	FLTRVP01	FLTRVS01	-
010022541	FLT42190000	FLTRVH04	FLTRV219	-	-	-	17926-3	FLT11060002	FLTRVH01	FLTRV106	-	FLTRVS02	-
010023060	FLT12220000	FLTRVH01	FLTRV222	-	-	-	17939-1	FLT52010100	FLTRVH05	FLTRV201	FLTRVP01	-	-
010023312	FLT12030103	FLTRVH01	FLTRV203	FLTRVP01	FLTRVS03	-	17939-2	FLT52010100	FLTRVH05	FLTRV201	FLTRVP01	-	-
010023319	FLT42020100	FLTRVH04	FLTRV202	FLTRVP01	-	-	17969-1	FLT42200500	FLTRVH04	FLTRV220	FLTRVP05	-	-
010023323	FLT22030103	FLTRVH02	FLTRV203	FLTRVP01	FLTRVS03	-	17993-1	FLT52010100	FLTRVH05	FLTRV201	FLTRVP01	-	-
010023346	FLT12150000	FLTRVH01	FLTRV215	-	-	-	18019-1	FLT12231200	FLTRVH01	FLTRV223	FLTRVP12	-	-
010023364	FLT031110000	FLTRVH03	FLTRV111	-	-	-	18049-1	FLT42200500	FLTRVH04	FLTRV220	FLTRVP05	-	-
010023365	FLT52020100	FLTRVH05	FLTRV202	FLTRVP01	-	-	18088-1	FLT41120002	FLTRVH04	FLTRV112	-	FLTRVS02	-
010023474	FLT62010100	FLTRVH06	FLTRV201	FLTRVP01	-	-	18088-2	FLT41120002	FLTRVH04	FLTRV112	-	FLTRVS02	-
010023513	FLT52010100	FLTRVH05	FLTRV201	FLTRVP01	-	-	18092-1	FLT22230000	FLTRVH02	FLTRV223	-	-	-
010023608	FLT52050000	FLTRVH05	FLTRV205	-	-	-	18100-1	FLT11060002	FLTRVH01	FLTRV106	-	FLTRVS02	-
010023757	FLT72010100	FLTRVH07	FLTRV201	FLTRVP01	-	-	18105-1	FLT72010101	FLTRVH07	FLTRV201	FLTRVP01	FLTRVS01	-
010023768	FLT72010100	FLTRVH07	FLTRV201	FLTRVP01	-	-	18115-1	FLT22030000	FLTRVH02	FLTRV203	-	-	-
010023963	FLT071040003	FLTRVH07	FLTRV104	-	FLTRVS03	-	18117-2	FLT52290003	FLTRVH05	FLTRV229	-	FLTRVS03	-
010023971	FLT42180000	FLTRVH04	FLTRV218	-	-	-	18164-1	FLT41120002	FLTRVH04	FLTRV112	-	FLTRVS02	-
010024281	FLT41030000	FLTRVH04	FLTRV103	-	-	-	18168-1	FLT52100000	FLTRVH05	FLTRV210	-	-	-
010024706	FLT41030000	FLTRVH04	FLTRV103	-	-	-	18192-1	FLT11060002	FLTRVH01	FLTRV106	-	FLTRVS02	-
1210-09155-01	FLT021090000	FLTRVH02	FLTRV109	-	-	-	18197-1	FLT41120002	FLTRVH04	FLTRV112	-	FLTRVS02	-
1210-09156-02	FLT031110000	FLTRVH03	FLTRV111	-	-	-	18225-1	FLT52200500	FLTRVH05	FLTRV220	FLTRVP05	-	-
1210-09157-01	FLT41050000	FLTRVH04	FLTRV105	-	-	-	18247-1	FLT52010101	FLTRVH05	FLTRV201	FLTRVP01	FLTRVS01	-
1210-09157-02	FLT031110000	FLTRVH03	FLTRV111	-	-	-	18284-1	FLT71120002	FLTRVH07	FLTRV112	-	FLTRVS02	-
1210-09157-03	FLT021090000	FLTRVH02	FLTRV109	-	-	-	18284-2	FLT71120002	FLTRVH07	FLTRV112	-	FLTRVS02	-
1210-09157-05	FLT031110000	FLTRVH03	FLTRV111	-	-	-	18299-1	FLT41120002	FLTRVH04	FLTRV112	-	FLTRVS02	-
1210-09167-02	FLT21070000	FLTRVH02	FLTRV107	-	-	-	18324-1	FLT72010100	FLTRVH07	FLTRV201	FLTRVP01	-	-
1210-09167-03	FLT021090000	FLTRVH02	FLTRV109	-	-	-	18325-1	FLT42020000	FLTRVH04	FLTRV202	-	-	-
1210-09167-54	FLT21060000	FLTRVH02	FLTRV106	-	-	-	18327-2	FLT72020100	FLTRVH07	FLTRV201	FLTRVP01	-	-
1210-09168-03	FLT061050000	FLTRVH06	FLTRV105	-	-	-	18359-1	FLT22230000	FLTRVH02	FLTRV223	-	-	-
1210-09168-05	FLT41050000	FLTRVH04	FLTRV105	-	-	-	18367-1	FLT42010000	FLTRVH04	FLTRV201	-	-	-
1210-09168-10	FLT42040000	FLTRVH04	FLTRV204	-	-	-	18400-1	FLT22030000	FLTRVH02	FLTRV203	-	-	-
							18421-1	FLT41120002	FLTRVH04	FLTRV112	-	FLTRVS02	-

Cross Reference Viscous Fan Clutches

Mfr. Part #	Fleetrite Part #	Head	Bracket	Pilot Adapter	Special	New Fan Required
18424-1	FLT41120002	FLTRVH04	FLTRV112	-	FLTRVS02	-
18424-2	FLT41120002	FLTRVH04	FLTRV112	-	FLTRVS02	-
18425-1	FLT41120002	FLTRVH04	FLTRV112	-	FLTRVS02	-
18426-1	FLT41120002	FLTRVH04	FLTRV112	-	FLTRVS02	-
18426-2	FLT41120002	FLTRVH04	FLTRV112	-	FLTRVS02	-
18441-1	FLT62020000	FLTRVH06	FLTRV202	-	-	-
18441-2	FLT62020000	FLTRVH06	FLTRV202	-	-	-
18441-3	FLT62020000	FLTRVH06	FLTRV202	-	-	-
18467-1	FLT42010100	FLTRVH04	FLTRV201	FLTRVP01	-	-
18521-1	FLT11060000	FLTRVH01	FLTRV106	-	-	-
18522-1	FLT11060000	FLTRVH01	FLTRV106	-	-	-
18523-1	FLT42090000	FLTRVH04	FLTRV209	-	-	-
18627-1	FLT41120002	FLTRVH04	FLTRV112	-	FLTRVS02	-
18627-2	FLT41120002	FLTRVH04	FLTRV112	-	FLTRVS02	-
18645-1	FLT12170900	FLTRVH01	FLTRV217	FLTRVP09	-	-
18672-1	FLT42010000	FLTRVH04	FLTRV201	-	-	-
18676-1	FLT42020000	FLTRVH04	FLTRV202	-	-	-
18682-2	FLT21060002	FLTRVH02	FLTRV106	-	FLTRVS02	-
18753-1	FLT42010100	FLTRVH04	FLTRV201	FLTRVP01	-	-
18783-1	FLT41120002	FLTRVH04	FLTRV112	-	FLTRVS02	-
18784-1	FLT41120002	FLTRVH04	FLTRV112	-	FLTRVS02	-
18786-1	FLT41140000	FLTRVH04	FLTRV114	-	-	-
18801-1	FLT22250000	FLTRVH02	FLTRV225	-	-	-
18806-1	FLT22170000	FLTRVH02	FLTRV217	-	-	-
18838-2	FLT11060000	FLTRVH01	FLTRV106	-	-	-
18890-1	FLT21060002	FLTRVH02	FLTRV106	-	FLTRVS02	-
18891-2	FLT72110001	FLTRVH07	FLTRV211	-	FLTRVS01	-
18898-1	FLT72100001	FLTRVH07	FLTRV210	-	FLTRVS01	-
18937-1	FLT71120002	FLTRVH07	FLTRV112	-	FLTRVS02	-
18963-1	FLT41120002	FLTRVH04	FLTRV112	-	FLTRVS02	-
18968-1	FLT71130000	FLTRVH07	FLTRV113	-	-	-
19005-1	FLT42010100	FLTRVH04	FLTRV201	FLTRVP01	-	-
19025-1	FLT11060002	FLTRVH01	FLTRV106	-	FLTRVS02	-
19026-2	FLT41120002	FLTRVH04	FLTRV112	-	FLTRVS02	-
19033-1	FLT72010100	FLTRVH07	FLTRV201	FLTRVP01	-	-
19034-1	FLT72010100	FLTRVH07	FLTRV201	FLTRVP01	-	-
19043-1	FLT72010101	FLTRVH07	FLTRV201	FLTRVP01	FLTRVS01	-
19044-1	FLT72090001	FLTRVH07	FLTRV209	-	FLTRVS01	-
19047-1	FLT72010101	FLTRVH07	FLTRV201	FLTRVP01	FLTRVS01	-
19061-1	FLT72010100	FLTRVH07	FLTRV201	FLTRVP01	-	-
19062-1	FLT72010100	FLTRVH07	FLTRV201	FLTRVP01	-	-
19067-1	FLT72010101	FLTRVH07	FLTRV201	FLTRVP01	FLTRVS01	-
19068-1	FLT72010101	FLTRVH07	FLTRV201	FLTRVP01	FLTRVS01	-
19069-1	FLT72010101	FLTRVH07	FLTRV201	FLTRVP01	FLTRVS01	-
19089-1	FLT62010101	FLTRVH06	FLTRV201	FLTRVP01	FLTRVS01	-
19090-1	FLT72010101	FLTRVH07	FLTRV201	FLTRVP01	FLTRVS01	-
19091-1	FLT52010101	FLTRVH05	FLTRV201	FLTRVP01	FLTRVS01	-
19092-1	FLT52010101	FLTRVH05	FLTRV201	FLTRVP01	FLTRVS01	-
19093-1	FLT62010101	FLTRVH06	FLTRV201	FLTRVP01	FLTRVS01	-
19104-1	FLT22030000	FLTRVH02	FLTRV203	-	-	-
19105-1	FLT52010101	FLTRVH05	FLTRV201	FLTRVP01	FLTRVS01	-
19106-1	FLT62010101	FLTRVH06	FLTRV201	FLTRVP01	FLTRVS01	-
19137-1	FLT71130001	FLTRVH07	FLTRV113	-	FLTRVS01	-
19170-1	FLT62020003	FLTRVH06	FLTRV202	-	FLTRVS03	-
19179-1	FLT21060002	FLTRVH02	FLTRV106	-	FLTRVS02	-
19180-1	FLT42130900	FLTRVH04	FLTRV213	FLTRVP09	-	-
EV-16233-2	FLT72010100	FLTRVH07	FLTRV201	FLTRVP01	-	-
EV-16650-2	FLT72011000	FLTRVH07	FLTRV201	FLTRVP10	-	-
EV-16686-1	FLT22030000	FLTRVH02	FLTRV203	-	-	-
EV-16686-2	FLT22030000	FLTRVH02	FLTRV203	-	-	-
EV-16784-3	FLT72010101	FLTRVH07	FLTRV201	FLTRVP01	FLTRVS01	-
EV-17038-1	FLT72010101	FLTRVH07	FLTRV201	FLTRVP01	FLTRVS01	-
EV-17235-1	FLT52010100	FLTRVH05	FLTRV201	FLTRVP01	-	-
EV-17284-1	FLT42010100	FLTRVH04	FLTRV201	FLTRVP01	-	-
EV-17310-1	FLT32261500	FLTRVH03	FLTRV226	FLTRVP15	-	-
EV-17390-1	FLT72010101	FLTRVH07	FLTRV201	FLTRVP01	FLTRVS01	-
EV-17398-1	FLT12030800	FLTRVH01	FLTRV203	FLTRVP08	-	-
EV-17405-1	FLT22240203	FLTRVH02	FLTRV224	FLTRVP02	FLTRVS03	-
EV-17449-1	FLT22081303	FLTRVH02	FLTRV208	FLTRVP13	FLTRVS03	Yes
EV-17456-1	FLT42010000	FLTRVH04	FLTRV201	-	-	-
EV-17482-1	FLT22030100	FLTRVH02	FLTRV203	FLTRVP01	-	Yes
EV-17497-1	FLT22150700	FLTRVH02	FLTRV215	FLTRVP07	-	-
EV-17539-1	FLT62010100	FLTRVH06	FLTRV201	FLTRVP01	-	-
EV-17545-1	FLT22030000	FLTRVH02	FLTRV203	-	-	-
EV-17562-1	FLT22230000	FLTRVH02	FLTRV223	-	-	Yes

Mfr. Part #	Fleetrite Part #	Head	Bracket	Pilot Adapter	Special	New Fan Required
EV-17581-1	FLT72010100	FLTRVH07	FLTRV201	FLTRVP01	-	-
EV-17585-1	FLT52100000	FLTRVH05	FLTRV210	-	-	-
EV-17595-1	FLT72010100	FLTRVH07	FLTRV201	FLTRVP01	-	-
EV-17637-2	FLT61160002	FLTRVH06	FLTRV116	-	FLTRVS02	-
EV-17650-1	FLT22030000	FLTRVH02	FLTRV203	-	-	-
EV-17657-1	FLT72010100	FLTRVH07	FLTRV201	FLTRVP01	-	-
EV-17671-1	FLT12030000	FLTRVH01	FLTRV203	-	-	-
EV-17708-1	FLT42010000	FLTRVH04	FLTRV201	-	-	-
EV-17708-2	FLT42010000	FLTRVH04	FLTRV201	-	-	-
EV-17713-1	FLT52020003	FLTRVH05	FLTRV202	-	FLTRVS03	-
EV-17740-3	FLT11060002	FLTRVH01	FLTRV106	-	FLTRVS02	Yes
EV-17740-4	FLT11060002	FLTRVH01	FLTRV106	-	FLTRVS02	Yes
EV-17856-1	FLT42010101	FLTRVH04	FLTRV201	FLTRVP01	FLTRVS01	-
EV-17858-1	FLT32260903	FLTRVH03	FLTRV226	FLTRVP09	FLTRVS03	-
EV-17862-1	FLT72010100	FLTRVH07	FLTRV201	FLTRVP01	-	-
EV-17866-1	FLT52200500	FLTRVH05	FLTRV220	FLTRVP05	-	-
EV-17881-1	FLT12230000	FLTRVH01	FLTRV223	-	-	-
EV-17882-1	FLT12230000	FLTRVH01	FLTRV223	-	-	Yes
EV-17891-1	FLT22230000	FLTRVH02	FLTRV223	-	-	-
EV-17898-1	FLT41120002	FLTRVH04	FLTRV112	-	FLTRVS02	-
EV-17906-1	FLT21060002	FLTRVH02	FLTRV106	-	FLTRVS02	-
EV-17913-1	FLT41120002	FLTRVH04	FLTRV112	-	FLTRVS02	-
EV-17913-2	FLT41120002	FLTRVH04	FLTRV112	-	FLTRVS02	-
EV-17915-1	FLT72210000	FLTRVH07	FLTRV221	-	-	-
EV-17916-1	FLT72010101	FLTRVH07	FLTRV201	FLTRVP01	FLTRVS01	-
EV-17926-3	FLT11060002	FLTRVH01	FLTRV106	-	FLTRVS02	-
EV-17939-1	FLT52010100	FLTRVH05	FLTRV201	FLTRVP01	-	-
EV-17939-2	FLT52010100	FLTRVH05	FLTRV201	FLTRVP01	-	-
EV-17969-1	FLT42200500	FLTRVH04	FLTRV220	FLTRVP05	-	-
EV-17993-1	FLT52010100	FLTRVH05	FLTRV201	FLTRVP01	-	-
EV-18019-1	FLT12231200	FLTRVH01	FLTRV223	FLTRVP12	-	-
EV-18049-1	FLT42200500	FLTRVH04	FLTRV220	FLTRVP05	-	-
EV-18088-1	FLT41120002	FLTRVH04	FLTRV112	-	FLTRVS02	-
EV-18088-2	FLT41120002	FLTRVH04	FLTRV112	-	FLTRVS02	-
EV-18092-1	FLT22230000	FLTRVH02	FLTRV223	-	-	-
EV-18100-1	FLT11060002	FLTRVH01	FLTRV106	-	FLTRVS02	-
EV-18105-1	FLT72010101	FLTRVH07	FLTRV201	FLTRVP01	FLTRVS01	-
EV-18115-1	FLT22030000	FLTRVH02	FLTRV203	-	-	-
EV-18117-2	FLT52290003	FLTRVH05	FLTRV229	-	FLTRVS03	-
EV-18164-1	FLT41120002	FLTRVH04	FLTRV112	-	FLTRVS02	-
EV-18168-1	FLT52100000	FLTRVH05	FLTRV210	-	-	-
EV-18192-1	FLT11060002	FLTRVH01	FLTRV106	-	FLTRVS02	-
EV-18197-1	FLT41120002	FLTRVH04	FLTRV112	-	FLTRVS02	-
EV-18225-1	FLT52200500	FLTRVH05	FLTRV220	FLTRVP05	-	-
EV-18247-1	FLT52010101	FLTRVH05	FLTRV201	FLTRVP01	FLTRVS01	-
EV-18284-1	FLT71120002	FLTRVH07	FLTRV112	-	FLTRVS02	-
EV-18284-2	FLT71120002	FLTRVH07	FLTRV112	-	FLTRVS02	-
EV-18299-1	FLT41120002	FLTRVH04	FLTRV112	-	FLTRVS02	-
EV-18324-1	FLT72010100	FLTRVH07	FLTRV201	FLTRVP01	-	-
EV-18325-1	FLT42020000	FLTRVH04	FLTRV202	-	-	-
EV-18327-2	FLT72020100	FLTRVH07	FLTRV202	FLTRVP01	-	-
EV-18359-1	FLT22230000	FLTRVH02	FLTRV223	-	-	-
EV-18367-1	FLT42010000	FLTRVH04	FLTRV201	-	-	-
EV-18400-1	FLT22030000	FLTRVH02	FLTRV203	-	-	-
EV-18421-1	FLT41120002	FLTRVH04	FLTRV112	-	FLTRVS02	-
EV-18424-1	FLT41120002	FLTRVH04	FLTRV112	-	FLTRVS02	-
EV-18424-2	FLT41120002	FLTRVH04	FLTRV112	-	FLTRVS02	-
EV-18425-1	FLT41120002	FLTRVH04	FLTRV112	-	FLTRVS02	-
EV-18426-1	FLT41120002	FLTRVH04	FLTRV112	-	FLTRVS02	-
EV-18426-2	FLT41120002	FLTRVH04	FLTRV112	-	FLTRVS02	-
EV-18441-1	FLT62020000	FLTRVH06	FLTRV202	-	-	-
EV-18441-2	FLT62020000	FLTRVH06	FLTRV202	-	-	-
EV-18441-3	FLT62020000	FLTRVH06	FLTRV202	-	-	-
EV-18467-1	FLT42010100	FLTRVH04	FLTRV201	FLTRVP01	-	-
EV-18521-1	FLT11060000	FLTRVH01	FLTRV106	-	-	-
EV-18522-1	FLT11060000	FLTRVH01	FLTRV106	-	-	-
EV-18523-1	FLT42090000	FLTRVH04	FLTRV209	-	-	-
EV-18627-1	FLT41120002	FLTRVH04	FLTRV112	-	FLTRVS02	-
EV-18627-2	FLT41120002	FLTRVH04	FLTRV112	-	FLTRVS02	-
EV-18645-1	FLT12170900	FLTRVH01	FLTRV217	FLTRVP09	-	-
EV-18672-1	FLT42010000	FLTRVH04	FLTRV201	-	-	-
EV-18676-1	FLT42020000	FLTRVH04	FLTRV202	-	-	-
EV-18682-2	FLT21060002	FLTRVH02	FLTRV106	-	FLTRVS02	-
EV-18753-1	FLT42010100	FLTRVH04	FLTRV201	FLTRVP01	-	-
EV-18783-1	FLT41120002	FLTRVH04	FLTRV112	-	FLTRVS02	-

Mfr. Part #	Fleetrite Part #	Head	Bracket	Pilot Adapter	Special	New Fan Required
EV-18784-1	FLT41120002	FLTRVH04	FLTRV112	-	FLTRVS02	-
EV-18786-1	FLT41140000	FLTRVH04	FLTRV114	-	-	-
EV-18801-1	FLT22250000	FLTRVH02	FLTRV225	-	-	-
EV-18806-1	FLT22170000	FLTRVH02	FLTRV217	-	-	-
EV-18838-2	FLT11060000	FLTRVH01	FLTRV106	-	-	-
EV-18890-1	FLT21060002	FLTRVH02	FLTRV106	-	FLTRVS02	-
EV-18891-2	FLT72110001	FLTRVH07	FLTRV211	-	FLTRVS01	-
EV-18898-1	FLT72100001	FLTRVH07	FLTRV210	-	FLTRVS01	-
EV-18937-1	FLT71120002	FLTRVH07	FLTRV112	-	FLTRVS02	-
EV-18963-1	FLT41120002	FLTRVH04	FLTRV112	-	FLTRVS02	-
EV-18968-1	FLT71130000	FLTRVH07	FLTRV113	-	-	-
EV-19005-1	FLT42010100	FLTRVH04	FLTRV201	FLTRVP01	-	-
EV-19025-1	FLT11060002	FLTRVH01	FLTRV106	-	FLTRVS02	-
EV-19026-2	FLT41120002	FLTRVH04	FLTRV112	-	FLTRVS02	-
EV-19033-1	FLT72010100	FLTRVH07	FLTRV201	FLTRVP01	-	-
EV-19034-1	FLT72010100	FLTRVH07	FLTRV201	FLTRVP01	-	-
EV-19043-1	FLT72010101	FLTRVH07	FLTRV201	FLTRVP01	FLTRVS01	-
EV-19044-1	FLT72090001	FLTRVH07	FLTRV209	-	FLTRVS01	-
EV-19047-1	FLT72010101	FLTRVH07	FLTRV201	FLTRVP01	FLTRVS01	-
EV-19061-1	FLT72010100	FLTRVH07	FLTRV201	FLTRVP01	-	-
EV-19062-1	FLT72010100	FLTRVH07	FLTRV201	FLTRVP01	-	-
EV-19067-1	FLT72010101	FLTRVH07	FLTRV201	FLTRVP01	FLTRVS01	-
EV-19068-1	FLT72010101	FLTRVH07	FLTRV201	FLTRVP01	FLTRVS01	-
EV-19069-1	FLT72010101	FLTRVH07	FLTRV201	FLTRVP01	FLTRVS01	-
EV-19089-1	FLT62010101	FLTRVH06	FLTRV201	FLTRVP01	FLTRVS01	-
EV-19090-1	FLT72010101	FLTRVH07	FLTRV201	FLTRVP01	FLTRVS01	-
EV-19091-1	FLT52010101	FLTRVH05	FLTRV201	FLTRVP01	FLTRVS01	-
EV-19092-1	FLT52010101	FLTRVH05	FLTRV201	FLTRVP01	FLTRVS01	-
EV-19093-1	FLT62010101	FLTRVH06	FLTRV201	FLTRVP01	FLTRVS01	-
EV-19104-1	FLT22030000	FLTRVH02	FLTRV203	-	-	-
EV-19105-1	FLT52010101	FLTRVH05	FLTRV201	FLTRVP01	FLTRVS01	-
EV-19106-1	FLT62010101	FLTRVH06	FLTRV201	FLTRVP01	FLTRVS01	-
EV-19137-1	FLT71130001	FLTRVH07	FLTRV113	-	FLTRVS01	-
EV-19170-1	FLT62020003	FLTRVH06	FLTRV202	-	FLTRVS03	-
EV-19179-1	FLT21060002	FLTRVH02	FLTRV106	-	FLTRVS02	-
EV-19180-1	FLT42130900	FLTRVH04	FLTRV213	FLTRVP09	-	-
EV-6084-T	FLT72010000	FLTRVH07	FLTRV201	-	-	-
FORD						
1C4Z-8A616-BA	FLT11060002	FLTRVH01	FLTRV106	-	FLTRVS02	-
1C4Z-8A616-BA	FLT11060002	FLTRVH01	FLTRV106	-	FLTRVS02	-
D7HT-8A616-AEC	FLT22160000	FLTRVH02	FLTRV216	-	-	-
D7HZ-8A616-D	FLT22160000	FLTRVH02	FLTRV216	-	-	-
D7HZ-8A616-G	FLT22160000	FLTRVH02	FLTRV216	-	-	-
D7HZ-8A616-P	FLT22160000	FLTRVH02	FLTRV216	-	-	-
D8HS-8A616-CA	FLT72011101	FLTRVH07	FLTRV201	FLTRVP11	FLTRVS01	-
D9HT-8A616-BD	FLT22170000	FLTRVH02	FLTRV217	-	-	-
D9HZ-8A616-C	FLT22170000	FLTRVH02	FLTRV217	-	-	-
D9HZ-8A616-H	FLT22170000	FLTRVH02	FLTRV217	-	-	-
E1HT-8A616-AA	FLT22171400	FLTRVH02	FLTRV217	FLTRVP14	-	-
E1HZ-8A616-A	FLT22171400	FLTRVH02	FLTRV217	FLTRVP14	-	-
E1HZ-8A616-G	FLT22171400	FLTRVH02	FLTRV217	FLTRVP14	-	-
E2HS-8A616-AA	FLT52010001	FLTRVH05	FLTRV201	-	FLTRVS01	-
E2HS-8A616-BA	FLT52010001	FLTRVH05	FLTRV201	-	FLTRVS01	-
E2HT-8A616-CA	FLT22170000	FLTRVH02	FLTRV217	-	-	-
E3HT-8A616-EC	FLT12030800	FLTRVH01	FLTRV203	FLTRVP08	-	-
E3HZ-8A616-A	FLT12030800	FLTRVH01	FLTRV203	FLTRVP08	-	-
E3HZ-8A616-G	FLT12030800	FLTRVH01	FLTRV203	FLTRVP08	-	-
E3TZ-8A616-E	FLT11200002	FLTRVH01	FLTRV120	-	FLTRVS02	-
E4HS-8A616-CA	FLT12030800	FLTRVH01	FLTRV203	FLTRVP08	-	-
E5HS-8A616-BA	FLT52010001	FLTRVH05	FLTRV201	-	FLTRVS01	-
E5HS-8A616-DA	FLT72010100	FLTRVH07	FLTRV201	FLTRVP01	-	-
E5HS-8A627-DA	FLT72010100	FLTRVH07	FLTRV201	FLTRVP01	-	-
E5HZ-8A616-A	FLT21220000	FLTRVH02	FLTRV122	-	-	-
E5HZ-8A616-B	FLT21220000	FLTRVH02	FLTRV122	-	-	-
E5TA-8A616-SA	FLT11200002	FLTRVH01	FLTRV120	-	FLTRVS02	-
E5TZ-8A616-C	FLT11200002	FLTRVH01	FLTRV120	-	FLTRVS02	-
E6HS-8A616-AA	FLT52010001	FLTRVH05	FLTRV201	-	FLTRVS01	-
E6HT-8A616-GA	FLT11200002	FLTRVH01	FLTRV120	-	FLTRVS02	-
E6HZ-8A616-D	FLT41210000	FLTRVH04	FLTRV121	-	-	-
E6TA-8A616-DA	FLT11200002	FLTRVH01	FLTRV120	-	FLTRVS02	-
E6TZ-8A616-A	FLT11200002	FLTRVH01	FLTRV120	-	FLTRVS02	-
E7HT-8A616-MA	FLT22171400	FLTRVH02	FLTRV217	FLTRVP14	-	-
E7HT-8A616-RA	FLT12030800	FLTRVH01	FLTRV203	FLTRVP08	-	-
E7HT-8A616-SA	FLT21220000	FLTRVH02	FLTRV122	-	-	-
E8HT-8A616-IA	FLT52120000	FLTRVH05	FLTRV212	-	-	-

Mfr. Part #	Fleetrite Part #	Head	Bracket	Pilot Adapter	Special	New Fan Required
E8HT-8A616-LA	FLT52120000	FLTRVH05	FLTRV212	-	-	-
E8HT-8A616-NA	FLT52100000	FLTRVH05	FLTRV210	-	-	-
E8HT-8A616-SA	FLT41210000	FLTRVH04	FLTRV121	-	-	-
E8HT-8A616-TA	FLT52120000	FLTRVH05	FLTRV212	-	-	-
E8HZ-8A616-A	FLT72020100	FLTRVH07	FLTRV202	FLTRVP01	-	-
E8HZ-8A616-K	FLT52120000	FLTRVH05	FLTRV212	-	-	-
E8HZ-8A616-L	FLT41210000	FLTRVH04	FLTRV121	-	-	-
E8HZ-8A616-M	FLT52120000	FLTRVH05	FLTRV212	-	-	-
E8TA-8A616-PA	FLT11200002	FLTRVH01	FLTRV120	-	FLTRVS02	-
E9HZ-8A616-A	FLT52100000	FLTRVH05	FLTRV210	-	-	-
E9HZ-8A616-B	FLT52011601	FLTRVH05	FLTRV201	FLTRVP16	FLTRVS01	-
E9TA-8A616-EA	FLT11200002	FLTRVH01	FLTRV120	-	FLTRVS02	-
E9TZ-8A616-A	FLT11200002	FLTRVH01	FLTRV120	-	FLTRVS02	-
E9TZ-8A616-G	FLT11200002	FLTRVH01	FLTRV120	-	FLTRVS02	-
F0HS-8A616-BA	FLT52011601	FLTRVH05	FLTRV201	FLTRVP16	FLTRVS01	-
F0HS-8A616-CA3	FLT52090001	FLTRVH05	FLTRV209	-	FLTRVS01	-
F0HS-8A616-DA	FLT52090001	FLTRVH05	FLTRV209	-	FLTRVS01	-
F0HT-8A616-F	FLT22150700	FLTRVH02	FLTRV215	FLTRVP07	-	-
F1HT-8A616-DA	FLT61160002	FLTRVH06	FLTRV116	-	FLTRVS02	-
F1HT-8A616-EA	FLT11060002	FLTRVH01	FLTRV106	-	FLTRVS02	Yes
F3HT-8A616-BA	FLT41120002	FLTRVH04	FLTRV112	-	FLTRVS02	-
F3HT-BA	FLT41120002	FLTRVH04	FLTRV112	-	FLTRVS02	-
F3HZ-8A616-B	FLT41120002	FLTRVH04	FLTRV112	-	FLTRVS02	-
F3TA-8A616-GA	FLT11200002	FLTRVH01	FLTRV120	-	FLTRVS02	-
F5TA-8A616-KB	FLT31100002	FLTRVH03	FLTRV110	-	FLTRVS02	-
F5TZ-8A616-KB	FLT31100002	FLTRVH03	FLTRV110	-	FLTRVS02	-
F7HS-8A616-AA	FLT42090000	FLTRVH04	FLTRV209	-	-	-
F7HT-8A616-BA	FLT11060002	FLTRVH01	FLTRV106	-	FLTRVS02	-
F7HT-8A616-DA	FLT11060002	FLTRVH01	FLTRV106	-	FLTRVS02	Yes
F8HT-8A616-FA	FLT41210000	FLTRVH04	FLTRV121	-	-	-
F8HT-8A616-LA	FLT52120000	FLTRVH05	FLTRV212	-	-	-
IC44-8A616-BA	FLT11060002	FLTRVH01	FLTRV106	-	FLTRVS02	-
IC44-8A616-CB	FLT41120002	FLTRVH04	FLTRV112	-	FLTRVS02	-
XC45-8A616-AA	FLT12170900	FLTRVH01	FLTRV217	FLTRVP09	-	-
FREIGHTLINER						
05-12225-000	FLT72010100	FLTRVH07	FLTRV201	FLTRVP01	-	-
680-200-01-26	FLT12230000	FLTRVH01	FLTRV223	-	-	-
680-200-02-26	FLT12230000	FLTRVH01	FLTRV223	-	-	Yes
GM						
15044771	FLT41140000	FLTRVH04	FLTRV114	-	-	-
15504174	FLT22030300	FLTRVH02	FLTRV203	FLTRVP03	-	-
15679381	FLT41120002	FLTRVH04	FLTRV112	-	FLTRVS02	-
15684550	FLT21060002	FLTRVH02	FLTRV106	-	FLTRVS02	-
15718025	FLT41120002	FLTRVH04	FLTRV112	-	FLTRVS02	-
15815058	FLT41120002	FLTRVH04	FLTRV112	-	FLTRVS02	-
15990495	FLT11060002	FLTRVH01	FLTRV106	-	FLTRVS02	-
15990496	FLT41120002	FLTRVH04	FLTRV112	-	FLTRVS02	-
15995659	FLT41120002	FLTRVH04	FLTRV112	-	FLTRVS02	-
HORTON						
9802000	FLT22230000	FLTRVH02	FLTRV223	-	-	-
9802001	FLT12230000	FLTRVH01	FLTRV223	-	-	-
9802002	FLT22030000	FLTRVH02	FLTRV203	-	-	-
9802003	FLT11060002	FLTRVH01	FLTRV106	-	FLTRVS02	-
9802004	FLT41050000	FLTRVH04	FLTRV105	-	-	-
9802005	FLT41050000	FLTRVH04	FLTRV105	-	-	-
9802008	FLT031110000	FLTRVH03	FLTRV111	-	-	-
9802009	FLT42130900	FLTRVH04	FLTRV213	FLTRVP09	-	-
9802012	FLT41050000	FLTRVH04	FLTRV105	-	-	-
9802013	FLT41050000	FLTRVH04	FLTRV105	-	-	-
9802015	FLT061050000	FLTRVH06	FLTRV105	-	-	-
9803000	FLT42200500	FLTRVH04	FLTRV220	FLTRVP05	-	-
9803002	FLT41050000	FLTRVH04	FLTRV105	-	-	-
9902000	FLT22230000	FLTRVH02	FLTRV223	-	-	-
9902001	FLT12230000	FLTRVH01	FLTRV223	-	-	-
9902002	FLT22030000	FLTRVH02	FLTRV203	-	-	-
9902003	FLT11060002	FLTRVH01	FLTRV106	-	FLTRVS02	-
9902004	FLT41050000	FLTRVH04	FLTRV105	-	-	-
9902005	FLT41050000	FLTRVH04	FLTRV105	-	-	-
9902007	FLT031110000	FLTRVH03	FLTRV111	-	-	-
9902008	FLT031110000	FLTRVH03	FLTRV111	-	-	-
9902009	FLT42130900	FLTRVH04	FLTRV213	FLTRVP09	-	-
9902012	FLT41050000	FLTRVH04	FLTRV105	-	-	-
9902013	FLT41050000	FLTRVH04	FLTRV105	-	-	-
9902015	FLT061050000	FLTRVH06	FLTRV105	-	-	-
9903000	FLT42200500	FLTRVH04	FLTRV220	FLTRVP05	-	-

Mfr. Part #	Fleetrite Part #	Head	Bracket	Pilot Adapter	Special	New Fan Required
9903001	FLT41050000	FLTRVH04	FLTRV105	-	-	-
9903002	FLT41050000	FLTRVH04	FLTRV105	-	-	-
INTERNATIONAL						
0488330C1	FLT52020300	FLTRVH05	FLTRV202	FLTRVP03	-	-
0489271C1	FLT22240203	FLTRVH02	FLTRV224	FLTRVP02	FLTRVS03	Yes
0494344C1	FLT12070200	FLTRVH01	FLTRV207	FLTRVP02	-	Yes
0503192C91	FLT52010100	FLTRVH05	FLTRV201	FLTRVP01	-	-
0504909C1	FLT22030100	FLTRVH02	FLTRV203	FLTRVP01	-	-
0504910C1	FLT22030100	FLTRVH02	FLTRV203	FLTRVP01	-	-
0507271C2	FLT52010101	FLTRVH05	FLTRV201	FLTRVP01	FLTRVS01	-
0534319C1	FLT72020100	FLTRVH07	FLTRV202	FLTRVP01	-	-
0537481C1	FLT22030100	FLTRVH02	FLTRV203	FLTRVP01	-	-
0557146C91	FLT52010100	FLTRVH05	FLTRV201	FLTRVP01	-	-
0587655C1	FLT22030100	FLTRVH02	FLTRV203	FLTRVP01	-	-
0587656C1	FLT22030100	FLTRVH02	FLTRV203	FLTRVP01	-	-
0996121C93	FLT22081303	FLTRVH02	FLTRV208	FLTRVP13	FLTRVS03	Yes
0996121C93	FLT22081303	FLTRVH02	FLTRV208	FLTRVP13	FLTRVS03	Yes
0999643C91	FLT22081303	FLTRVH02	FLTRV208	FLTRVP13	FLTRVS03	Yes
1606005C92	FLT22150000	FLTRVH02	FLTRV215	-	-	-
1607003C91	FLT52010100	FLTRVH05	FLTRV201	FLTRVP01	-	-
1609989C91	FLT22030100	FLTRVH02	FLTRV203	FLTRVP01	-	-
1612269C1	FLT52010101	FLTRVH05	FLTRV201	FLTRVP01	FLTRVS01	-
1612269C2	FLT52010101	FLTRVH05	FLTRV201	FLTRVP01	FLTRVS01	-
1613085C91	FLT52010100	FLTRVH05	FLTRV201	FLTRVP01	-	-
1614086C1	FLT22240203	FLTRVH02	FLTRV224	FLTRVP02	FLTRVS03	Yes
1614086C2	FLT22240203	FLTRVH02	FLTRV224	FLTRVP02	FLTRVS03	Yes
1614087C1	FLT22240203	FLTRVH02	FLTRV224	FLTRVP02	FLTRVS03	Yes
1614914C1	FLT12070200	FLTRVH01	FLTRV207	FLTRVP02	-	Yes
1614914C2	FLT12070200	FLTRVH01	FLTRV207	FLTRVP02	-	Yes
1651724C1	FLT42020100	FLTRVH04	FLTRV202	FLTRVP01	-	-
1652591C1	FLT42020100	FLTRVH04	FLTRV202	FLTRVP01	-	-
1654584C1	FLT22150000	FLTRVH02	FLTRV215	-	-	-
1654586C1	FLT52020300	FLTRVH05	FLTRV202	FLTRVP03	-	-
1654587C1	FLT52020100	FLTRVH05	FLTRV202	FLTRVP01	-	-
1654587C2	FLT52020100	FLTRVH05	FLTRV202	FLTRVP01	-	-
1654589C1	FLT42020100	FLTRVH04	FLTRV202	FLTRVP01	-	-
1656773C91	FLT72020100	FLTRVH07	FLTRV202	FLTRVP01	-	-
1657078C91	FLT72010101	FLTRVH07	FLTRV201	FLTRVP01	FLTRVS01	-
1657424C91	FLT62010100	FLTRVH06	FLTRV201	FLTRVP01	-	-
1657425C91	FLT62010101	FLTRVH06	FLTRV201	FLTRVP01	FLTRVS01	-
1659712C1	FLT22030100	FLTRVH02	FLTRV203	FLTRVP01	-	Yes
1659713C1	FLT22240203	FLTRVH02	FLTRV224	FLTRVP02	FLTRVS03	Yes
1659949C1	FLT42020100	FLTRVH04	FLTRV202	FLTRVP01	-	-
1660907C91	FLT42020100	FLTRVH04	FLTRV202	FLTRVP01	-	-
1665310C1	FLT22081303	FLTRVH02	FLTRV208	FLTRVP13	FLTRVS03	Yes
1666056C91	FLT62010101	FLTRVH06	FLTRV201	FLTRVP01	FLTRVS01	-
1666056C92	FLT62010101	FLTRVH06	FLTRV201	FLTRVP01	FLTRVS01	-
1666955C1	FLT12070200	FLTRVH01	FLTRV207	FLTRVP02	-	Yes
1668811C1	FLT22220000	FLTRVH02	FLTRV222	-	-	-
1672963C1	FLT12280002	FLTRVH01	FLTRV228	-	FLTRVS02	Yes
1673889C1	FLT72010101	FLTRVH07	FLTRV201	FLTRVP01	FLTRVS01	-
1673889C91	FLT72010101	FLTRVH07	FLTRV201	FLTRVP01	FLTRVS01	-
1689479C1	FLT41020000	FLTRVH04	FLTRV102	-	-	-
1689480C1	FLT21180000	FLTRVH02	FLTRV118	-	-	-
1689481C1	FLT41020000	FLTRVH04	FLTRV102	-	-	-
1689481C2	FLT41020000	FLTRVH04	FLTRV102	-	-	-
1689482C1	FLT41150000	FLTRVH04	FLTRV115	-	-	-
1689936C1	FLT21190000	FLTRVH02	FLTRV119	-	-	-
1690060C1	FLT21190000	FLTRVH02	FLTRV119	-	-	-
1696302C1	FLT22220000	FLTRVH02	FLTRV222	-	-	-
2001023C1	FLT41050000	FLTRVH04	FLTRV105	-	-	-
2004860C1	FLT41050000	FLTRVH04	FLTRV105	-	-	-
2005257C1	FLT061050000	FLTRVH06	FLTRV105	-	-	-
2009769C1	FLT61050001	FLTRVH06	FLTRV105	-	FLTRVS01	-
2014041C1	FLT12070200	FLTRVH01	FLTRV207	FLTRVP02	-	Yes
2014041C2	FLT12070200	FLTRVH01	FLTRV207	FLTRVP02	-	Yes
2014042C1	FLT12280002	FLTRVH01	FLTRV228	-	FLTRVS02	Yes
2021376C1	FLT41050000	FLTRVH04	FLTRV105	-	-	-
2021954C1	FLT41050000	FLTRVH04	FLTRV105	-	-	-
2022685C1	FLT031110000	FLTRVH03	FLTRV111	-	-	-
2022686C1	FLT031110000	FLTRVH03	FLTRV111	-	-	-
2027495C1	FLT41050000	FLTRVH04	FLTRV105	-	-	-
2033827C1	FLT031110000	FLTRVH03	FLTRV111	-	-	-
2036481C91	FLT31230000	FLTRVH03	FLTRV123	-	-	-

Mfr. Part #	Fleetrite Part #	Head	Bracket	Pilot Adapter	Special	New Fan Required
2038840C1	FLT031110000	FLTRVH03	FLTRV111	-	-	-
2587815C1	FLT031110000	FLTRVH03	FLTRV111	-	-	-
2591440C93	FLT041010000	FLTRVH04	FLTRV101	-	-	-
2599303C1	FLT031110000	FLTRVH03	FLTRV111	-	-	-
2599304C1	FLT12220000	FLTRVH01	FLTRV222	-	-	-
2599305C1	FLT12150000	FLTRVH01	FLTRV215	-	-	-
2599306C1	FLT12030103	FLTRVH01	FLTRV203	FLTRVP01	FLTRVS03	-
2599307C1	FLT42020100	FLTRVH04	FLTRV202	FLTRVP01	-	-
2599312C1	FLT22030103	FLTRVH02	FLTRV203	FLTRVP01	FLTRVS03	-
2599314C1	FLT52020100	FLTRVH05	FLTRV201	FLTRVP01	-	-
2600368C92	FLT62010100	FLTRVH06	FLTRV201	FLTRVP01	-	-
2601077C1	FLT52010100	FLTRVH05	FLTRV201	FLTRVP01	-	-
2601973C1	FLT031110000	FLTRVH03	FLTRV111	-	-	-
2601974C1	FLT021090000	FLTRVH02	FLTRV109	-	-	-
2601975C1	FLT021090000	FLTRVH02	FLTRV109	-	-	-
2602036C1	FLT21080003	FLTRVH02	FLTRV108	-	FLTRVS03	-
2602037C91	FLT41020000	FLTRVH04	FLTRV102	-	-	-
2602038C1	FLT021090000	FLTRVH02	FLTRV109	-	-	-
2602039C1	FLT21070000	FLTRVH02	FLTRV107	-	-	-
2602040C1	FLT21060000	FLTRVH02	FLTRV106	-	-	-
2602041C1	FLT031110000	FLTRVH03	FLTRV111	-	-	-
2602044C1	FLT031110000	FLTRVH03	FLTRV111	-	-	-
2602192C1	FLT21170000	FLTRVH02	FLTRV117	-	-	-
2602193C1	FLT021090000	FLTRVH02	FLTRV109	-	-	-
2997433C1	FLT72010100	FLTRVH07	FLTRV201	FLTRVP01	-	-
3514275C1	FLT31230000	FLTRVH03	FLTRV123	-	-	-
3516398C1	FLT51050000	FLTRVH05	FLTRV105	-	-	-
3522786C2	FLT021090000	FLTRVH02	FLTRV109	-	-	-
3522786C3	FLT021090000	FLTRVH02	FLTRV109	-	-	-
3522788C2	FLT41050000	FLTRVH04	FLTRV105	-	-	-
3522788C3	FLT41050000	FLTRVH04	FLTRV105	-	-	-
3522788C91	FLT41050000	FLTRVH04	FLTRV105	-	-	-
3533032C3	FLT021090000	FLTRVH02	FLTRV109	-	-	-
3540116C2	FLT061050000	FLTRVH06	FLTRV105	-	-	-
3540116C3	FLT061050000	FLTRVH06	FLTRV105	-	-	-
3540116C4	FLT061050000	FLTRVH06	FLTRV105	-	-	-
3540983C1	FLT031110000	FLTRVH03	FLTRV111	-	-	-
3540983C2	FLT031110000	FLTRVH03	FLTRV111	-	-	-
3540983C3	FLT031110000	FLTRVH03	FLTRV111	-	-	-
3540984C1	FLT031110000	FLTRVH03	FLTRV111	-	-	-
3540984C2	FLT031110000	FLTRVH03	FLTRV111	-	-	-
3540985C2	FLT021090000	FLTRVH02	FLTRV109	-	-	-
3540985C3	FLT021090000	FLTRVH02	FLTRV109	-	-	-
3546534C2	FLT21070000	FLTRVH02	FLTRV107	-	-	-
3547775C2	FLT031110000	FLTRVH03	FLTRV111	-	-	-
3547775C3	FLT031110000	FLTRVH03	FLTRV111	-	-	-
3552595C1	FLT41050000	FLTRVH04	FLTRV105	-	-	-
3552595C3	FLT41050000	FLTRVH04	FLTRV105	-	-	-
3552595C4	FLT51050000	FLTRVH05	FLTRV105	-	-	-
3584438C1	FLT061040003	FLTRVH06	FLTRV104	-	FLTRVS03	-
3584438C2	FLT061040003	FLTRVH06	FLTRV104	-	FLTRVS03	-
3584438C3	FLT061040003	FLTRVH06	FLTRV104	-	FLTRVS03	-
3584452C1	FLT21080003	FLTRVH02	FLTRV108	-	FLTRVS03	-
3585866C1	FLT21170000	FLTRVH02	FLTRV117	-	-	-
3586345C2	FLT21060000	FLTRVH02	FLTRV106	-	-	-
3588739C1	FLT041010000	FLTRVH04	FLTRV101	-	-	-
3588739C2	FLT041010000	FLTRVH04	FLTRV101	-	-	-
3588739C3	FLT041010000	FLTRVH04	FLTRV101	-	-	-
3609117C2	FLT071040003	FLTRVH07	FLTRV104	-	FLTRVS03	-
3611897C2	FLT71050000	FLTRVH07	FLTRV105	-	-	-
3615038C3	FLT41030000	FLTRVH04	FLTRV103	-	-	-
3615038C4	FLT41030000	FLTRVH04	FLTRV103	-	-	-
3812002C1	FLT041010000	FLTRVH04	FLTRV101	-	-	-
507271C2	FLT52010101	FLTRVH05	FLTRV201	FLTRVP01	FLTRVS01	-
537481C2	FLT22030100	FLTRVH02	FLTRV203	FLTRVP01	-	-
YB-3000	FLT21060000	FLTRVH02	FLTRV106	-	-	-
YB-3130	FLT21080003	FLTRVH02	FLTRV108	-	FLTRVS03	-
YB-625	FLT41050000	FLTRVH04	FLTRV105	-	-	-
YB-626	FLT21070000	FLTRVH02	FLTRV107	-	-	-
MAK						
1MH29305BP2	FLT72010101	FLTRVH07	FLTRV201	FLTRVP01	FLTRVS01	-
1MH29305BP3	FLT72010101	FLTRVH07	FLTRV201	FLTRVP01	FLTRVS01	-
1MH29305P2	FLT72010101	FLTRVH07	FLTRV201	FLTRVP01	FLTRVS01	-

Mfr. Part #	Fleetrite Part #	Head	Bracket	Pilot Adapter	Special	New Fan Required
1MH29305P2	FLT72010101	FLTRVH07	FLTRV201	FLTRVP01	FLTRVS01	-
2MH354AP2	FLT22030000	FLTRVH07	FLTRV203	-	-	-
38MH304	FLT72010100	FLTRVH07	FLTRV201	FLTRVP01	-	-
38MH31	FLT22030000	FLTRVH02	FLTRV203	-	-	-
38MH313	FLT72010100	FLTRVH07	FLTRV201	FLTRVP01	-	-
38MH317A	FLT72010101	FLTRVH07	FLTRV201	FLTRVP01	FLTRVS01	-
38MH318	FLT42010000	FLTRVH04	FLTRV201	-	-	-
38MH31AP1	FLT22030000	FLTRVH02	FLTRV203	-	-	-
38MH31AP2	FLT22030000	FLTRVH02	FLTRV203	-	-	-
38MH31P2	FLT22030000	FLTRVH02	FLTRV203	-	-	-
38MH37	FLT22030000	FLTRVH02	FLTRV203	-	-	-
38MH37A	FLT22030000	FLTRVH02	FLTRV203	-	-	-
38MH37AP2	FLT22030000	FLTRVH02	FLTRV203	-	-	-
38MH37AP2	FLT22030000	FLTRVH02	FLTRV203	-	-	-
38MH414M	FLT42010000	FLTRVH04	FLTRV201	-	-	-
38MH416	FLT12030000	FLTRVH01	FLTRV203	-	-	-
38MH416P1	FLT12030000	FLTRVH01	FLTRV203	-	-	-
38MH416P2	FLT22030000	FLTRVH02	FLTRV203	-	-	-
38MH420	FLT22230000	FLTRVH02	FLTRV223	-	-	-
38MH421M	FLT42020000	FLTRVH04	FLTRV202	-	-	-
38MH423M	FLT42020000	FLTRVH04	FLTRV202	-	-	-
38MH424M	FLT42010000	FLTRVH04	FLTRV201	-	-	-
PETERBILT						
05-18431-000	FLT42200500	FLTRVH04	FLTRV220	FLTRVP05	-	-
05-18815-000	FLT52100000	FLTRVH05	FLTRV210	-	-	-
05-18815-000	FLT52100000	FLTRVH05	FLTRV210	-	-	-
05-18953-000	FLT52200500	FLTRVH05	FLTRV220	FLTRVP05	-	-
05-19326-000	FLT72020100	FLTRVH07	FLTRV202	FLTRVP01	-	-
05-19373-000	FLT41120002	FLTRVH04	FLTRV112	-	FLTRVS02	-
05-19481-000	FLT42010100	FLTRVH04	FLTRV201	FLTRVP01	-	-
SCHWITZER						
156314	FLT52010101	FLTRVH05	FLTRV201	FLTRVP01	FLTRVS01	-
166054	FLT41050000	FLTRVH04	FLTRV105	-	-	-
166223	FLT061050000	FLTRVH06	FLTRV105	-	-	-
166283	FLT41050000	FLTRVH04	FLTRV105	-	-	-
166301	FLT12070200	FLTRVH01	FLTRV207	FLTRVP02	-	Yes
166302	FLT22240203	FLTRVH02	FLTRV224	FLTRVP02	FLTRVS03	Yes
166303	FLT22240203	FLTRVH02	FLTRV224	FLTRVP02	FLTRVS03	Yes
166305	FLT12280002	FLTRVH01	FLTRV228	-	FLTRVS02	Yes
166306	FLT12070200	FLTRVH01	FLTRV207	FLTRVP02	-	Yes
166400	FLT21060002	FLTRVH02	FLTRV106	-	FLTRVS02	Yes
166499	FLT61050001	FLTRVH06	FLTRV105	-	FLTRVS01	-
166881	FLT031110000	FLTRVH03	FLTRV111	-	-	-
166923	FLT72010101	FLTRVH07	FLTRV201	FLTRVP01	FLTRVS01	-
167046	FLT41050000	FLTRVH04	FLTRV105	-	-	-
167047	FLT41050000	FLTRVH04	FLTRV105	-	-	-
167071	FLT031110000	FLTRVH03	FLTRV111	-	-	-
167118	FLT41020000	FLTRVH04	FLTRV102	-	-	-
167119	FLT12070200	FLTRVH01	FLTRV207	FLTRVP02	-	Yes
167121	FLT22270000	FLTRVH02	FLTRV227	-	-	-
167222	FLT22220000	FLTRVH02	FLTRV222	-	-	-
167341	FLT41050000	FLTRVH04	FLTRV105	-	-	-
167421	FLT031110000	FLTRVH03	FLTRV111	-	-	-
167852	FLT31230000	FLTRVH03	FLTRV123	-	-	-
167981	FLT031110000	FLTRVH03	FLTRV111	-	-	-
168395	FLT31100002	FLTRVH03	FLTRV110	-	FLTRVS02	-
168607	FLT52010101	FLTRVH05	FLTRV201	FLTRVP01	FLTRVS01	-
168610	FLT52010101	FLTRVH05	FLTRV201	FLTRVP01	FLTRVS01	-
168815	FLT11060002	FLTRVH01	FLTRV106	-	FLTRVS02	Yes
168821	FLT42010000	FLTRVH04	FLTRV201	-	-	-
169238	FLT11200002	FLTRVH01	FLTRV120	-	FLTRVS02	-
169308	FLT12240003	FLTRVH01	FLTRV224	-	FLTRVS03	Yes
169366	FLT41020000	FLTRVH04	FLTRV102	-	-	-
169380	FLT31230000	FLTRVH03	FLTRV123	-	-	-
169422	FLT51050000	FLTRVH05	FLTRV105	-	-	-
169540	FLT52010100	FLTRVH05	FLTRV201	FLTRVP01	-	-
169541	FLT52010100	FLTRVH05	FLTRV201	FLTRVP01	-	-
169575	FLT41050000	FLTRVH04	FLTRV105	-	-	-
169683	FLT41050000	FLTRVH04	FLTRV105	-	-	-
169684	FLT41050000	FLTRVH04	FLTRV105	-	-	-
170337	FLT22070200	FLTRVH02	FLTRV207	FLTRVP02	-	Yes
182587	FLT12030000	FLTRVH01	FLTRV203	-	-	-
183125	FLT22030000	FLTRVH02	FLTRV203	-	-	-
183145	FLT72010101	FLTRVH07	FLTRV201	FLTRVP01	FLTRVS01	-
183831	FLT22160000	FLTRVH02	FLTRV216	-	-	-

Mfr. Part #	Fleetrite Part #	Head	Bracket	Pilot Adapter	Special	New Fan Required
184394	FLT22170000	FLTRVH02	FLTRV217	-	-	-
186116	FLT21120000	FLTRVH02	FLTRV112	-	-	-
186152	FLT72010101	FLTRVH07	FLTRV201	FLTRVP01	FLTRVS01	-
186302	FLT22030000	FLTRVH02	FLTRV203	-	-	-
186303	FLT42020000	FLTRVH04	FLTRV202	-	-	-
186315	FLT72010001	FLTRVH07	FLTRV201	-	FLTRVS01	-
186345	FLT22030100	FLTRVH02	FLTRV203	FLTRVP01	-	-
187170	FLT22171400	FLTRVH02	FLTRV217	FLTRVP14	-	-
187182	FLT52010101	FLTRVH05	FLTRV201	FLTRVP01	FLTRVS01	-
187199	FLT52010101	FLTRVH05	FLTRV201	FLTRVP01	FLTRVS01	-
187242	FLT22030100	FLTRVH02	FLTRV203	FLTRVP01	-	-
187243	FLT52010101	FLTRVH05	FLTRV201	FLTRVP01	FLTRVS01	-
187415	FLT72010101	FLTRVH07	FLTRV201	FLTRVP01	FLTRVS01	-
187509	FLT52020000	FLTRVH05	FLTRV202	-	-	-
187604	FLT72010101	FLTRVH07	FLTRV201	FLTRVP01	FLTRVS01	-
187605	FLT72011101	FLTRVH07	FLTRV201	FLTRVP11	FLTRVS01	-
187670	FLT72010100	FLTRVH07	FLTRV201	FLTRVP01	-	-
187671	FLT72010101	FLTRVH07	FLTRV201	FLTRVP01	FLTRVS01	-
187739	FLT72010101	FLTRVH07	FLTRV201	FLTRVP01	FLTRVS01	-
187745	FLT72011100	FLTRVH07	FLTRV201	FLTRVP11	-	-
187781	FLT22030000	FLTRVH02	FLTRV203	-	-	-
187806	FLT72010101	FLTRVH07	FLTRV201	FLTRVP01	FLTRVS01	-
188121	FLT52010101	FLTRVH05	FLTRV201	FLTRVP01	FLTRVS01	-
188126	FLT72010101	FLTRVH07	FLTRV201	FLTRVP01	FLTRVS01	-
188206	FLT72020100	FLTRVH07	FLTRV202	FLTRVP01	-	-
188209	FLT52010101	FLTRVH05	FLTRV201	FLTRVP01	FLTRVS01	-
188212	FLT72010101	FLTRVH07	FLTRV201	FLTRVP01	FLTRVS01	-
188245	FLT72010101	FLTRVH07	FLTRV201	FLTRVP01	FLTRVS01	-
188607	FLT52010100	FLTRVH05	FLTRV201	FLTRVP01	-	-
188640	FLT52010100	FLTRVH05	FLTRV201	FLTRVP01	-	-
188667	FLT72010100	FLTRVH07	FLTRV201	FLTRVP01	-	-
188680	FLT72010101	FLTRVH07	FLTRV201	FLTRVP01	FLTRVS01	-
188723	FLT42131501	FLTRVH04	FLTRV213	FLTRVP15	FLTRVS01	-
188958	FLT72010101	FLTRVH07	FLTRV201	FLTRVP01	FLTRVS01	-
189033	FLT52010101	FLTRVH05	FLTRV201	FLTRVP01	FLTRVS01	-
189035	FLT52010101	FLTRVH05	FLTRV201	FLTRVP01	FLTRVS01	-
189039	FLT52010101	FLTRVH05	FLTRV201	FLTRVP01	FLTRVS01	-
189040	FLT52010101	FLTRVH05	FLTRV201	FLTRVP01	FLTRVS01	-
189176	FLT72010100	FLTRVH07	FLTRV201	FLTRVP01	-	-
189194	FLT72010101	FLTRVH07	FLTRV201	FLTRVP01	FLTRVS01	-
189812	FLT22150000	FLTRVH02	FLTRV215	-	-	-
191401	FLT52010101	FLTRVH05	FLTRV201	FLTRVP01	FLTRVS01	-
191431	FLT22030000	FLTRVH02	FLTRV203	-	-	-
191529	FLT72010101	FLTRVH07	FLTRV201	FLTRVP01	FLTRVS01	-
192006	FLT21060002	FLTRVH02	FLTRV106	-	FLTRVS02	-
192034	FLT11060002	FLTRVH01	FLTRV106	-	FLTRVS02	-
192037	FLT11060002	FLTRVH01	FLTRV106	-	FLTRVS02	Yes
192051	FLT11060002	FLTRVH01	FLTRV106	-	FLTRVS02	Yes
192118	FLT72010100	FLTRVH07	FLTRV201	FLTRVP01	-	-
192119	FLT72010100	FLTRVH07	FLTRV201	FLTRVP01	-	-
192155	FLT21060002	FLTRVH02	FLTRV106	-	FLTRVS02	-
192312	FLT11060002	FLTRVH01	FLTRV106	-	FLTRVS02	Yes
192361	FLT11060002	FLTRVH01	FLTRV106	-	FLTRVS02	Yes
192372	FLT72010101	FLTRVH07	FLTRV201	FLTRVP01	FLTRVS01	-
192379	FLT11060002	FLTRVH01	FLTRV106	-	FLTRVS02	-
192497	FLT11060002	FLTRVH01	FLTRV106	-	FLTRVS02	-
193251	FLT12030000	FLTRVH01	FLTRV203	-	-	-
193707	FLT52020000	FLTRVH05	FLTRV202	-	-	-
193758	FLT72010101	FLTRVH07	FLTRV201	FLTRVP01	FLTRVS01	-
193958	FLT72010101	FLTRVH07	FLTRV201	FLTRVP01	FLTRVS01	-
194020	FLT72090001	FLTRVH07	FLTRV209	-	FLTRVS01	-
194021	FLT72100001	FLTRVH07	FLTRV210	-	FLTRVS01	-
194038	FLT22150000	FLTRVH02	FLTRV215	-	-	-
194169	FLT72010101	FLTRVH07	FLTRV201	FLTRVP01	FLTRVS01	-
194182	FLT52010001	FLTRVH05	FLTRV201	-	FLTRVS01	-
194189	FLT72011101	FLTRVH07	FLTRV201	FLTRVP11	FLTRVS01	-
194374	FLT72020100	FLTRVH07	FLTRV202	FLTRVP01	-	-
194421	FLT22030000	FLTRVH02	FLTRV203	-	-	-
194422	FLT42020000	FLTRVH04	FLTRV202	-	-	-
194767	FLT52010101	FLTRVH05	FLTRV201	FLTRVP01	FLTRVS01	-
194861	FLT12030000	FLTRVH01	FLTRV203	-	-	-
194862	FLT22030000	FLTRVH02	FLTRV203	-	-	-
194974	FLT52010100	FLTRVH05	FLTRV201	FLTRVP01	-	-
194986	FLT42020100	FLTRVH04	FLTRV202	FLTRVP01	-	-
196002	FLT72010101	FLTRVH07	FLTRV201	FLTRVP01	FLTRVS01	-

Cross Reference Viscous Fan Clutches

Mfr. Part #	Fleetrite Part #	Head	Bracket	Pilot Adapter	Special	New Fan Required
196054	FLT22230000	FLTRVH02	FLTRV223	-	-	-
196102	FLT52020300	FLTRVH05	FLTRV202	FLTRVP03	-	-
196103	FLT52020100	FLTRVH05	FLTRV202	FLTRVP01	-	-
196131	FLT12230000	FLTRVH01	FLTRV223	-	-	-
196133	FLT62010101	FLTRVH06	FLTRV201	FLTRVP01	FLTRVS01	-
196135	FLT62010100	FLTRVH06	FLTRV201	FLTRVP01	-	-
196181	FLT42020100	FLTRVH04	FLTRV202	FLTRVP01	-	-
196291	FLT42020100	FLTRVH04	FLTRV202	FLTRVP01	-	-
196350	FLT52010100	FLTRVH05	FLTRV201	FLTRVP01	-	-
196407	FLT52010101	FLTRVH05	FLTRV201	FLTRVP01	FLTRVS01	-
196408	FLT72090001	FLTRVH07	FLTRV209	-	FLTRVS01	-
196567	FLT22171400	FLTRVH02	FLTRV217	FLTRVP14	-	-
196568	FLT21220000	FLTRVH02	FLTRV122	-	-	-
196617	FLT72010101	FLTRVH07	FLTRV201	FLTRVP01	FLTRVS01	-
196704	FLT72010101	FLTRVH07	FLTRV201	FLTRVP01	FLTRVS01	-
196753	FLT42010000	FLTRVH04	FLTRV201	-	-	-
196792	FLT72010100	FLTRVH07	FLTRV201	FLTRVP01	-	-
196932	FLT72020101	FLTRVH07	FLTRV202	FLTRVP01	-	-
197050	FLT52010101	FLTRVH05	FLTRV201	FLTRVP01	FLTRVS01	-
197089	FLT42010100	FLTRVH04	FLTRV201	FLTRVP01	-	-
197189	FLT52120000	FLTRVH05	FLTRV212	-	-	-
197434	FLT52010100	FLTRVH07	FLTRV201	FLTRVP01	-	-
197704	FLT72010101	FLTRVH07	FLTRV201	FLTRVP01	FLTRVS01	-
197705	FLT72010101	FLTRVH07	FLTRV201	FLTRVP01	FLTRVS01	-
197778	FLT62010101	FLTRVH06	FLTRV201	FLTRVP01	FLTRVS01	-
197780	FLT41120000	FLTRVH04	FLTRV112	-	-	-
197805	FLT62010101	FLTRVH06	FLTRV201	FLTRVP01	FLTRVS01	-
197853	FLT42010100	FLTRVH04	FLTRV201	FLTRVP01	-	-
197869	FLT52010101	FLTRVH05	FLTRV201	FLTRVP01	FLTRVS01	-
197871	FLT72010101	FLTRVH07	FLTRV201	FLTRVP01	FLTRVS01	-
197874	FLT72010101	FLTRVH07	FLTRV201	FLTRVP01	FLTRVS01	-
197879	FLT42020100	FLTRVH04	FLTRV202	FLTRVP01	-	-
197880	FLT72010101	FLTRVH07	FLTRV201	FLTRVP01	FLTRVS01	-
197884	FLT62010101	FLTRVH06	FLTRV201	FLTRVP01	FLTRVS01	-
197885	FLT62010100	FLTRVH06	FLTRV201	FLTRVP01	-	-
197893	FLT72010101	FLTRVH07	FLTRV201	FLTRVP01	FLTRVS01	-
197894	FLT72010101	FLTRVH07	FLTRV201	FLTRVP01	FLTRVS01	-
198038	FLT52120000	FLTRVH05	FLTRV212	-	-	-
198039	FLT41210000	FLTRVH04	FLTRV121	-	-	-
198048	FLT42010000	FLTRVH04	FLTRV201	-	-	-
198057	FLT22030000	FLTRVH02	FLTRV203	-	-	-
198195	FLT72010101	FLTRVH07	FLTRV201	FLTRVP01	FLTRVS01	-
198197	FLT72010101	FLTRVH07	FLTRV201	FLTRVP01	FLTRVS01	-
198212	FLT72010101	FLTRVH07	FLTRV201	FLTRVP01	FLTRVS01	-
198241	FLT72010100	FLTRVH07	FLTRV201	FLTRVP01	-	-
198242	FLT72010100	FLTRVH07	FLTRV201	FLTRVP01	-	-
198249	FLT52010101	FLTRVH05	FLTRV201	FLTRVP01	FLTRVS01	-
198380	FLT62010100	FLTRVH06	FLTRV201	FLTRVP01	-	-
198381	FLT62010101	FLTRVH06	FLTRV201	FLTRVP01	FLTRVS01	-
198387	FLT52011601	FLTRVH05	FLTRV201	FLTRVP16	FLTRVS01	-
198859	FLT72010101	FLTRVH07	FLTRV201	FLTRVP01	FLTRVS01	-
198946	FLT12030000	FLTRVH01	FLTRV203	-	-	-
199076	FLT52090001	FLTRVH05	FLTRV209	-	FLTRVS01	-
199159	FLT22171400	FLTRVH02	FLTRV217	FLTRVP14	-	-
199412	FLT52010101	FLTRVH05	FLTRV201	FLTRVP01	FLTRVS01	-
199463	FLT22270000	FLTRVH02	FLTRV227	-	-	-
199511	FLT72010101	FLTRVH07	FLTRV201	FLTRVP01	FLTRVS01	-
199628	FLT72010100	FLTRVH07	FLTRV201	FLTRVP01	-	-
199807	FLT41020000	FLTRVH04	FLTRV102	-	-	-
199809	FLT21190000	FLTRVH02	FLTRV119	-	-	-
199810	FLT41020000	FLTRVH04	FLTRV102	-	-	-
199811	FLT21180000	FLTRVH02	FLTRV118	-	-	-
199812	FLT41150000	FLTRVH04	FLTRV115	-	-	-
199840	FLT72140000	FLTRVH07	FLTRV214	-	-	-
VOLVO						
1118850	FLT72010100	FLTRVH07	FLTRV201	FLTRVP01	-	-
1119912	FLT22030000	FLTRVH02	FLTRV203	-	-	-
1119915	FLT52010101	FLTRVH05	FLTRV201	FLTRVP01	FLTRVS01	-
1119916	FLT22030000	FLTRVH02	FLTRV203	-	-	-
15044771	FLT41140000	FLTRVH04	FLTRV114	-	-	-
15504174	FLT22030300	FLTRVH02	FLTRV203	FLTRVP03	-	-
15684550	FLT11060002	FLTRVH01	FLTRV106	-	FLTRVS02	-
15716073	FLT41120002	FLTRVH04	FLTRV112	-	FLTRVS02	-
15718025	FLT41120002	FLTRVH04	FLTRV112	-	FLTRVS02	-
15767378	FLT11060000	FLTRVH01	FLTRV106	-	-	-

Mfr. Part #	Fleetrite Part #	Head	Bracket	Pilot Adapter	Special	New Fan Required
15990495	FLT11060002	FLTRVH01	FLTRV106	-	FLTRVS02	-
15990496	FLT41120002	FLTRVH04	FLTRV112	-	FLTRVS02	-
15995659	FLT41120002	FLTRVH04	FLTRV112	-	FLTRVS02	-
1675036	FLT72210000	FLTRVH07	FLTRV221	-	-	-
2045349	FLT72010101	FLTRVH07	FLTRV201	FLTRVP01	FLTRVS01	-
20811-3207	FLT72010101	FLTRVH07	FLTRV201	FLTRVP01	FLTRVS01	-
20822-0019	FLT72010101	FLTRVH07	FLTRV201	FLTRVP01	FLTRVS01	-
20822-0022	FLT72010101	FLTRVH07	FLTRV201	FLTRVP01	FLTRVS01	-
20822-0035	FLT72010101	FLTRVH07	FLTRV201	FLTRVP01	FLTRVS01	-
20822-0126	FLT72010101	FLTRVH07	FLTRV201	FLTRVP01	FLTRVS01	-
20822-0130	FLT72020100	FLTRVH07	FLTRV202	FLTRVP01	-	-
20822-0170	FLT72010101	FLTRVH07	FLTRV201	FLTRVP01	FLTRVS01	-
20822-0188	FLT72010101	FLTRVH07	FLTRV201	FLTRVP01	FLTRVS01	-
20822-3206	FLT72010101	FLTRVH07	FLTRV201	FLTRVP01	FLTRVS01	-
20822-3207	FLT72010101	FLTRVH07	FLTRV201	FLTRVP01	FLTRVS01	-
20822-3208	FLT72010100	FLTRVH07	FLTRV201	FLTRVP01	-	-
20822-3209	FLT72010100	FLTRVH07	FLTRV201	FLTRVP01	-	-
20822-3459	FLT72010100	FLTRVH07	FLTRV201	FLTRVP01	-	-
20822-3463	FLT72010100	FLTRVH07	FLTRV201	FLTRVP01	-	-
20822-3617	FLT72010101	FLTRVH07	FLTRV201	FLTRVP01	FLTRVS01	-
2092619	FLT72010101	FLTRVH07	FLTRV201	FLTRVP01	FLTRVS01	-
22578203	FLT12230000	FLTRVH01	FLTRV223	-	-	-
3918904	FLT22150000	FLTRVH02	FLTRV215	-	-	-
3945142	FLT52010100	FLTRVH05	FLTRV201	FLTRVP01	-	-
3945142	FLT52010100	FLTRVH05	FLTRV201	FLTRVP01	-	-
WESTERN STAR						
20822-0126	FLT72010101	FLTRVH07	FLTRV201	FLTRVP01	FLTRVS01	-
20822-0130	FLT72020100	FLTRVH07	FLTRV202	FLTRVP01	-	-
20822-0170	FLT72010101	FLTRVH07	FLTRV201	FLTRVP01	FLTRVS01	-
20822-0188	FLT72010101	FLTRVH07	FLTRV201	FLTRVP01	FLTRVS01	-
20822-3206	FLT72010101	FLTRVH07	FLTRV201	FLTRVP01	FLTRVS01	-
20822-3207	FLT72010101	FLTRVH07	FLTRV201	FLTRVP01	FLTRVS01	-
20822-3208	FLT72010100	FLTRVH07	FLTRV201	FLTRVP01	-	-
20822-3209	FLT72010100	FLTRVH07	FLTRV201	FLTRVP01	-	-

OEM Part #	Fleetrite Part #	Use Kit #	Pg. #	OEM Part #	Fleetrite Part #	Use Kit #	Pg. #	OEM Part #	Fleetrite Part #	Use Kit #	Pg. #
65480	FLT108621X	FLT106731		104904	FLT104904X	FLT104939		107970	FLT107970X	FLT104939	
65505	FLT109355X	FLT106731		104905	FLT104905X	FLT104939		108006	FLT108006X	FLT104941	
65520	FLT109376X	FLT106731		104906	FLT104906X	FLT104939		108057	FLT108122X	FLT106731	
65525	FLT109400X	FLT106731		104907	FLT104907X	FLT104937*		108122	FLT108122X	FLT106731	
104725	FLT104725X	FLT104939		104915	FLT104750X	FLT104939		108323	FLT108323X	FLT104939	
104735	FLT104735X	FLT104939		104916	FLT104751X	FLT104939		108378	FLT108380X	FLT106731	
104750	FLT104750X	FLT104939		104917	FLT104758X	FLT104939		108432	FLT108464X	FLT106731	
104751	FLT104751X	FLT104939		104918	FLT104761X	FLT104939		108445	FLT108450X	FLT106731	
104752	FLT104756X	FLT104941		104919	FLT104764X	FLT104939		108450	FLT108450X	FLT106731	
104753	FLT104757X	FLT104941		104920	FLT104767X	FLT104939		108460	FLT108460X	FLT106731	
104756	FLT104756X	FLT104941		104921	FLT104770X	FLT104939		108458	FLT108461GTN	-	
104757	FLT104757X	FLT104941		104922	FLT104773X	FLT104939		108459	FLT108460X	FLT106731	
104758	FLT104758X	FLT104939		104923	FLT104776X	FLT104939		108460	FLT108460X	FLT106731	
104759	FLT104760X	FLT104941		104924	FLT104779X	FLT104939		108461	FLT108461GTN	-	
104760	FLT104760X	FLT104941		104925	FLT104782X	FLT104939		108462	FLT108463X	FLT106731	
104761	FLT104761X	FLT104939		104926	FLT104785X	FLT104939		108463	FLT108463X	FLT106731	
104762	FLT104763X	FLT104941		104965	FLT104965X	FLT104939		108464	FLT108464X	FLT106731	
104763	FLT104763X	FLT104941		104981	FLT104981X	FLT104941		108483	FLT108483X	FLT106731	
104764	FLT104764X	FLT104939		104987	FLT104989X	FLT104941		108497	FLT108497X	FLT106731	
104765	FLT104765X	FLT104941		104988	FLT104990X	FLT104941		108530	FLT108530X	FLT106731	
104766	FLT104765X	FLT104941		104989	FLT104989X	FLT104941		108531	FLT108531X	FLT106731	
104767	FLT104767X	FLT104939		104990	FLT104990X	FLT104941		108532	FLT108532X	FLT106731	
104768	FLT104769X	FLT104941		106091	FLT106091X	FLT104941		108533	FLT108533X	FLT106731	
104769	FLT104769X	FLT104941		106092	FLT106092X	FLT104941		108534	FLT108534X	FLT106731	
104770	FLT104770X	FLT104939		106093	FLT106093X	FLT104941		108552	FLT108552X	FLT106731	
104771	FLT104772X	FLT104941		106095	FLT106095X	FLT104941		108553	FLT108553X	FLT106731	
104772	FLT104772X	FLT104941		106096	FLT106096X	FLT104941		108621	FLT108621X	FLT106731	
104773	FLT104773X	FLT104939		106097	FLT106097X	FLT104941		108629	FLT108633X	FLT106731	
104774	FLT104775X	FLT104941		106098	FLT106098X	FLT104941		108696	FLT108696X	FLT106731	
104775	FLT104775X	FLT104941		106099	FLT106099X	FLT104941		108697	FLT108697X	FLT106731	
104776	FLT104776X	FLT104939		106120	FLT106120X	FLT104941		108817	FLT108817X	FLT104939	
104777	FLT104778X	FLT104941		106235	FLT106235X	FLT104941		108893	FLT108893X	FLT106731	
104778	FLT104778X	FLT104941		106236	FLT106236X	FLT104941		109032	FLT109032X	FLT104939	
104779	FLT104779X	FLT104939		106237	FLT106876X	FLT104941		109171	FLT108621X	FLT106731	
104780	FLT104781X	FLT104941		106238	FLT106238X	FLT104941		109353	FLT109355X	FLT106731	
104781	FLT104781X	FLT104941		106270	FLT106270X	FLT104941		109354	FLT109355X	FLT106735	
104782	FLT104782X	FLT104939		106271	FLT106271X	FLT104941		109355	FLT109355X	FLT106735	
104783	FLT104784X	FLT104941		106272	FLT106272X	FLT104941		109372	FLT109376X	FLT106731	
104784	FLT104784X	FLT104941		106291	FLT106291X	FLT104941		109374	FLT109376X	FLT106731	
104785	FLT104785X	FLT104939		106350	FLT106350X	FLT104941		109375	FLT109375X	FLT106731	
104786	FLT104787X	FLT104941		106450	FLT106450X	FLT104941		109376	FLT109376X	FLT106731	
104787	FLT104787X	FLT104941		106723	FLT106724X	FLT106731		109386	FLT109386X	FLT104941	
104870	FLT104870X	FLT104939		106724	FLT106724X	FLT106731		109398	FLT109400X	FLT106735	
104871	FLT104871X	FLT104939		106734	FLT106970X	FLT106731		109399	FLT109400X	FLT106735	
104872	FLT104872X	FLT104939		106772	FLT106970X	FLT106731		109400	FLT109400X	FLT106735	
104873	FLT104873X	FLT104937*		106841	FLT106842X	FLT104941		287847	FLT104894X	FLT104939	
104874	FLT104874X	FLT104939		106842	FLT106842X	FLT104941		288028	FLT104870X	FLT104939	
104875	FLT104875X	FLT104939		106844	FLT106844X	FLT104939		288606	FLT104878X	FLT104939	
104876	FLT104876X	FLT104939		106866	FLT106866X	FLT104939		288610	FLT104873X	FLT104937*	
104877	FLT104877X	FLT104939		106876	FLT106876X	FLT104941		288614	FLT104874X	FLT104939	
104878	FLT104878X	FLT104939		106969	FLT106970X	FLT106731		288615	FLT104874X	FLT104939	
104879	FLT104879X	FLT104939		106970	FLT106970X	FLT106731		288626	FLT104782X	FLT104939	
104880	FLT104880X	FLT104939		106973	FLT106974X	FLT106731		288636	FLT104870X	FLT104939	
104881	FLT104881X	FLT104939		106974	FLT106974X	FLT106731		288670	FLT104873X	FLT104937*	
104882	FLT104882X	FLT104939		107147	FLT107147X	FLT104941		288689	FLT104782X	FLT104939	
104883	FLT104883X	FLT104939		107172	FLT107473X	FLT106731		288880	FLT104770X	FLT104939	
104884	FLT104884X	FLT104937*		107173	FLT107473X	FLT106731		288901	FLT104877X	FLT104939	
104885	FLT104885X	FLT104937*		107472	FLT107473X	FLT106731		288945	FLT104880X	FLT104939	
104886	FLT104886X	FLT104937*		107473	FLT107473X	FLT106731		288619	FLT104885X	FLT104937*	
104887	FLT104887X	FLT104939		107480	FLT107480X	FLT104939		288623	FLT104885X	FLT104937*	
104889	FLT104889X	FLT104939		107542	FLT107542X	FLT106731		288633	FLT104885X	FLT104937*	
104890	FLT104890X	FLT104939		107543	FLT107543X	FLT106731		288915	FLT104904X	FLT104939	
104891	FLT104891X	FLT104939		107544	FLT107544X	FLT106731		288916	FLT104904X	FLT104939	
104892	FLT104892X	FLT104937*		107580	FLT107580X	FLT104939		288931	FLT104897X	FLT104937*	
104893	FLT104893X	FLT104939		107626	FLT107627GTN	-		288938	FLT104892X	FLT104937*	
104894	FLT104894X	FLT104939		107627	FLT107627GTN	-		288997	FLT104883X	FLT104939	
104895	FLT104894X	FLT104939		107638	FLT107638X	FLT104939		289000	FLT104896X	FLT104937*	
104896	FLT104896X	FLT104937*		107815	FLT104981X	FLT104941		289064	FLT104899X	FLT104937*	
104897	FLT104897X	FLT104937*		107878	FLT107941X	FLT106731		289386	FLT104889X	FLT104939	
104898	FLT104898X	FLT104937*		107889	FLT107942X	FLT106731		289526	FLT104890X	FLT104939	
104899	FLT104899X	FLT104937*		107900	FLT107901GTN	-		289552	FLT104897X	FLT104937*	
104900	FLT104900X	FLT104937*		107901	FLT107901GTN	-		289565	FLT104901X	FLT104939	
104901	FLT104901X	FLT104939		107940	FLT107940X	-		289673	FLT104884X	FLT104937*	
104902	FLT104902X	FLT104939		107941	FLT107941X	FLT106731		289695	FLT104900X	FLT104937*	
104903	FLT104903X	FLT104939		107942	FLT107942X	FLT106731		289841	FLT104782X	FLT104939	

* Seal Kit Only

OEM #	Description	Fleetrite #	Use Kit #
1033-05435-02	K22 Front Air Seal Kit with Lining	-	FLT8000SKL
1033-05435-03	K22 Rear Air Seal Kit with Lining	-	FLT8500SKL
1033-07781-01	Bearing Kit for Pulley	-	FLTFLT858101
1033-07782-01	Bearing Kit for Pulley	-	FLTFLT858201
1033-07782-02	Bearing Kit for Pulley	-	FLTFLT858202
1033-07782-03	Bearing Kit for Pulley	-	FLTFLT858203
1033-07782-04	Bearing Kit for Pulley	-	FLTFLT858204
1033-08233-01	K22/K26 Rear Air Seal Kit	-	FLT8500SK
1033-08233-01	K22 Front Air Seal Kit	-	FLT8000SK
1033-08250-01	K22 Lining Kit	-	FLT8500L
1033-09339-01	K26 Rear Air Seal Kit with Lining	-	FLT8800SKL
1033-09340-01	K26 Lining Kit	-	FLT8800L
1033-40595-01	K30 Rear Air Aluminum Lining Kit	-	FLT8800L
1033-40595-02	K30 Rear Air Aluminum Seal Kit with Lining	-	FLT8800SKL
1033-40595-03	K30 Rear Air Aluminum Seal Kit	-	FLT8500SK
1033-40600-01	K32 Rear Air Lining Kit	-	FLT8800L
1033-40600-02	K32 Rear Air Seal Kit with Lining	-	FLT8800SKL
1033-40650-01	K32 Rear Air Aluminum Lining Kit	-	FLT8800L
1033-40650-02	K32 Rear Air Aluminum Seal Kit with Lining	-	FLT8800SKL
1090-07050-01	K22 Front Air Remanufactured Fan Clutch	FLT8001X	N/A
1090-08000-01	K22 Front Air Remanufactured Fan Clutch	FLT8001X	FLT8000SKL
1090-08000-05	K22 Front Air Remanufactured Fan Clutch	FLT8005X	FLT8000SKL
1090-08500-01	K22 Rear Air Remanufactured Fan Clutch	FLT8801N	FLT8500SKL
1090-08500-02	K22 Rear Air Remanufactured Fan Clutch	FLT8502X	FLT8500SKL
1090-08500-03	K22 Rear Air Remanufactured Fan Clutch	FLT8503X	FLT8500SKL
1090-09000-01	K26 Front Air Remanufactured Fan Clutch	FLT8001X	FLT8026SKL
1090-09000-05	K26 Front Air Remanufactured Fan Clutch	FLT8005X	N/A
1090-09500-01	K26 Rear Air Remanufactured Fan Clutch	FLT8801N	FLT8800SKL
1090-09500-03	K26 Rear Air Remanufactured Fan Clutch	FLT8803X	FLT8800SKL
1090-09600-01	K30 Rear Air Remanufactured Fan Clutch	FLT8801N	FLT8800SKL
1090-09650-01	K32 Rear Air Remanufactured Fan Clutch	FLT8801N	FLT8800SKL
1090-09800-01	K30 Rear Air Aluminum Remanufactured Fan Clutch	FLT8801N	FLT8800SKL
1090-09850-01	K32 Rear Air Aluminum Remanufactured Fan Clutch	FLT8801N	FLT8800SKL
1090-09900-01	K30 Rear Air Remanufactured Fan Clutch	FLT8801N	FLT8800SKBL
1090-09950-01	K32 Rear Air Remanufactured Fan Clutch	FLT8801N	FLT8800SKBL
9908500	K22 Rear Air Remanufactured Fan Clutch	FLT8801N	FLT8500SKL
9908501	K26 Rear Air Remanufactured Fan Clutch	FLT8801N	FLT8800SKL

How to order BorgWarner-Style rear air fan clutch assemblies.

BorgWarner on/off rear air fan clutch assemblies are two-piece systems. The first piece is the Fan Hub, which consists of an assembled pulley and mounting bracket. The second piece is the Fan Clutch, which turns on and off to engage the fan when cooling is required.

(Most part numbers start with 1077, 1093, or 1090, but some newer hubs and assemblies start with 0100.)

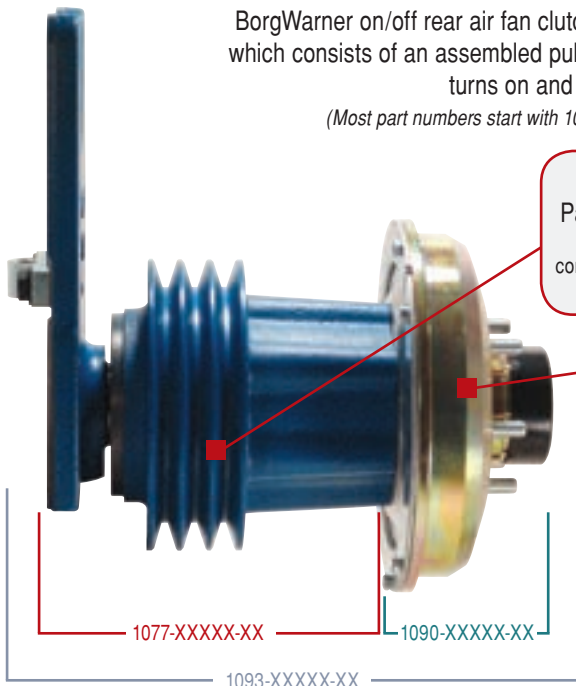

FAN HUB
Part Number 1077-XXXX-XX
Identified by tag on bracket or by contacting us with the casting number on bracket

FAN CLUTCH
Identified by tag on clutch or by using cross-reference based on Fan Hub part number.

Part number 1093-XXXX-XX refers to an entire BorgWarner-Style fan clutch assembly. It is for reference purposes only and not available for ordering.

The cross-reference guide that begins on the following page will break the assembly down into two part numbers for you to order (the Fan Hub number and Fan Clutch number).

If you are only replacing the Fan Clutch portion, you should also consider replacing the pulley bearings

OEM Part #		Fleetrite Part #	
Hub & Clutch Assy. Part #	Hub Only Part #	Hub Bearing Kit	Reman Fan Clutch #
010018934	FLT010019026	FLT858101	FLT8801X
010019007	FLT010019666	FLT858101	FLT8801X
010019573	FLT010019574	FLT858101	FLT8801X
010019587	FLT010019588	FLT858101	FLT8801X
010019599	FLT010019600	FLT858101	FLT8801X
010019630	FLT010019631	FLT858101	FLT8801X
010019857	FLT010020079	FLT858101	FLT8801X
010020034	FLT010020074	FLT858101	FLT8801X
010020084	FLT010020085	FLT858101	FLT8801X
010020090	FLT010020091	FLT858101	FLT8801X
010020173	FLT010020174	FLT858101	FLT8801X
010020177	FLT010020230	FLT858101	FLT8801X
010020199	FLT010020266	FLT858101	FLT8801X
010020204	FLT010020227	FLT858202	FLT8801X
010020205	FLT010020237	FLT858101	FLT8801X
010020225	FLT010020251	FLT858101	FLT8801X
010020226	FLT010020282	FLT858101	FLT8801X
010020247	FLT010020255	FLT858202	FLT8801X
010020248	FLT010020257	FLT858101	FLT8801X
010020262	FLT010020263	FLT858101	FLT8801X
010020314	FLT010020336	FLT858101	FLT8801X
010020315	FLT010020343	FLT858101	FLT8801X
010020354	FLT0100230367	FLT858101	FLT8801X
010020399	FLT010020400	FLT858101	FLT8801X
010020407	FLT010020408	FLT858101	FLT8801X
010020410	FLT010020411	FLT858101	FLT8801X
010020412	FLT010020429	FLT858101	FLT8801X
010020414	FLT010020476	FLT858101	FLT8801X
010020416	FLT010020417	FLT858101	FLT8801X
010020601	FLT010020602	FLT858101	FLT8801X
010020725	FLT010020625	FLT858101	FLT8801X
010020978	FLT010020392	FLT858101	FLT8801X
010021056	FLT010021057	FLT858101	FLT8801X
010021380	FLT010021557	FLT858202	FLT8801X
010021620	FLT010021694	FLT858101	FLT8801X
010021631	FLT010021781	FLT858101	FLT8801X
010021722	FLT010021720	FLT858101	FLT8801X
010021877	FLT010021905	FLT858101	FLT8801X
010021878	FLT010021930	FLT858101	FLT8801X
010021880	FLT010021931	FLT858101	FLT8801X
010021884	FLT010021933	FLT858101	FLT8801X
010021886	FLT010021934	FLT858101	FLT8801X
010021957	FLT010021984	FLT858101	FLT8801X
010022039	FLT010022071	FLT858101	FLT8801X
010022040	FLT010022386	FLT858101	FLT8801X
010022044	FLT010023057	FLT858101	FLT8801X
010022046	FLT010022119	FLT858101	FLT8801X
010022062	FLT010022209	FLT858101	FLT8801X
010022083	FLT010022084	FLT858101	FLT8801X
010022113	FLT010022246	FLT858101	FLT8801X
010022291	FLT010022319	FLT858101	FLT8801X
010022384	FLT010022404	FLT858101	FLT8801X
010022523	FLT010022588	FLT858101	FLT8801X
010022691	FLT010022690	FLT858101	FLT8801X
010022712	FLT010023067	FLT858101	FLT8801X
010022723	FLT010022721	FLT858101	FLT8801X
010022968	FLT010022967	FLT858101	FLT8801X
010022977	FLT010022976	FLT858101	FLT8801X
010022998	FLT010022997	FLT858101	FLT8801X
010023228	FLT010023533	FLT858101	FLT8805X
010023229	FLT010023627	FLT858101	FLT8805X
010023238	FLT010023307	FLT858101	FLT8805X
010023239	FLT010023292	FLT858101	FLT8805X
010023242	FLT010023308	FLT858101	FLT8805X
010023246	FLT010023421	FLT858101	FLT8805X
010023247	FLT010023382	FLT858101	FLT8805X
010023248	FLT010023512	FLT858101	FLT8805X
010023251	FLT010023400	FLT858101	FLT8805X
010023252	FLT010023478	FLT858101	FLT8805X
010023253	FLT010023549	FLT858101	FLT8805X
010023438	FLT010023436	FLT858101	FLT8805X
010023440	FLT010023441	FLT858101	FLT8805X
010023463	FLT010023462	FLT858101	FLT8805X

OEM Part #		Fleetrite Part #	
Hub & Clutch Assy. Part #	Hub Only Part #	Hub Bearing Kit	Reman Fan Clutch #
010023469	FLT010023468	FLT858101	FLT8805X
010023496	FLT010023497	FLT858101	FLT8801X
010023621	FLT010023849	FLT858101	FLT8801X
010023622	FLT010023803	FLT858101	FLT8801X
010023622	FLT010023803	FLT858101	FLT8801X
010023624	FLT010023786	FLT858101	FLT8801X
010023653	FLT010023652	FLT858101	FLT8805X
010023689	FLT010021905	FLT858101	FLT8801X
010023690	FLT010021931	FLT858101	FLT8801X
010023795	FLT010023436	FLT858101	FLT8801X
010023796	FLT010023533	FLT858101	FLT8801X
010023797	FLT010023652	FLT858101	FLT8801X
010023798	FLT010023441	FLT858101	FLT8801X
010023806	FLT010023421	FLT858101	FLT8801X
010023807	FLT010023512	FLT858101	FLT8801X
010023808	FLT010023627	FLT858101	FLT8801X
010023814	FLT010023478	FLT858101	FLT8801X
010023815	FLT010023549	FLT858101	FLT8801X
010023816	FLT010023462	FLT858101	FLT8801X
010023817	FLT010023307	FLT858101	FLT8801X
010023818	FLT010023292	FLT858101	FLT8801X
010023819	FLT010023436	FLT858101	FLT8801X
010023820	FLT010023308	FLT858101	FLT8801X
010023821	FLT010023382	FLT858101	FLT8801X
010023822	FLT010023400	FLT858101	FLT8801X
010023896	FLT010021694	FLT858101	FLT8801X
010023898	FLT010022386	FLT858101	FLT8801X
010023899	FLT010023057	FLT858101	FLT8801X
010023900	FLT010023786	FLT858101	FLT8801X
010023902	FLT010022209	FLT858101	FLT8801X
010023905	FLT010023497	FLT858101	FLT8801X
010023906	FLT010023849	FLT858101	FLT8801X
010023907	FLT010023803	FLT858101	FLT8801X
010023939	FLT010023938	FLT858101	FLT8801X
010023947	FLT010020625	FLT858101	FLT8801X
010023972	FLT010019574	FLT858101	FLT8801X
010023973	FLT010020174	FLT858101	FLT8801X
010023974	FLT010020625	FLT858101	FLT8801X
010023975	FLT010021057	FLT858101	FLT8801X
010023976	FLT010021557	FLT858202	FLT8801X
010023977	FLT010022246	FLT858101	FLT8801X
010023978	FLT010022319	FLT858101	FLT8801X
010023979	FLT010022404	FLT858101	FLT8801X
010023980	FLT010022588	FLT858101	FLT8801X
010023981	FLT010023067	FLT858101	FLT8801X
010023982	FLT010023402	FLT858101	FLT8801X
010023983	FLT010019445	FLT858101	FLT8801X
010024143	FLT010024141	FLT858101	FLT8801X
010024144	FLT010024141	FLT858101	FLT8805X
010024223	FLT010024224	FLT858101	FLT8805X
010024549	FLT010024552	FLT858101	FLT8801X
010026415	FLT010026419	FLT858101	FLT8801X
010026452	FLT010026419	FLT858101	FLT8801X
1093-07736-01	FLT10770773501	FLT858101	FLT8801X
1093-07736-02	FLT10770773502	FLT858101	FLT8801X
1093-07736-03	FLT10770773503	FLT858101	FLT8801X
1093-07736-04	FLT10770773504	FLT858101	FLT8801X
1093-07736-05	FLT10770773505	FLT858101	FLT8801X
1093-07736-06	FLT10770773506	FLT858101	FLT8801X
1093-07736-07	FLT10770773507	FLT858101	FLT8801X
1093-07736-08	FLT10770773508	FLT858101	FLT8801X
1093-07736-09	FLT10770773509	FLT858101	FLT8801X
1093-07736-10	FLT10770773510	FLT858101	FLT8801X
1093-07736-11	FLT10770773511	FLT858101	FLT8801X
1093-07736-12	FLT10770773512	FLT858101	FLT8801X
1093-07736-13	FLT10770773513	FLT858101	FLT8801X
1093-07736-14	FLT10770773514	FLT858101	FLT8801X
1093-07736-15	FLT10770773515	FLT858101	FLT8801X
1093-07740-01	FLT10770773801	FLT858201	FLT8801X
1093-07740-02	FLT10770773802	FLT858201	FLT8801X
1093-07740-03	FLT10770773803	FLT858201	FLT8801X
1093-07740-04	FLT10770773804	FLT858201	FLT8801X
1093-07740-05	FLT10770773805	FLT858201	FLT8801X
1093-07740-06	FLT10770773806	FLT858201	FLT8801X
1093-07740-07	FLT10770773807	FLT858201	FLT8801X

OEM Part #		Fleetrite Part #	
Hub & Clutch Assy. Part #	Hub Only Part #	Hub Bearing Kit	Reman Fan Clutch #
1093-07758-01	FLT10770775701	FLT858201	FLT8801X
1093-07758-02	FLT10770775702	FLT858201	FLT8801X
1093-07768-01	FLT10770776701	FLT858101	FLT8801X
1093-07768-02	FLT10770776702	FLT858101	FLT8801X
1093-07768-03	FLT10770776703	FLT858101	FLT8801X
1093-07768-04	FLT10770776704	FLT858101	FLT8801X
1093-07768-05	FLT10770776705	FLT858101	FLT8801X
1093-07768-06	FLT10770776706	FLT858101	FLT8801X
1093-07768-07	FLT10770776707	FLT858101	FLT8801X
1093-07768-08	FLT10770776708	FLT858101	FLT8801X
1093-07768-09	FLT10770776709	FLT858101	FLT8801X
1093-07771-01	FLT10770777001	FLT858101	FLT8801X
1093-07771-02	FLT10770777002	FLT858101	FLT8801X
1093-07771-03	FLT10770777003	FLT858101	FLT8801X
1093-07771-04	FLT10770777004	FLT858101	FLT8801X
1093-07771-05	FLT10770777005	FLT858101	FLT8801X
1093-07771-06	FLT10770777006	FLT858101	FLT8801X
1093-07771-07	FLT10770777007	FLT858101	FLT8801X
1093-07771-08	FLT10770777008	FLT858101	FLT8801X
1093-07771-09	FLT10770777009	FLT858101	FLT8801X
1093-07771-10	FLT10770777010	FLT858101	FLT8801X
1093-07771-11	FLT10770777011	FLT858101	FLT8801X
1093-07771-12	FLT10770777012	FLT858101	FLT8801X
1093-07771-13	FLT10770777013	FLT858101	FLT8801X
1093-07868-01	FLT10770786701	FLT858101	FLT8801X
1093-07868-02	FLT10770786702	FLT858101	FLT8801X
1093-07868-03	FLT10770786703	FLT858101	FLT8801X
1093-07868-04	FLT10770786704	FLT858101	FLT8801X
1093-07868-05	FLT10770786705	FLT858101	FLT8801X
1093-07868-06	FLT10770786706	FLT858101	FLT8801X
1093-07868-07	FLT10770786707	FLT858101	FLT8801X
1093-07868-08	FLT10770786708	FLT858101	FLT8801X
1093-07868-09	FLT10770786709	FLT858101	FLT8801X
1093-07868-10	FLT10770786710	FLT858101	FLT8801X
1093-07868-11	FLT10770786711	FLT858101	FLT8801X
1093-07868-12	FLT10770786712	FLT858101	FLT8801X
1093-07870-01	FLT10770786901	FLT858101	FLT8801X
1093-07870-02	FLT10770786902	FLT858101	FLT8801X
1093-07870-03	FLT10770786903	FLT858101	FLT8801X
1093-07870-04	FLT10770786904	FLT858101	FLT8801X
1093-07896-01	FLT10770789501	FLT858101	FLT8801X
1093-07896-02	FLT10770789502	FLT858101	FLT8801X
1093-07896-03	FLT10770789503	FLT858101	FLT8801X
1093-07896-04	FLT10770789504	FLT858101	FLT8801X
1093-07896-05	FLT10770789505	FLT858101	FLT8801X
1093-07896-06	FLT10770789506	FLT858101	FLT8801X
1093-07896-07	FLT10770789507	FLT858101	FLT8801X
1093-07896-08	FLT10770789508	FLT858101	FLT8801X
1093-07896-09	FLT10770789509	FLT858101	FLT8801X
1093-07896-10	FLT10770789510	FLT858101	FLT8801X
1093-07900-01	FLT10770789901	FLT858201	FLT8801X
1093-07900-02	FLT10770789902	FLT858201	FLT8801X
1093-07900-03	FLT10770789903	FLT858201	FLT8801X
1093-07904-0			

OEM Part #		Fleetrite Part #	
Hub & Clutch Assy. Part #	Hub Only Part #	Hub Bearing Kit	Reman Fan Clutch #
1093-09125-02	FLT10770912402	FLT858202	FLT8801X
1093-09125-03	FLT10770912403	FLT858202	FLT8801X
1093-09125-04	FLT10770912404	FLT858202	FLT8801X
1093-09127-01	FLT10770912601	FLT858101	FLT8801X
1093-09127-04	FLT10770912604	FLT858101	FLT8801X
1093-09127-05	FLT10770912605	FLT858101	FLT8801X
1093-09127-06	FLT10770912606	FLT858101	FLT8801X
1093-09129-01	FLT10770912801	FLT858202	FLT8801X
1093-09129-02	FLT10770912802	FLT858101	FLT8801X
1093-09129-03	FLT10770912803	FLT858201	FLT8801X
1093-09129-04	FLT10770912804	FLT858201	FLT8801X
1093-09129-09	FLT10770912809	FLT858101	FLT8801X
1093-09129-10	FLT10770912810	FLT858101	FLT8801X
1093-09129-12	FLT10770912812	FLT858101	FLT8801X
1093-09132-01	FLT10770913101	FLT858101	FLT8801X
1093-09160-01	FLT10770915901	FLT858101	FLT8801X
1093-09160-02	FLT10770915902	FLT858101	FLT8801X
1093-09163-01	FLT10770916201	FLT858101	FLT8801X
1093-09173-01	FLT10770917201	FLT858201	FLT8801X
1093-09177-01	FLT10770917601	FLT858201	FLT8801X
1093-09177-02	FLT10770917602	FLT858201	FLT8801X
1093-09177-03	FLT10770917603	FLT858201	FLT8801X
1093-09177-04	FLT10770917604	FLT858101	FLT8801X
1093-09177-06	FLT10770917606	FLT858101	FLT8801X
1093-09180-01	FLT10770917901	FLT858101	FLT8801X
1093-09189-01	FLT10770918801	FLT858101	FLT8801X
1093-09189-02	FLT10770918802	FLT858101	FLT8801X
1093-09189-03	FLT10770918803	FLT858101	FLT8801X
1093-09193-01	FLT10770919201	FLT858101	FLT8801X
1093-09208-01	FLT10770920701	FLT858101	FLT8802X
1093-09210-0	FLT10770920902	FLT858101	FLT8801X
1093-09210-01	FLT10770920901	FLT858101	FLT8801X
1093-09213-01	FLT10770921201	FLT858101	FLT8801X

OEM Part #		Fleetrite Part #	
Hub & Clutch Assy. Part #	Hub Only Part #	Hub Bearing Kit	Reman Fan Clutch #
1093-09215-01	FLT10770921401	FLT858101	FLT8801X
1093-09219-01	FLT10770921801	FLT858101	FLT8801X
1093-09219-02	FLT10770921802	FLT858101	FLT8801X
1093-09221-01	FLT10770922001	FLT858101	FLT8801X
1093-09221-02	FLT10770922002	FLT858101	FLT8801X
1093-09224-01	FLT10770922301	FLT858201	FLT8801X
1293-09173-02	FLT10770917202	FLT858101	FLT8801X
1293-09215-02	FLT10770921402	FLT858101	FLT8801X
1293-09242-01	FLT10770924101	FLT858101	FLT8801X
1293-09247-01	FLT10770924601	FLT858101	FLT8801X
1293-09248-01	FLT10770924701	FLT858101	FLT8801X
1293-09253-01	FLT10770925201B	FLT858101	FLT8801X
1293-09253-02	FLT10770925202B	FLT858101	FLT8801X
1293-09256-01	FLT10770925501	FLT858101	FLT8801X
1293-09256-02	FLT10770925502	FLT858101	FLT8801X
1293-09262-01	FLT10770926101	FLT858101	FLT8801X
1293-09262-02	FLT10770926102	FLT858101	FLT8801X
1293-09262-03	FLT10770926103	FLT858101	FLT8801X
1293-09270-01	FLT010020392	FLT858101	FLT8801X
1293-09272-01	FLT10770927101	FLT858101	FLT8801X
1293-09274-01	FLT10770927301	FLT858101	FLT8801X
1293-09276-01	FLT10770927501	FLT858101	FLT8801X
1293-09278-01	FLT10770927701	FLT858101	FLT8801X
1293-09280-01	FLT10770927901	FLT858202	FLT8801X
1293-09282-01	FLT10770928101	FLT858101	FLT8801X
1293-09284-01	FLT10770928301	FLT858101	FLT8801X
1293-09288-01	FLT10770928701	FLT858101	FLT8801X
1293-09290-01	FLT10770928901	FLT858101	FLT8801X
1293-09292-01	FLT10770929101	FLT858101	FLT8801X
1293-09295-01	FLT10770929401	FLT858101	FLT8801X
1293-09298-01	FLT10770929701	FLT858101	FLT8801X
1293-09300-01	FLT10770929901	FLT858101	FLT8801X
1293-09302-01	FLT10770930101	FLT858101	FLT8801X

OEM Part #		Fleetrite Part #	
Hub & Clutch Assy. Part #	Hub Only Part #	Hub Bearing Kit	Reman Fan Clutch #
1293-09304-01	FLT10770930301	FLT858101	FLT8801X
1293-09304-02	FLT10770930302	FLT858101	FLT8801X
1293-09304-03	FLT10770930303	FLT858101	FLT8801X
1293-09304-04	FLT10770930304	FLT858101	FLT8801X
1293-09304-05	FLT10770930305	FLT858101	FLT8801X
1293-09304-06	FLT10770930306	FLT858101	FLT8801X
1293-09304-07	FLT10770930307	FLT858101	FLT8801X
1293-09304-08	FLT10770930308	FLT858101	FLT8801X
1293-09304-09	FLT10770930309	FLT858101	FLT8801X
1293-09304-10	FLT10770930310	FLT858101	FLT8801X
1293-09309-02	FLT10770930802	FLT858101	FLT8801X
1293-09311-01	FLT10770931001	FLT858101	FLT8801X
1293-09314-01	FLT10770931301	FLT858101	FLT8801X
1293-09316-01	FLT10770931501	FLT858101	FLT8801X
1293-09318-01	FLT10770931701	FLT858101	FLT8801X
1293-09320-01	FLT10770931901	FLT858202	FLT8801X
1293-09323-01	FLT10770932201	FLT858101	FLT8801X
1293-09324-01	FLT10770932301	FLT858101	FLT8801X
1293-09330-01	FLT10770932901	FLT858201	FLT8801X
1293-09334-01	FLT10770933301	FLT858201	FLT8801X
1293-09334-01B	FLT10770933501B	FLT858201	FLT8801X
1293-09339-01	FLT10770933801B	FLT858201	FLT8801X
1293-09344-01	FLT10770934301	FLT858101	FLT8801X
1293-09348-01	FLT10770934701	FLT858201	FLT8801X
1293-09352-01	FLT10770935101	FLT858101	FLT8801X
1293-09355-01	FLT10770935401	FLT858101	FLT8801X
1293-09355-02	FLT10770935402	FLT858101	FLT8801X
1293-09360-01	FLT10770935901	FLT858101	FLT8801X
1293-09362-01	FLT10770936101	FLT858101	FLT8801X
1293-09364-01	FLT10770936301	FLT858101	FLT8801X
1293-09370-01	FLT10770936901	FLT858101	FLT8801X
1293-09370-02	FLT10770936902	FLT858101	FLT8801X
1293-09374-01	FLT10770937301	FLT858101	FLT8801X

FAN BLADES

OEM Part #	Fleetrite Part #
ACS	
002256-28	FLT010021062
002256-28.5	FLT4400002
002500-30	FLT010020940
003256-30	FLT4400314
003256-31	FLT4400313
003256-32	FLT4400301
003500-30	FLT4400316
134200-24	FLT4113432
134200-28	FLT4113406
134200-29.5	FLT4113469
134200-30	FLT4113402
134200-31	FLT4113468
134200-32	FLT4113441
134256-24	FLT4113433
134256-26	FLT4113419
134256-27	FLT4113471
134256-28	FLT4113405
134256-29.5	FLT4113470
134256-30	FLT4113401
134256-31	FLT4113446
134256-32	FLT4113442
134500-24	FLT4113435
134500-25	FLT4113439
134500-26	FLT4113421
134500-28	FLT4113424
134500-29.5	FLT4113449
134500-30	FLT4113413
134500-31	FLT4113447
134500-32	FLT4113443
135200-23	FLT4113546

OEM Part #	Fleetrite Part #
135200-24	FLT4113541
135200-25	FLT4113536
135200-26	FLT4113531
135200-27	FLT4113526
135200-28	FLT4113522
135200-29	FLT4113503
135200-29.5	FLT4113518
135200-30	FLT4113502
135200-31	FLT4113511
135200-32	FLT4113507
135200-34	FLT4289031
135200-36	FLT4289021
135200-38	FLT4289011
135256-23	FLT4113547
135256-24	FLT4113542
135256-25	FLT4113537
135256-26	FLT4113532
135256-27	FLT4113527
135256-28	FLT4113505
135256-29	FLT4113504
135256-29.5	FLT4113566
135256-30	FLT4113501
135256-31	FLT4113512
135256-32	FLT4113508
135256-34	FLT4289032
135256-36	FLT4289022
135256-38	FLT4289012
135500-24	FLT4113544
135500-25	FLT4113539
135500-26	FLT4113534
135500-27	FLT4113529

OEM Part #	Fleetrite Part #
135500-28	FLT4113524
135500-29	FLT4113520
135500-29.5	FLT4113568
135500-30	FLT4113516
135500-31	FLT4113513
135500-32	FLT4113509
135500-34	FLT4289035
135500-36	FLT4289025
135500-38	FLT4289015
296200-22	FLT4129676
296200-23	FLT4129683
296200-24	FLT4129689
296200-24.5	FLT41296134
296200-26	FLT4129610
296200-27	FLT41296106
296200-27.5	FLT41296138
296200-28	FLT4129605
296256-28	FLT41296112
391200-22	FLT4139151
391200-28	FLT4139122
391200-30	FLT4139102
391200-32	FLT4139107
391256-22	FLT4139152
391256-25	FLT4139137
391256-26	FLT4139132
391256-28	FLT4139105
391256-29	FLT4139104
391256-30	FLT4139101
391256-31	FLT4139112
391256-32	FLT4139108
391500-24	FLT4139144

OEM Part #	Fleetrite Part #
391500-25	FLT4139139
391500-26	FLT4139134
391500-27	FLT4139129
391500-28	FLT4139124
391500-29	FLT4139120
391500-29.5	FLT4139158
391500-30	FLT4139116
391500-32	FLT4139109
392200-22	FLT4139251
392200-23	FLT4139246
392200-24	FLT4139241
392200-25	FLT4139236
392200-26	FLT4139231
392200-27	FLT4139226
392200-27	FLT4378214
392200-28	FLT4139222
392200-28.5	FLT4139260
392200-29	FLT4344014
392200-30	FLT4139202
392200-31	FLT4139211
392200-31.5	FLT4139286
392200-32	FLT4139207
392256-22	FLT4378216
392256-23	FLT4139247
392256-25	FLT4139237
392256-26	FLT4139232
392256-27	FLT4139227
392256-28	FLT4139205
392256-28.5	FLT4139295
392256-29	FLT4139204
392256-29.5	FLT41392113

OEM Part #	Fleetrite Part #
392256-30	FLT4139201
392256-31	FLT4344005
392256-32	FLT4139208
392256-24	FLT4139242
392500-22	FLT4139254
392500-23	FLT4378218
392500-24	FLT4139244
392500-25	FLT4139239
392500-26	FLT4139234
392500-27	FLT4139229
392500-28	FLT4139224
392500-29	FLT4139220
392500-29.5	FLT4139258
392500-30	FLT4139216
392500-31	FLT4344007
392500-32	FLT4139209
393200-22	FLT4139351
393200-24	FLT4139341
393200-25	FLT4139336
393200-26	FLT4139331
393200-26.5	FLT4139368
393200-28	FLT4139322
393200-29	FLT4139303
393200-30	FLT4139302
393200-31	FLT4139311
393200-31.5	FLT4139386
393200-32	FLT4139307
393256-22	FLT4139352
393256-24	FLT4139342
393256-26	FLT4139332
393256-27	FLT4139327
393256-28	FLT4139305
393256-28.5	FLT4139361
393256-29	FLT4139304
393256-29.5	FLT4139317
393256-30	FLT4139301
393256-31	FLT4139312
393256-32	FLT4139308
393500-22	FLT4139354
393500-24	FLT4139344
393500-24.5	FLT4139311
393500-25	FLT4139339
393500-26	FLT4139334
393500-26	FLT4378310
393500-27	FLT4139329
393500-27.5	FLT4139390
393500-28	FLT4139324
393500-29	FLT4139320
393500-29.5	FLT4139358
393500-30	FLT139316
393500-31	FLT4139313
393500-32	FLT139309
439200-30	FLT4211102
439200-32	FLT4211107
439256-24	FLT4149509
439256-25	FLT4149510
439256-26	FLT4149508
439256-28.5	FLT4149501
439256-30	FLT4211109
439256-32	FLT4211108
439500-28.5	FLT4149503
440200-30	FLT4211202
440200-32	FLT4211207
440256-24	FLT4149809
440256-25	FLT4149810
440256-26	FLT4149808
440256-28.5	FLT4211261

OEM Part #	Fleetrite Part #
440256-30	FLT4211201
440256-31	FLT4211212
440256-32	FLT4211209
440500-26	FLT4149807
441256-24	FLT4051807
441256-26	FLT4149708
441256-28.5	FLT4149701
441500-24	FLT4051805
441500-26	FLT4149707
441500-28.5	FLT4149703
444200-20	FLT4336852
444200-21	FLT4336844
444200-22	FLT4336839
444200-23	FLT4336833
444200-24	FLT4336827
444200-25	FLT4336820
444200-26	FLT4336802
444256-20	FLT4336851
444256-21	FLT4336843
444256-22	FLT4336838
444256-23	FLT4336832
444256-24	FLT4336826
444256-25	FLT4336819
444256-26	FLT4336801
444500-20	FLT4336854
444500-21	FLT4336846
444500-22	FLT4336808
444500-23	FLT4336809
444500-24	FLT4336829
444500-25	FLT4336822
444500-26	FLT4336803
445200-22	FLT4262351
445200-23	FLT4262346
445200-24	FLT4262341
445200-25	FLT4262336
445200-26	FLT4262331
445200-26.5	FLT4262368
445200-27	FLT4262326
445200-28	FLT4262322
445200-28.5	FLT4262360
445200-29	FLT4262303
445200-29.5	FLT4262318
445200-30	FLT4262302
445200-31	FLT4262311
445200-31.5	FLT4262386
445200-32	FLT4262307
445200-34	FLT4262351
445200-36	FLT42623502
445205-28	FLT4262381
445205-30	FLT4262384
445205-31	FLT42623100
445205-32	FLT4262387
445205-36	FLT42623503
445256-22	FLT4262352
445256-23	FLT4262347
445256-24	FLT4262342
445256-25	FLT4262337
445256-26	FLT4262332
445256-27	FLT4262327
445256-28	FLT4262305
445256-28.5	FLT4262361
445256-29	FLT4262304
445256-29.5	FLT4262356
445256-30	FLT4262301
445256-31	FLT4262312
445256-31.5	FLT4262399
445256-32	FLT4262308

OEM Part #	Fleetrite Part #
445256-34	FLT42623512
445256-36	FLT42623505
445500-22	FLT4262354
445500-23	FLT4262349
445500-24	FLT4262344
445500-25	FLT4262339
445500-26	FLT4262334
445500-27	FLT4262329
445500-28	FLT4262324
445500-28.5	FLT4262363
445500-29	FLT4262320
445500-29.5	FLT4262358
445500-30	FLT4262316
445500-31	FLT4262313
445500-32	FLT4262309
445500-36	FLT42623510
449200-16	FLT3844932
449200-18	FLT3844942
449200-19	FLT3844947
449200-20	FLT3844908
449200-21	FLT3844923
449200-22	FLT3844909
449200-23	FLT4260058
449200-26	FLT4260070
449200-29	FLT4260099
449256-16	FLT3844934
449256-17	FLT3844940
449256-20	FLT3844952
449256-22	FLT3844905
449256-24	FLT4260038
449256-26	FLT4260028
449256-28	FLT4260018
449256-29	FLT4260056
449256-30	FLT4260005
449500-20	FLT38449105
449500-22	FLT38449104
449500-24	FLT4260041
449500-25	FLT42600102
449500-29	FLT4260057
449500-30	FLT4260008
828200-18	FLT3582877
828200-20	FLT3582863
828200-22	FLT3582868
828200-23	FLT3582831
828200-24	FLT3582819
828200-26	FLT3582814
828200-28	FLT3582836
828200-30	FLT3582832
828200-31.5	FLT35828125
828200-32	FLT3582834
828200-33	FLT35828123
828200-34	FLT3582835
828200-36	FLT3582830
828205-22	FLT3582818
828205-24	FLT3582824
828205-26	FLT35828105
828205-28	FLT3582895
828205-30	FLT3582897
828205-32	FLT3582808
828205-34	FLT3582848
828205-36	FLT3582803
828256-20	FLT3582881
828256-22	FLT3582886
828256-24	FLT3582816
828256-26	FLT3582815
828256-28	FLT3582812
828256-30	FLT3582813

OEM Part #	Fleetrite Part #
828256-32	FLT3582807
828256-34	FLT3582860
828256-36	FLT3582806
828500-22	FLT3582888
828500-24	FLT3582891
828500-26	FLT3582894
828500-28	FLT3582817
828500-30	FLT3582899
828500-32	FLT3582837
828501-25.5	FLT35828109
904200-23	FLT3816424
904200-24	FLT4290433
904200-25	FLT4290477
904200-26	FLT4290424
904200-28	FLT4290406
904200-29	FLT4343974
904200-30	FLT4290404
904200-31	FLT42904101
904200-32	FLT4290402
904256-23	FLT4290436
904256-24	FLT4290422
904256-25	FLT4290425
904256-26	FLT4290418
904256-27	FLT3816479
904256-27.5	FLT3816487
904256-28	FLT4290409
904256-29	FLT4290470
904256-30	FLT4290408
904256-32	FLT4290407
904500-22	FLT4290498
904500-23	FLT3816417
904500-23.5	FLT4290499
904500-24	FLT4290431
904500-25	FLT3816468
904500-26	FLT4290415
904500-27	FLT3816477
904500-28	FLT4290428
904500-29	FLT42904102
904500-30	FLT4290419
904500-32	FLT4290410
CUMMINS	
3039527	FLT3582814
3099530	FLT41392113
3099556	FLT4139204
3099557	FLT4139205
3099558	FLT4139304
3099559	FLT4139305
3283345	FLT35828179
3328436	FLT3882559
3415030	FLT4139208
3415031	FLT4139308
3415038	FLT4139201
3415039	FLT4139301
3910373	FLT3844927
3911316	FLT3582852
3911317	FLT3582842
3911318	FLT3582843
3911319	FLT3882531
3911320	FLT3582844
3911321	FLT3882540
3911322	FLT3582845
3911323	FLT3882551
3911324	FLT3582853
3911325	FLT3882558
3911326	FLT3582854
3911327	FLT3882564
3911328	FLT3582855

OEM Part #	Fleetrite Part #
3912750	FLT3844919
3912751	FLT3844903
3912752	FLT3844921
3912753	FLT3844906
3930238	FLT3882581
3930239	FLT3882582
3930241	FLT3844942
3930242	FLT3844908
3930243	FLT3844909
3931028	FLT4113540
10000336	FLT4129661
11000280	FLT3548094
11000281	FLT3582845
11000282	FLT4113506
11000283	FLT3582855
11000286	FLT3548085
11000310	FLT4113507
11000311	FLT3582834
11000338	FLT38449129
11000342	FLT3816430
33912751	FLT3844903
C0130360900	FLT3844926
FORD	
94HA-8600-AA	FLT4139201
E4HS-8600-DA	FLT3548019
E4HS-8600-FA	FLT3548010
E6HS-8600-CA	FLT3816414
E7HS-8600-BA	FLT3816407
E8HS-8600-AA	FLT3858507
E8HS-8600-BA	FLT3548015
E8HS-8600-CA	FLT3882511
E8HS-8600-DA	FLT3548010
E8HS-8600-EA	FLT3882510
E8HS-8600-FA	FLT3548007
E8HT-8600-FA	FLT3816412
E8HT-8600-FB	FLT3816476
E8HT-8600-HA	FLT3816476
E8HT-8600-JA	FLT4051804
E8HT-8600-NA	FLT3816414
E8HT-8600-RA	FLT3816477
E8HT-8600-SA	FLT3816479
E8HZ-8600-B	FLT3816412
E8HZ-8600-C	FLT3816476
E8HZ-8600-J	FLT3816479
E9HS-8600-A	FLT4343969
E9HS-8600-CA	FLT3882574
E9HZ-8600-A	FLT4051804
E8HZ-8600-B	FLT3816477
FOHT-8600-AA	FLT4051805
FOHT-8600-BA	FLT3548007
FOHT-8600-DA	FLT3548010
FOHZ-8600-A	FLT3548007
FOHZ-8600-B	FLT3548010
FOHZ-8600-C	FLT4051805
FOHZ-8600-D	FLT3882511
FOHZ-8600-E	FLT3882574
F1HS-8600-A	FLT3882577
F1HT-8600-KA	FLT4149501
F1HT-8600-LA	FLT4149701
F1HT-8600-MA	FLT4149703
F1HT-8600-NA	FLT4149801
F1HT-8600-RA	FLT4051806
F1HT-8600-SA	FLT4051804
F1HT-8600-TA	FLT4051805
F1HZ-8600-D	FLT4051805
F1HZ-8600-E	FLT4051804
F1HZ-8600-F	FLT4149801

OEM Part #	Fleetrite Part #
F1HZ-8600-H	FLT4149701
F1HZ-8600-J	FLT4149703
F1HZ-8600-K	FLT4149501
F1HZ-8600-L	FLT4051806
F2HS-8600-AA	FLT4149509
F2HT-8600-AA	FLT4139329
F2HT-8600-BA	FLT4139339
F2HT-8600-CA	FLT4139229
F2HZ-8600-A	FLT4139329
F2HZ-8600-B	FLT4139339
F2HZ-8600-C	FLT4139229
F3HS-8600-BA	FLT4149809
F3HS-8600-CA	FLT4149810
F3HT-8600-CA	FLT4149707
F3HT-8600-DA	FLT4149708
F3HT-8600-EA	FLT4149508
F3HT-8600-FA	FLT4149808
F3HZ-8600-A	FLT4149707
F3HZ-8600-B	FLT4149808
F3HZ-8600-DA	FLT4149708
F4HS-8600-AA	FLT4149503
F4HZ-8600-A	FLT4139301
F4HZ-8600-B	FLT4211201
F4HZ-8600-D	FLT4149811
F4HZ-8600-E	FLT4149711
F5HS-8600-BA	FLT4051807
F5HT-8600-AA	FLT4149811
F5HT-8600-BA	FLT4149711
F5HZ-8600-AA	FLT4149811
F5HZ-8600-BA	FLT4149711
F5HZ-8600-BAA	FLT4051807
F6HT-8600-AA	FLT4149812
F6HT-8600-FA	FLT4149812
F6HZ-8600-A	FLT4149812
F7HT-8600-EA	FLT4333001
F7HT-8600-FA	FLT4333103
F7HT-8600-GA	FLT4333011
F7HT-8600-HA	FLT4333101
F7HT-8600-JA	FLT4332901
F7HZ-8600-EA	FLT4333001
F7HZ-8600-FA	FLT4333103
F7HZ-8600-GA	FLT4333011
F7HZ-8600-HA	FLT4333101
F7HZ-8600-JA	FLT4332901
F8HZ-8600-AA	FLT4211212
IC44-8600-AA	FLT4378310
XC35-8600-CA	FLT38449124
XC45-8600-BA	FLT4149807
XC45-8600-DA	FLT4321703
YC35-8600-CA	FLT4348029
FREIGHTLINER	
680-200-01-23	FLT3548021
680-200-02-23	FLT3548031
681-200-00-23	FLT3882501
681-200-01-23	FLT3882509
681-200-02-23	FLT4343919
681-200-03-23	FLT3882505
681-200-04-23	FLT3858502
681-200-05-23	FLT3816407
681-205-02-06	FLT3816409
LM685-200-10-23	FLT4262222
LM685-200-14-23	FLT3582812
GM	
15026756	FLT4139334
15026757	FLT4139311
15094861	FLT4348003
15987287	FLT4260031

OEM Part #	Fleetrite Part #
HORTON®	
981660202	FLT4139231
981660203	FLT4139331
981660251	FLT4139132
981660252	FLT4139232
981660253	FLT4139332
981660501	FLT4139134
981660502	FLT4139234
981660503	FLT4139334
981680202	FLT4139231
981680203	FLT4139397
981680251	FLT4139132
981680252	FLT4139232
981680253	FLT4139332
981680501	FLT4139134
981680502	FLT4139234
981680503	FLT4139334
981686202	FLT4139226
981686203	FLT4139397
981686252	FLT4139227
981686253	FLT4139327
981686501	FLT4139129
981686502	FLT4139229
981686503	FLT4139329
981700202	FLT4139226
981700252	FLT4139227
981700253	FLT4139327
981700501	FLT4139190
981700502	FLT4139290
981700503	FLT4139390
981711201	FLT4139122
981711202	FLT4139222
981711203	FLT4139322
981711251	FLT4139105
981711252	FLT4139205
981711253	FLT4139305
981711501	FLT4139124
981711502	FLT4139224
981711503	FLT4139324
981737502	FLT4139220
981750203	FLT4139303
981750251	FLT4139104
981750252	FLT41392113
981750253	FLT41393117
981750501	FLT4139258
981750502	FLT4139258
981750503	FLT4139358
981762201	FLT4139102
981762202	FLT4139202
981762203	FLT4139302
981762251	FLT4139101
981762252	FLT4139201
981762253	FLT4139301
981762501	FLT4139116
981762502	FLT4139216
981762503	FLT139316
981787202	FLT4139211
981787203	FLT4139311
981787251	FLT4139112
981787252	FLT4139212
981787253	FLT4139312
981787503	FLT4139313
981800202	FLT4139286
981800203	FLT4139386
981800251	FLT4139112
981800252	FLT4139212
981800253	FLT41393121

OEM Part #	Fleetrite Part #
981800503	FLT4139313
981813201	FLT4139107
981813202	FLT4139207
981813203	FLT4139307
981813251	FLT4139108
981813252	FLT4139208
981813253	FLT4139308
981813501	FLT4139109
981813502	FLT4139209
981813503	FLT139309
982660252	FLT4149808
982660253	FLT4149708
982660502	FLT4149807
982660503	FLT4149707
982724252	FLT4149801
985559503	FLT4139354
985600503	FLT4139392
985610101	FLT4139140
985610102	FLT4139340
985610202	FLT4139241
985610203	FLT4139341
985610252	FLT4139242
985610253	FLT4139244
985610503	FLT4139344
985620102	FLT4139240
985620503	FLT41393111
985660102	FLT41392105
985660103	FLT4139330
985660202	FLT4139231
985660203	FLT4139331
985660251	FLT4139132
985660253	FLT4139332
985660501	FLT4139134
985660503	FLT4139334
985686203	FLT4139368
985686252	FLT4139227
985686253	FLT4139327
985686501	FLT4139129
985686502	FLT4139229
985686503	FLT4139329
985700102	FLT4139225
985700202	FLT4139226
985700252	FLT4139227
985700253	FLT4139327
985700501	FLT4139190
985700502	FLT4139290
985700503	FLT4139390
985711101	FLT4139121
985711102	FLT4139221
985711103	FLT4139321
985711201	FLT4139122
985711202	FLT4139222
985711203	FLT4139322
985711251	FLT4139105
985711252	FLT4139205
985711253	FLT4139305
985711501	FLT4139124
985711502	FLT4139224
985711503	FLT4139324
985750203	FLT4139303
985750252	FLT41392113
985750253	FLT41393117
985750501	FLT4139258
985750502	FLT4139258
985750503	FLT4139358
985750502	FLT4139258
985750503	FLT4139358
985762101	FLT4139114
985762102	FLT4139214

OEM Part #	Fleetrite Part #	OEM Part #	Fleetrite Part #	OEM Part #	Fleetrite Part #	OEM Part #	Fleetrite Part #
985762103	FLT4139314	988711252	FLT4262205	991711501	FLT4139124	995686253	FLT4139327
985762201	FLT4139102	988711253	FLT4262305	991711502	FLT4139224	995686501	FLT4139129
985762202	FLT4139202	988711253	FLT4262305	991711503	FLT4139324	995686502	FLT4139229
985762203	FLT4139302	988711501	FLT4262124	991737502	FLT4139220	995686503	FLT4139329
985762251	FLT4139101	988711501	FLT4262124	991750203	FLT4139303	995700102	FLT4139225
985762252	FLT4139201	988711502	FLT4262224	991750251	FLT4139104	995700202	FLT4139226
985762253	FLT4139301	988711503	FLT4262324	991750252	FLT4139213	995700252	FLT4139227
985762501	FLT4139116	988720502	FLT4262263	991750253	FLT41393117	995700253	FLT4139327
985762502	FLT4139216	988750101	FLT4262155	991750501	FLT4139258	995700501	FLT4139190
985762503	FLT139316	988750102	FLT4262255	991750502	FLT4139258	995700502	FLT4139290
986813252	FLT010023824	988750103	FLT4262355	991750503	FLT4139358	995700503	FLT4139390
986813502	FLT4400010	988750201	FLT4262118	991762201	FLT4139102	995711101	FLT4139121
986813502-002	FLT4400010	988750202	FLT4262218	991762202	FLT4139202	995711102	FLT4139221
988559502	FLT4262254	988750203	FLT4262318	991762203	FLT4139302	995711103	FLT4139321
988600253	FLT4262347	988750251	FLT4262156	991762251	FLT4139101	995711201	FLT4139122
988610101	FLT4262140	988750252	FLT4262256	991762252	FLT4139201	995711202	FLT4139222
988610102	FLT4262240	988750253	FLT4262356	991762253	FLT4139301	995711203	FLT4139322
988610103	FLT4262340	988750501	FLT4262158	991762501	FLT4139116	995711251	FLT4139105
988610202	FLT4262241	988750502	FLT4262258	991762502	FLT4139216	995711252	FLT4139205
988610203	FLT4262241	988750503	FLT4262358	991762503	FLT139316	995711253	FLT4139305
988610251	FLT4262142	988762101	FLT4262114	991787202	FLT4139211	995711501	FLT4139124
988610252	FLT4262242	988762102	FLT4262214	991787203	FLT4139311	995711502	FLT4139224
988610253	FLT4262342	988762103	FLT4262314	991787251	FLT4139112	995711503	FLT4139324
988610501	FLT4262144	988762201	FLT4262102	991787252	FLT4139212	995750203	FLT4139303
988610502	FLT4262244	988762202	FLT4262202	991787253	FLT4139312	995750252	FLT4139213
988610503	FLT4262344	988762203	FLT4262302	991787503	FLT4139313	995750253	FLT4139317
988620102	FLT4262240	988762251	FLT4262101	991800202	FLT4139286	995750501	FLT4139158
988660101	FLT4262130	988762252	FLT4262201	991800203	FLT4139386	995750502	FLT4139258
988660103	FLT4262330	988762253	FLT4262301	991800251	FLT4139112	995750503	FLT4139358
988660201	FLT4262131	988762501	FLT4262116	991800252	FLT4139212	995762101	FLT4139114
988660202	FLT4262231	988762502	FLT4262216	991800253	FLT41393121	995762102	FLT4139214
988660203	FLT4262331	988762503	FLT4262316	991800503	FLT4139313	995762103	FLT4139314
988660251	FLT4262132	991660202	FLT4139231	991813201	FLT4139107	995762201	FLT4139102
988660252	FLT4262232	991660203	FLT4139331	991813202	FLT4139207	995762202	FLT4139202
988660253	FLT4262332	991660251	FLT4139132	991813203	FLT4139307	995762203	FLT4139302
988660501	FLT4262134	991660252	FLT4139232	991813251	FLT4139108	995762251	FLT4139101
988660502	FLT4262234	991660253	FLT4139332	991813252	FLT4139208	995762252	FLT4139201
988660503	FLT4262334	991660501	FLT4139134	991813253	FLT4139308	995762253	FLT4139301
988686101	FLT4262125	991660502	FLT4139234	991813501	FLT4139109	995762501	FLT4139116
988686102	FLT4262225	991660503	FLT4139334	991813502	FLT4139209	995762502	FLT4139216
988686103	FLT4262325	991680202	FLT4139231	991813503	FLT139309	995762503	FLT139316
988686201	FLT4262126	991680203	FLT4139397	992660252	FLT4149808	996813252	FLT010023824
988686202	FLT4262226	991680251	FLT4139132	992660253	FLT4149708	996813502	FLT4400010
988686203	FLT4262326	991680252	FLT4139232	992660502	FLT4149807	996813502-002	FLT4400010
988686251	FLT4262127	991680253	FLT4139332	992660503	FLT4149707	998559502	FLT4262254
988686252	FLT4262227	991680501	FLT4139134	992724252	FLT4149801	998600253	FLT4262347
988686253	FLT4262327	991680502	FLT4139234	995559503	FLT4139354	998610101	FLT4262140
988686501	FLT4262129	991680503	FLT4139334	995600503	FLT4139392	998610102	FLT4262240
988686502	FLT4262229	991686202	FLT4139226	995610101	FLT4139140	998610103	FLT4262340
988686503	FLT4262329	991686203	FLT4139397	995610102	FLT4139340	998610202	FLT4262241
988700101	FLT4262125	991686252	FLT4139227	995610202	FLT4139241	998610203	FLT4262241
988700102	FLT4262225	991686253	FLT4139327	995610203	FLT4139341	998610251	FLT4262142
988700103	FLT4262325	991686501	FLT4139129	995610252	FLT4139242	998610252	FLT4262242
988700201	FLT4262126	991686502	FLT4139229	995610253	FLT4139242	998610253	FLT4262342
988700202	FLT4262218	991686503	FLT4139329	995610503	FLT4139344	998610501	FLT4262144
988700203	FLT4262326	991700202	FLT4139226	995620102	FLT4139240	998610502	FLT4262244
988700253	FLT4262327	991700252	FLT4139227	995620503	FLT4139311	998610503	FLT4262344
988700501	FLT4262190	991700253	FLT4139327	995660102	FLT41392105	998620102	FLT4262240
988700502	FLT4262290	991700501	FLT4139190	995660103	FLT4139330	998660101	FLT4262130
988700503	FLT4262390	991700502	FLT4139290	995660202	FLT4139231	998660103	FLT4262330
988711101	FLT4262121	991700503	FLT4139390	995660203	FLT4139331	998660201	FLT4262131
988711102	FLT4262221	991711201	FLT4139122	995660251	FLT4139132	998660202	FLT4262231
988711103	FLT4262321	991711202	FLT4139222	995660253	FLT4139332	998660203	FLT4262331
988711201	FLT4262122	991711203	FLT4139322	995660501	FLT4139134	998660251	FLT4262132
988711202	FLT4262222	991711251	FLT4139105	995660503	FLT4139334	998660252	FLT4262232
988711203	FLT4262322	991711252	FLT4139205	995686203	FLT4139368	998660253	FLT4262332
988711252	FLT4262205	991711253	FLT4139305	995686252	FLT4139227	998660501	FLT4262134

OEM Part #	Fleetrite Part #
998660502	FLT4262234
998660503	FLT4262334
998686101	FLT4262125
998686102	FLT4262225
998686103	FLT4262325
998686201	FLT4262126
998686202	FLT4262226
998686203	FLT4262326
998686251	FLT4262127
998686252	FLT4262227
998686253	FLT4262327
998686501	FLT4262129
998686502	FLT4262229
998686503	FLT4262329
998700101	FLT4262125
998700102	FLT4262225
998700103	FLT4262325
998700201	FLT4262126
998700202	FLT42622118
998700203	FLT4262326
998700253	FLT4262327
998700501	FLT4262190
998700502	FLT4262290
998700503	FLT4262390
998711101	FLT4262121
998711102	FLT4262221
998711103	FLT4262321
998711201	FLT4262122
998711202	FLT4262222
998711203	FLT4262322
998711252	FLT4262205
998711252	FLT4262205
998711253	FLT4262305
998711253	FLT4262305
998711501	FLT4262124
998711501	FLT4262124
998711502	FLT4262224
998711503	FLT4262324
998720502	FLT4262263
998750101	FLT4262155
998750102	FLT4262255
998750103	FLT4262355
998750201	FLT4262118
998750202	FLT4262218
998750203	FLT4262318
998750251	FLT4262156
998750252	FLT4262256
998750253	FLT4262356
998750501	FLT4262158
998750502	FLT4262258
998750503	FLT4262358
998762101	FLT4262114
998762102	FLT4262214
998762103	FLT4262314
998762201	FLT4262102
998762202	FLT4262202
998762203	FLT4262302
998762251	FLT4262101
998762252	FLT4262201
998762253	FLT4262301
998762501	FLT4262116
998762502	FLT4262216
998762503	FLT4262316
981813502-001	FLT4139209
981813503-001	FLT139309
988711501-001	FLT4262124
991813502-001	FLT4139209

OEM Part #	Fleetrite Part #
991813503-001	FLT139309
998711501-001	FLT4262124
INTERNATIONAL	
0544734C1	FLT3548010
0547734C1	FLT3548010
0548509C1	FLT3548018
0548754C1	FLT3548031
0999882C1	FLT3548065
1515566C1	FLT3816401
1606826C1	FLT3548007
1606940C1	FLT3548006
1606948C1	FLT3548032
1607711C1	FLT4343905
1607967C1	FLT3548005
1609543C1	FLT3548028
1609630C1	FLT3548001
1609873C2	FLT3816412
1610797C1	FLT3548015
1610891C1	FLT3816448
1610891C2	FLT3816411
1611064C1	FLT3816414
1611610C1	FLT3858507
1611749C1	FLT4290407
1611853C1	FLT3816409
1611890C2	FLT3816407
1611912C1	FLT3816450
1614237C1	FLT3844905
1614238C1	FLT3548019
1614364C1	FLT3816440
1616224C1	FLT4290409
1619544C1	FLT3816447
1620103C1	FLT4290418
1620104C1	FLT4290436
1622571C1	FLT4139222
1666626C1	FLT3858502
1670050C1	FLT4290419
2000729C2	FLT139316
2002598C1	FLT4139232
2004743C1	FLT4139324
2004796C1	FLT4139305
2005452C1	FLT4139301
2010884C1	FLT4139302
2012329C1	FLT4139247
2018340C1	FLT4139224
2022048C91	FLT4139201
2022401C1	FLT4139216
2039347C1	FLT4139205
2503741C1	FLT3548065
2995331C1	FLT3582814
3505848C1	FLT4139209
3507212C1	FLT4139308
3507485C1	FLT4139313
3507486C1	FLT4139312
3583622C1	FLT4336803
3588999C1	FLT010019804
3594738C1	FLT4262309
3542182C2	FLT4378701
3625639C1	FLT4139308
MACK	
2MH357	FLT3548010
2MH358M	FLT3548005
2MH359M	FLT4343907
2MH421P2	FLT3882534
2MH437	FLT3548020
2MH439	FLT3548055
2MH440	FLT4343928
2MH443	FLT3882537

OEM Part #	Fleetrite Part #
2MH444	FLT4113532
2MH446	FLT4113534
2MH452	FLT4343901
2MH466	FLT4113534
2MH51	FLT4334044
2MH52P2	FLT4139332
2MH52P3	FLT4139308
2MH53	FLT4113572
PETERBILT	
05-13752-200	FLT4113441
05-14297-200	FLT4113402
05-14712-200	FLT4343902
05-14872-200	FLT4343904
05-15011-500	FLT4113443
05-15444-200	FLT3816406
05-15444-256	FLT3816407
05-15444-500	FLT3816409
05-17215-200	FLT4139231
05-17293-500	FLT4139334
05-17923-200	FLT4139331
05-17926-200	FLT4139302
05-17926-256	FLT4139301
05-17926-500	FLT139316
05-17927-200	FLT4139202
05-18010-200	FLT4139322
05-18010-500	FLT4139324
05-18895-100	FLT4113542
05-18895-256	FLT4113508
05-18918-200	FLT4139307
05-18918-256	FLT4139308
05-18934-200	FLT4113441
05-18934-256	FLT4113442
05-18934-500	FLT4113443
05-19052-200	FLT4139222
05-19052-500	FLT4139224
05-19142-200	FLT4139231
05-19142-500	FLT4139234
05-19204-100	FLT3548094
05-19204-500	FLT3548055
05-19223-200	FLT4139331
05-19313-200	FLT4139202
05-19317-256	FLT4290409
05-19451-500	FLT4139209
05-19476-200	FLT4290402
05-19476-256	FLT4290407
05-19615-200	FLT4139302
05-19615-256	FLT4139301
05-19615-500	FLT139316
05-19629-500	FLT3882501
05-19632-200	FLT4113441
05-19632-256	FLT4113442
05-19632-500	FLT4113443
05-19633-500	FLT4113421
05-19634-256	FLT4290409
05-19635-200	FLT4290404
05-19635-256	FLT4290408
05-19636-200	FLT4290402
05-19637-200	FLT4139222
05-19637-256	FLT4139205
05-19637-500	FLT4139224
05-19638-500	FLT4139234
05-19639-200	FLT4139307
05-19639-256	FLT4139308
05-19639-500	FLT139309
05-19640-200	FLT4139331
05-19640-500	FLT4139334
05-19641-200	FLT4139322

OEM Part #	Fleetrite Part #
05-19697-500	FLT4113413
05-19751-200	FLT4113507
05-19751-256	FLT4113508
05-19751-500	FLT4113509
05-19754-200	FLT4139207
05-19754-256	FLT4139208
05-19801-500	FLT4113516
05-19912-200	FLT4290424
05-19960-500	FLT4113513
VOLVO	
1938279	FLT3844906
1938433	FLT3582853
1938759	FLT3582897
1939440	FLT3882551
3081858	FLT4343909
3085042	FLT3816492
3086143	FLT4139205
3086602	FLT4343928
3159233	FLT4139212
3174796	FLT4139213
3919054	FLT3882510
3919689	FLT3816406
3933726	FLT4139222
3933727	FLT4260018
3937593	FLT4139202
3938147	FLT4139216
3940166	FLT4113501
3946053	FLT4290406
3967625	FLT4139312
3972009	FLT4139202
3972012	FLT4290410
3972013	FLT4290419
3972014	FLT4290402
3972015	FLT4290404
3972017	FLT4113507
3973704	FLT4290407
3973705	FLT4113508
3973733	FLT4290408
3973793	FLT4113441
3973794	FLT4113442
3973936	FLT4139301
3974048	FLT4139201
3974059	FLT41392103
3974060	FLT4139216
3974067	FLT4139204
3974068	FLT4139205
3974069	FLT4290409
15094861	FLT4348003
15518830	FLT4343908
15520859	FLT4343903
15520883	FLT4343907
15544949	FLT4343952
15592194	FLT4343946
15987287	FLT4260031
20801-0080	FLT3548003
20801-0081	FLT4343907
20801-0082	FLT4343902
20801-0083	FLT4343933
20801-0084	FLT3548027
20801-0085	FLT3548010
20801-0086	FLT3548018
20801-0087	FLT4343901
20801-0089	FLT3548032
20801-0092	FLT4343922
20801-0095	FLT3816454
20801-0096	FLT3816451
20801-0097	FLT3548007

OEM Part #	Fleetrite Part #
20801-0099	FLT3882504
20801-0100	FLT4343912
20801-0102	FLT3548015
20801-0103	FLT3548030
20801-0105	FLT3882503
20801-0106	FLT3882511
20801-0107	FLT3548002
20801-0111	FLT3882502
20801-0112	FLT3816412
20801-0115	FLT3882575
20801-0116	FLT4113501
20801-3202	FLT3548005
20801-3204	FLT4343908
20801-3205	FLT4343903
20801-3206	FLT4343919
20801-3404	FLT3582801
20801-3406	FLT3548032
20801-3408	FLT3548018
20801-3412	FLT4343908
20801-3413	FLT4343913
20801-3414	FLT4343904
20801-3416	FLT3548028
20801-3417	FLT4343914
20801-3418	FLT3548010
20801-3419	FLT3548007
20801-3420	FLT4343919
20801-3421	FLT3548005
20801-3422	FLT4290402
20801-3423	FLT3816419
20801-3424	FLT3816407
20801-3425	FLT3816406
20801-3426	FLT3816418
20801-3429	FLT3548033
20801-3430	FLT4343907
20801-3433	FLT3548021
20801-3434	FLT3882505

OEM Part #	Fleetrite Part #
20801-3435	FLT3548001
20801-3436	FLT3548002
20801-3438	FLT3548003
20801-3440	FLT3844918
20801-3441	FLT3548022
20801-3443	FLT3882503
20801-3447	FLT4113508
20801-3448	FLT4113501
20801-3449	FLT4113507
20801-3450	FLT4113502
20801-3451	FLT4139201
20801-3452	FLT4139202
20801-3454	FLT4139208
20801-3455	FLT4113442
20801-3456	FLT4113401
20801-3457	FLT4139301
20801-3458	FLT4139207
20801-3459	FLT4113441
20801-3460	FLT3882509
20801-3461	FLT4139308
20801-3463	FLT4113402
20801-3464	FLT4260004
20801-3465	FLT4260005
20801-3466	FLT4139302
20801-3467	FLT4139307
20801-3468	FLT3844909
20801-3469	FLT4139151
20801-3470	FLT4139107
20801-3472	FLT42904103
20801-3473	FLT4113508
20801-3474	FLT4113501
20801-3475	FLT4113507
20801-3476	FLT4113502
20801-3477	FLT4139201
20801-3478	FLT4139202
20801-3479	FLT4113442

OEM Part #	Fleetrite Part #
20801-3480	FLT4139301
20801-3481	FLT4139207
20801-3482	FLT4113441
20801-3483	FLT4139308
20801-3484	FLT4113402
20801-3485	FLT4139302
20801-3486	FLT4139307
20801-3489	FLT4139107
20801-3490	FLT4139152
20801-3491	FLT4139208
20801-3601	FLT3548002
20801-3602	FLT3548001
20801-3605	FLT3548010
20801-3803	FLT4343916
20801-3804	FLT4343924
20801-3805	FLT3548062
20801-3806	FLT3548006
20801-3807	FLT4343901
20801-3808	FLT3548034
20801-3810	FLT3548055
20801-3811	FLT4343918
20801-3812	FLT3548020
20801-3813	FLT3882511
20801-3814	FLT4343909
20801-3816	FLT4343906
20801-5001	FLT4343906
20801-8000	FLT4343904
20801-8001	FLT4343903
3974081	FLT4139304
3974082	FLT4260021
3974269	FLT4290409
3974310	FLT4139220
3974368	FLT4113504
8028349	FLT4139204
8064468	FLT4343910
8064689	FLT4113446

OEM Part #	Fleetrite Part #
8077550	FLT4113470
8077864	FLT4113568
8082583	FLT4113568
8082585	FLT4113449
8082586	FLT4113469
8082587	FLT4113470
8082600	FLT4113566
8149032	FLT4113566
8164113	FLT4113516
8165097	FLT4139232
8169329	FLT4113441
8174468	FLT4113504
8174686	FLT4113508
8177385	FLT41392103
8177454	FLT4113507
8177804	FLT4139220
8178064	FLT4139201
8179459	FLT4260021
8179771	FLT4139224
8180275	FLT4113443
8181356	FLT4290408
8181628	FLT4290402
8181629	FLT4290404
8181630	FLT4290424
8181632	FLT4290433
8181633	FLT4290407
8181635	FLT4290409
8181636	FLT4290418
8181637	FLT4290422
8181638	FLT4290410
8181639	FLT4290419
8181640	FLT4290428
8182058	FLT4139301
8182375	FLT4139202
9053050	FLT3548005
9053051	FLT3548006



www.fleetrite.com

NAVISTAR™